IMPORTANT

IMPORTANT: If you are in any doubt about the contents of this prospectus, you should seek independent professional advice.



Tsit Wing International Holdings Limited
捷榮國際控股有限公司*

(Incorporated under the laws of Bermuda with limited liability)

GLOBAL OFFERING

Number of Offer Shares under the Global Offering	:	239,200,000 Shares (comprising 106,229,312 new Shares and 132,970,688 Sale Shares, subject to the Over-allotment Option)
Number of Hong Kong Offer Shares	:	23,920,000 Shares (including 2,392,000 Employee Reserved Shares, subject to adjustment)
Number of International Offer Shares	:	215,280,000 Shares (comprising 82,309,312 new Shares and 132,970,688 Sale Shares, subject to adjustment and the Over-allotment Option)
Maximum Offer Price	:	HK\$2.19 per Offer Share, plus brokerage of 1.0%, SFC transaction levy of 0.0027% and Hong Kong Stock Exchange trading fee of 0.005% (payable in full on application in Hong Kong dollars, subject to refund)
Nominal value	:	HK\$0.10 per Share
Stock code	:	2119

Sole Global Coordinator



Joint Sponsors



Joint Bookrunners and Joint Lead Managers



Hong Kong Exchanges and Clearing Limited, The Stock Exchange of Hong Kong Limited and Hong Kong Securities Clearing Company Limited take no responsibility for the contents of this prospectus, make no representation as to its accuracy or completeness and expressly disclaim any liability whatsoever for any loss howsoever arising from or in reliance upon the whole or any part of the contents of this prospectus.

A copy of this prospectus, having attached thereto the documents specified in the section headed "Documents Delivered to the Registrar of Companies and Available for Inspection" in Appendix V to this prospectus, has been registered by the Registrar of Companies in Hong Kong as required by Section 342C of the Companies (Winding Up and Miscellaneous Provisions) Ordinance (Chapter 32 of the Laws of Hong Kong). The Securities and Futures Commission of Hong Kong and the Registrar of Companies in Hong Kong take no responsibility for the contents of this prospectus or any of the other documents referred to above.

The Offer Price is expected to be determined by agreement between the Sole Global Coordinator (for itself and on behalf of the Underwriters) and our Company (for ourselves and on behalf of the Selling Shareholder) on or about Friday, May 4, 2018 (Hong Kong time) and, in any event, not later than Monday, May 7, 2018 (Hong Kong time). The Offer Price will be not more than HK\$2.19 per Offer Share and is currently expected to be not less than HK\$1.50 per Offer Share, unless otherwise announced. Investors applying for the Hong Kong Offer Shares must pay, on application, the maximum Offer Price of HK\$2.19 per Offer Share, together with brokerage of 1.0%, SFC transaction levy of 0.0027% and Hong Kong Stock Exchange trading fee of 0.005%, subject to refund if the Offer Price is less than HK\$2.19 per Offer Share. If, for any reason, the Offer Price is not agreed between our Company (for ourselves and on behalf of the Selling Shareholder) and the Sole Global Coordinator (for itself and on behalf of the Underwriters) on or before Monday, May 7, 2018 (Hong Kong time), the Global Offering (including the Hong Kong Public Offering) will not proceed and will lapse.

The Sole Global Coordinator (for itself and on behalf of the Underwriters), with the consent of our Company (for ourselves and on behalf of the Selling Shareholder), may reduce the indicative Offer Price range stated in this prospectus and/or reduce the number of Offer Shares being offered pursuant to the Global Offering at any time on or prior to the morning of the last day for lodging applications under the Hong Kong Public Offering. In such a case, notices of the reduction of the indicative Offer Price range and/or the number of Offer Shares will be published on the website of the Hong Kong Stock Exchange at www.hkexnews.hk and our website at www.twcoffice.com not later than the morning of the last day for lodging applications under the Hong Kong Public Offering. Further details are set out in the sections headed "Structure of the Global Offering" and "How to Apply for Hong Kong Offer Shares" in this prospectus. Prior to making an investment decision, prospective investors should consider carefully all of the information set out in this prospectus, including the risk factors set out in the section headed "Risk Factors" in this prospectus. The obligations of the Hong Kong Underwriters under the Hong Kong Underwriting Agreement are subject to termination by the Sole Global Coordinator (for itself and on behalf of the Underwriters) if certain grounds arise prior to 8:00 a.m. on the Listing Date. Such grounds are set out in the section headed "Underwriting — Underwriting Arrangements and Expenses — Hong Kong Public Offering — Grounds for termination" in this prospectus. It is important that you refer to that section for further details.

The Offer Shares have not been and will not be registered under the U.S. Securities Act or any state securities law in the United States and may not be offered, sold, pledged or transferred within the United States or to, or for the account or benefit of U.S. persons, except in transactions exempt from, or not subject to, the registration requirements of the U.S. Securities Act. The Offer Shares are being offered and sold outside the United States in offshore transactions in reliance on Regulation S under the U.S. Securities Act.

* For identification purposes only

April 30, 2018

EXPECTED TIMETABLE⁽¹⁾

Latest time for lodging PINK Application Forms at our Company's office at Flats F–J, 11th Floor, Block 1, Kwai Tak Industrial Centre, 15–33 Kwai Tak Street, Kwai Chung, New Territories, Hong Kong.	12:00 noon on Thursday, May 3, 2018
Latest time for completing electronic applications under HK eIPO White Form service through the designated website www.hkeipo.hk ⁽²⁾	11:30 a.m. on Friday, May 4, 2018
Application lists open ⁽³⁾	11:45 a.m. on Friday, May 4, 2018
Latest time for lodging WHITE and YELLOW Application Forms	12:00 noon on Friday, May 4, 2018
Latest time for completing payment of HK eIPO White Form applications by effecting internet banking transfer(s) or PPS payment transfer(s)	12:00 noon on Friday, May 4, 2018
Latest time for giving electronic application instructions to HKSCC ⁽⁴⁾	12:00 noon on Friday, May 4, 2018
Application lists close ⁽³⁾	12:00 noon on Friday, May 4, 2018
Expected Price Determination Date ⁽⁵⁾	Friday, May 4, 2018
Announcement of (i) the Offer Price, (ii) the level of indications of interest in the International Offering, (iii) the level of applications in the Hong Kong Public Offering (including the Employee Preferential Offering) and (iv) basis of allocation of the Hong Kong Offer Shares under the Hong Kong Public Offering (including the Employee Preferential Offering) will be published on the website of the Hong Kong Stock Exchange at www.hkexnews.hk and our website at www.twcoffee.com from	Thursday, May 10, 2018

EXPECTED TIMETABLE⁽¹⁾

Results of allocations in the Hong Kong Public Offering (including the Employee Preferential Offering) (with successful applicants' identification document numbers, where appropriate) will be available through a variety of channels as described in the section headed "How to Apply for Hong Kong Offer Shares — 11. Publication of Results" in this prospectus Thursday, May 10, 2018

Results of allocations in the Hong Kong Public Offering (including the Employee Preferential Offering) will be available at www.tricor.com.hk/ipo/result with a "search by ID" function from Thursday, May 10, 2018

Dispatch/collection of Share certificates in respect of wholly or partially successful applications pursuant to the Hong Kong Public Offering (including the Employee Preferential Offering) on or before⁽⁶⁾ Thursday, May 10, 2018

Dispatch/collection of refund cheques and e-Auto Refund payment instructions in respect of wholly or partially successful applications (if applicable) or wholly or partially unsuccessful applications pursuant to the Hong Kong Public Offering (including the Employee Preferential Offering) on or before Thursday, May 10, 2018

Dealings in the Shares on the Hong Kong Stock Exchange expected to commence on 9:00 am on Friday, May 11, 2018

Notes:

- (1) All times refer to Hong Kong local time, except as otherwise stated.
- (2) You will not be permitted to submit your application through the designated website at www.hkeipo.hk after 11:30 a.m. on the last day for lodging applications. If you have already submitted your application and obtained a payment reference number from the designated website prior to 11:30 a.m., you will be permitted to continue the application process (by completing payment of application monies) until 12:00 noon on the last day of lodging applications, when the application lists close.
- (3) If there is a tropical cyclone warning signal number 8 or above, or a "black" rainstorm warning in force in Hong Kong at any time between 9:00 a.m. and 12:00 noon on Friday, May 4, 2018, the application lists will not open on that day. Please refer to the section headed "How to Apply for Hong Kong Offer Shares — 10. Effect of Bad Weather on the Opening of the Application Lists" in this prospectus.
- (4) Applicants who apply for the Hong Kong Offer Shares by giving **electronic application instructions** to HKSCC should refer to the section headed "How to Apply for Hong Kong Offer Shares — 6. Applying by Giving Electronic Application Instructions to HKSCC via CCASS" in this prospectus.

EXPECTED TIMETABLE⁽¹⁾

- (5) The Price Determination Date is expected to be on or about Friday, May 4, 2018 and, in any event, not later than Monday, May 7, 2018 unless otherwise determined between the Sole Global Coordinator (for itself and on behalf of the Underwriters) and our Company (for ourselves and on behalf of the Selling Shareholder). If, for any reason, the Offer Price is not agreed by Monday, May 7, 2018 between our Company (for ourselves and on behalf of the Selling Shareholder) and the Sole Global Coordinator (for itself and on behalf of the Underwriters), the Global Offering will not become unconditional and will lapse.
- (6) Share certificates for the Hong Kong Offer Shares are expected to be issued on Thursday, May 10, 2018 but will only become valid certificates of title provided that the Global Offering has become unconditional in all respects, and neither of the Underwriting Agreements has been terminated in accordance with its terms, prior to 8:00 a.m. on the Listing Date, which is expected to be on or around Friday, May 11, 2018. Investors who trade Shares on the basis of publicly available allocation details before the receipt of Share certificates or before the Share certificates becoming valid certificates of title do so entirely at their own risk.

The above expected timetable is a summary only. You should refer to the sections headed “Structure of the Global Offering” and “How to Apply for Hong Kong Offer Shares” in this prospectus for details of the structure of the Global Offering, including the conditions of the Global Offering, and the procedures for application for the Hong Kong Offer Shares.

CONTENTS

IMPORTANT NOTICE TO INVESTORS

This prospectus is issued by Tsit Wing International Holdings Limited solely in connection with the Hong Kong Public Offering, the Hong Kong Offer Shares and does not constitute an offer to sell or a solicitation of an offer to buy any securities other than the Hong Kong Offer Shares offered by this prospectus pursuant to the Hong Kong Public Offering. This prospectus may not be used for the purpose of, and does not constitute, an offer or invitation in any other jurisdiction or in any other circumstances. No action has been taken to permit a public offering of the Offer Shares or the distribution of this prospectus in any jurisdiction other than Hong Kong. The distribution of this prospectus and the offering and sale of the Offer Shares in other jurisdictions are subject to restrictions and may not be made except as permitted under the applicable securities laws of such jurisdictions pursuant to registration with or authorization by the relevant securities regulatory authorities or an exemption therefrom.

You should rely on the information contained in this prospectus and the Application Forms to make your investment decision. We have not authorized anyone to provide you with information that is different from what is contained in this prospectus. Any information or representation not made in this prospectus must not be relied on by you as having been authorized by us, the Selling Shareholder, the Sole Global Coordinator, the Joint Sponsors, the Joint Lead Managers, the Joint Bookrunners, the Underwriters, any of our or their respective directors, officers or representatives or any other person involved in the Global Offering. Information contained in our website, located at www.twcoffee.com, does not form part of this prospectus.

	<i>Page</i>
Expected Timetable	i
Contents	iv
Summary	1
Definitions	18
Glossary of Technical Terms	34
Forward-Looking Statements	35
Risk Factors	37
Waivers from Strict Compliance with the Listing Rules and Exemption from the Companies (Winding Up and Miscellaneous Provisions) Ordinance	73
Information about this Prospectus and the Global Offering	78

CONTENTS







	<i>Page</i>
Directors and Parties Involved in the Global Offering	82
Corporate Information	86
Industry Overview	88
Regulatory Overview	100
History, Development and Corporate Structure	118
Business	138
Financial Information	221
Relationship with Our Controlling Shareholders	283
Continuing Connected Transactions	291
Cornerstone Investors	300
Share Capital	304
Substantial Shareholders	307
Directors and Senior Management	309
Future Plans and Use of Proceeds	324
Underwriting	330
Structure of the Global Offering	342
How to Apply for Hong Kong Offer Shares	355
Appendix I — Accountants' Report	I-1
Appendix II — Unaudited Pro Forma Financial Information	II-1
Appendix III — Summary of the Constitution of our Company and Bermuda Company Law	III-1
Appendix IV — Statutory and General Information	IV-1
Appendix V — Documents Delivered to the Registrar of Companies and Available for Inspection	V-1
Appendix VI — Intellectual Property Rights	VI-1

SUMMARY

This summary aims to give you an overview of the information contained in this prospectus. As it is a summary, it does not contain all the information that may be important to you. You should read the whole document before you decide to invest in the Offer Shares. Some of the particular risks in investing in the Offer Shares are set out in the section headed “Risk Factors” in this prospectus. You should read this section carefully before you invest in Offer Shares.

OVERVIEW

We are a leading integrated B2B coffee and black tea solutions provider in Hong Kong, Macau and the PRC with an established food products business. Our 85-year heritage originates from an outlet providing coffee roasting and trading of coffee and tea in 1932. Since then, we have grown into a well-trusted brand in Hong Kong, Macau and the PRC providing one-stop coffee and tea solutions services to commercial customers that cover the entire coffee and tea procurement, processing and distribution value chain, with an expertise on Hong Kong-style milk tea. While in the PRC, we have established a stable beverage solutions business, which we believe has good growth potential as reflected in our financial results for the year ended December 31, 2017. With a view to better serve our customers, we broadened our business scope and commenced our frozen meat business in Hong Kong and the PRC in 2013 and frozen processed food in Hong Kong in 2015 and the PRC in 2016.

We have developed a stable and diverse group of customers that include franchised business of McDonald’s in the PRC and Hong Kong , Yoshinoya, 7-Eleven , Café de Coral , Fairwood , Tsui Wah, Tai Hing  and Spaghetti House . Together with our customers, we catered to generations of end consumers in the regions we serve and successfully evolved to meet changing consumer tastes. At the same time, we implemented various measures that we believe contributed to the advancement of the coffee and black tea culture in Hong Kong, including providing free-rental coffee machines along with our coffee products since 2003 to fast food chains and Cha Chaan Teng in Hong Kong to serve fresh brewed coffee and espresso. We have accounted for the income from the lease of coffee machines under such pricing arrangements within the revenue from the sales of goods and the rental income from such packaged sales arrangement is immaterial to the Group’s revenue during the Track Record Period, and we waive the rental charge of coffee machines only if customers’ purchases of coffee beans meet the minimum amount under the related pricing arrangements. We believe such measures not only elevated the consumer experience, but also enhanced our brand recognition amongst our customers and/or their end-users, which in turn, strengthened our business growth and leading market position. For further details on the revenue recognition policy, please refer to “Financial Information — Description of Certain Components of Consolidated Statements of Profit or Loss and Other Comprehensive Income” and the Accountants’ Report as set out in Appendix I to this prospectus.

According to Frost & Sullivan, we were the largest B2B coffee and black tea solutions provider in Hong Kong in 2016 with 24.5% of the market share in terms of B2B revenue, and the third and fourth largest B2B coffee and black tea solutions provider in Macau and

SUMMARY

the PRC, respectively, in 2016 with 9.9% and 1.2% of the market share, respectively, in terms of B2B revenue. In addition, in 2016, we were the largest Sri Lanka tea importer in terms of volume in Hong Kong and the third-largest Sri Lanka tea importer in terms of volume in the PRC. In 2017, coffee sold by us can be made into 253.2 million to 337.7 million cups of coffee per year and between 693,800 to 925,100 cups of coffee per day (assuming nine to 12 grams of coffee is applied to produce each cup), while tea sold by us can be made into 302.4 million to 403.2 million cups of milk tea per year and 828,500 to 1,104,600 cups of milk tea per day (assuming nine to 12 grams of tea is applied to produce each cup of milk tea).

We take pride in being a trusted coffee and tea solutions provider to our customers. We believe our success is based on our proactive approach towards understanding our customers' needs, adapting our operation to meet their demand and applying our wealth of industry knowledge to forming economical solutions quickly. In particular, to help our customers attain their goals, we leverage off our well-established network of renowned suppliers to access a comprehensive portfolio of quality-assured materials. While at the product execution stage, we reach to our rich roasting, blending and mixing experience and rely on our automated production system to deliver safe and reliable tailor-made products in mass volumes. We have the ability to simultaneously produce different products that are packaged for wholesale and/or assembling them in retail ready portions to fulfill the demands of our diverse customer base. Moreover, to make sure our proposed coffee and tea solutions can be implemented consistently with the desired effect, we do not only assist our customers to form the product but also provide the essential coffee equipment and design the details of the preparation techniques.

Our diverse customer base gives us a multi-channel distribution network that can reach approximately 60% of the food outlets in Hong Kong, which include approximately up to 77.6%, 70.3% and 78.7% market coverage of fast food stores, Cha Chaan Tengs and cafes respectively, in 2016. As our products are consumed by a sizeable population on a daily basis, we have an unwavering commitment to food safety and consistent service quality. Our stringent quality control process starts with sourcing from suppliers with internationally-accredited quality certifications, and journeys through our operations in Hong Kong and the PRC under the strict commitment to internationally recognized standards, including HACCP, ISO 9001: 2008, ISO 14001: 2004 and ISO 22000: 2005. We have also installed automated and digitized systems that monitor and instantly record production data to ensure full traceability by pack. Our commitment to food safety has been recognized by leading food and beverage service providers, including franchised business of McDonald's in the PRC and Hong Kong, known to enforce stringent quality standards.

We broadened our business scope to provide food supplies to our B2B customers and commenced our frozen meat business in Hong Kong and the PRC in 2013, and our frozen processed food business in Hong Kong in 2015 and in the PRC in 2016. Please see “— Our Beverage Solutions and Food Products Business” in this section for further details. Going forward, we aim to provide frozen meat and frozen processed food to our customers and integrate such products into our customers' central kitchen. In addition, we entered into a strategic cooperation agreement in July 2017 with a leading food provider, NH Foods,

SUMMARY

which has operations in about 90 locations in 19 countries and regions, to jointly develop the food products market in Hong Kong, Macau and the PRC. We believe that our market knowledge and well-established customer base combined with NH Foods's expertise in food products, experience and resource strengthens our product portfolio and positions us well to develop targeted markets in Hong Kong, Macau and the PRC, including meeting the demand of tailor made products to our B2B customers in the fast food market. Furthermore, we entered into a memorandum of understanding with F&N in April 2018 to explore business and product development opportunities for the supply, distribution, co-branded promotion and co-development of beverage products and/or beverage solutions.

We were listed on SGX-ST in December 2001 and delisted on October 3, 2013. Our Directors consider Hong Kong to be a suitable place for Listing as they believe that a listing in Hong Kong will not only contribute to opportunities for future fund-raising and potential improvement in the trading liquidity and valuation of our Shares, but also provide better synergy for our Group in terms of branding and raising our corporate profile. For further details on delisting from SGX-ST, please refer to "History, Development and Corporate Structure — Delisting from SGX-ST" in this prospectus. For further details on the reasons for current listing in Hong Kong, please refer to "History, Development and Corporate Structure — Application for Listing on the Hong Kong Stock Exchange" in this prospectus.

For the years ended December 31, 2015, 2016 and 2017, our revenue generated from beverage solutions business was HK\$634.7 million, HK\$639.2 million and HK\$711.3 million, respectively, which accounted for approximately 75.7%, 75.2% and 74.5% of our total revenue for the same periods, respectively. In addition, we sold food products, which included frozen meat and frozen processed food. For the years ended December 31, 2015, 2016 and 2017, our revenue generated from food products business was HK\$203.4 million, HK\$210.5 million and HK\$243.3 million, respectively, which accounted for 24.3%, 24.8% and 25.5% of our total revenue for the same periods, respectively.

OUR BEVERAGE SOLUTIONS AND FOOD PRODUCTS BUSINESS

We provide a one-stop service for our commercial customers that cover marketing analysis, recipe development, sourcing, production, marketing and after sales services which include regular customer training and equipment maintenance. Such services are provided through our five operational modules, which include (i) menu management and recipe development, (ii) strong global sourcing network, (iii) automated product execution, (iv) sophisticated distribution system for diverse customers, and (v) comprehensive customer services. For further details, please refer to the section headed "Business — Our Brand/Philosophy — Our beverage solutions business model" in this prospectus.

We entered the frozen meat market through an acquisition by Whole Sun of the business and assets of a frozen meat supplier in Hong Kong in 2013. For details, please refer to the section headed "History, Development and Corporate Structure — Our Corporate Development — (a) Major subsidiaries of TWIC — Whole Sun" in this prospectus. We have a stable group of frozen meat customers, with whom on average we have over four years of business relationship. We believe such established relationship is built on our effort to

SUMMARY

follow market development closely and to provide cost-competitive frozen meat products to wholesalers who cater to fast food chains and Cha Chaan Teng. In addition, in 2015, as part of our horizontal expansion, we started trading and selling frozen processed food of renowned brands, and further launched our frozen processed food brand, “Papa Chef” in 2016 under OEM arrangement with a view to capturing the growth opportunities in the frozen processed food market. For further details regarding our OEM contractors, please refer to the section headed “Business — OEM Contractors” in this prospectus. Going forward, we aim to provide frozen meat and frozen processed food to our customers and integrate such products into our customer’s central kitchen. For further details of our brand/philosophy, please refer to the section headed “Business — Our Brand/Philosophy” in this prospectus.

In March 2017, a meat adulteration scheme was uncovered in Brazil. While we source some of our frozen meat products from Brazil, our business was not directly affected by this incident as none of our suppliers was among the Brazilian plants banned by the government authorities. For further details of the impact of the Brazilian meat adulteration scheme, please refer to “Risk Factors — Risks Relating To Our Business — Any health or food safety problems or negative publicity and media reports related to our raw materials, our products, our operations or the general beverage and frozen meat and frozen processed food industry could materially and adversely affect our business, reputation and our ability to sell our products.” in this prospectus.

PRODUCTION

We process our (i) roasted and ground coffee products, (ii) blended tea products and (iii) All-In-One coffee, tea and a coffee and milk tea mix drink, yuan yeung, products (collectively referred to as “**All-In-One Beverage Mix**” products) at our own production facilities in Hong Kong and Dongguan, the PRC, while our milk and frozen processed food products are produced under OEM arrangement by contract manufacturers in Thailand, Lithuania and the PRC. We do not produce meat products and only import and then directly re-sell such products to wholesalers. For further details regarding our production and OEM arrangement, please refer to the section headed “Business — Production” and “Business — OEM Contractors” in this prospectus.

OUR CUSTOMERS

Over the years, we have built a stable and diversified group of customers that include multinational fast food chains and established Cha Chaan Teng that serve the needs of the mass market, and luxury hotels, airlines and amusement parks that demand for specialized products to cater to the tastes of a niche segment. We have on average over ten years of experience supplying to our major customers. For the years ended December 31, 2015, 2016 and 2017, sales to our five largest customers collectively accounted for 25.7%, 25.3% and 24.3% of our total revenue during the same periods, respectively, and sales to our largest customer accounted for 15.0%, 14.1% and 12.8% of our total revenue during the same periods, respectively. As of the Latest Practicable Date, our relationships with our five

SUMMARY

largest customers during the Track Record Period ranged between seven to over ten years. For further details of our customers, please refer to the section headed “Business — Customers” in this prospectus.

The table below sets out the breakdown of our revenue derived from direct sales and distributors for the periods indicated:

	Year ended December 31,					
	2015		2016		2017	
	(HK\$'000)	% of total	(HK\$'000)	% of total	(HK\$'000)	% of total
Beverage Solutions	634,723	75.7%	639,175	75.2%	711,349	74.5%
— Direct sales	574,380	68.5%	575,292	67.7%	631,821	66.2%
— Distributors	60,343	7.2%	63,883	7.5%	79,528	8.3%
Food Products	203,429	24.3%	210,545	24.8%	243,261	25.5%
— Direct sales	203,429	24.3%	210,545	24.8%	243,261	25.5%
Total	838,152	100%	849,720	100%	954,610	100%

SALES AND MARKETING

Our sales and marketing team is primarily responsible to plan and execute marketing strategies, including product management, product development, market research, corporate relations and marketing communications activities, such as directing advertising agencies in the production of media advertising planning, coordinating sales promotions and organizing exhibitions. To support our business development, we utilize a business intelligence system, the QlikView Business Discovery Platform, or QlikView, to identify new business opportunities within our existing customer base. We apply the system to analyze sales data, including quantity, types of products and frequency of orders, from our customers. Through the system, we identify new cross-selling opportunities and modify product offering to existing customers based on individual and industry analyses on sales trends and business operation. For further details of our sales and marketing, please refer to the section headed “Business — Sales and Marketing” in this prospectus.

DELIVERY AND LOGISTICS

We utilize our in-house delivery capability as well as third party logistics service providers to ensure efficient delivery of our products. We have a well-established logistics system with a delivery capability of within 24 hours for a wide-range of customers in Hong Kong. During the Track Record Period and up to the Latest Practicable Date, we did not experience any material delay in delivery of our products and we believe the use of our in-house logistics team as well as third party logistics service providers will ensure sufficient transportation capacity for our future expansion. For further details of our delivery and logistics, please refer to the section headed “Business — Delivery and Logistics” in this prospectus.

SUMMARY

OUR SUPPLIERS AND PROCUREMENT OF RAW MATERIALS

We have a stable sourcing network that includes many globally renowned major suppliers with whom we have over ten years of relationship. Through such suppliers, we have access to quality raw materials from different continents across various climate zones at designated delivery times at competitive prices. In addition, through close collaboration and frequent communication with our major suppliers, we believe we have been able to better forecast raw material price changes and manage procurement costs. In turn, such value-added service helps our customers and us to better manage financial risk associated with raw material price changes. We will continue to enhance the breadth and depth of our supply network by engaging more globally recognized suppliers while deepening our relationship with our existing supply channels. For the years ended December 31, 2015, 2016 and 2017, purchases from our five largest suppliers collectively accounted for approximately 44.3%, 43.2% and 44.3% of our total cost of sales during the same periods, respectively, and purchases from our largest supplier accounted for approximately 24.5%, 22.5% and 22.8% of our total cost of sales during the same periods, respectively. For further details of our procurement of raw materials and suppliers, please refer to the section headed “Business — Procurement of Raw Materials and Suppliers” in this prospectus.

QUALITY MANAGEMENT

As a food and beverage provider, our key focus is to ensure that our products are safe and of high quality. We implement and maintain stringent quality control in all aspects to ensure the safety and quality of our products throughout our procurement, production, storage and distribution. We maintain internationally recognized standards of quality control and hygiene to ensure that only quality products are produced from our production facilities. Moreover, we have installed automated and digitized systems to ensure product traceability by pack and minimize offline manual operation.

We have adopted the HACCP processes at our production facilities. We were awarded the HACCP certificates by SGS Hong Kong Limited in Hong Kong since December 2006 and by China Quality Certification Centre in the PRC since November 2011 for our production of coffee and tea-related products. In addition, we have been accredited with ISO 9001: 2008 in Hong Kong and the PRC, since 2006 and 2011, respectively, as well as ISO 22000: 2005 in Hong Kong since 2008 and in the PRC since 2011 for our coffee and tea production. For further details of our quality management, please refer to the section headed “Business — Quality Management” in this prospectus.

SUMMARY

OUR COMPETITIVE STRENGTHS

- We are a leading and trusted integrated B2B coffee and black tea solutions provider in Hong Kong, Macau and the PRC with 85 years of heritage.
- We have a strong beverage customizing capability and an established food products business supported by a worldwide sourcing network.
- We have a stable and diversified customer base supported by a well-established multi-channel distribution network with proven ability to capture new markets.
- We have a strong track record that is enhanced by integration of advanced quality control and data analysis system that also facilitates business development.
- We have an experienced and high caliber management team with valuable know-how supported by full adoption of modern management system.

OUR BUSINESS STRATEGIES

- Further strengthen our leading position in the integrated B2B coffee and black tea solutions market in Hong Kong, deepen our penetration in the PRC, expand our business in Southeast Asia, and enhance our brand recognition and awareness.
- Continue to strengthen our frozen meat and frozen processed food products business and expand our product offerings.
- Continue to strengthen our sourcing capability and strengthen our vendor selection process.
- Seek to upgrade our production facilities and further enhance our production capabilities.

SUMMARY

SUMMARY OF FINANCIAL INFORMATION

The following tables set out summaries of selected consolidated financial information of our Group for the years ended December 31, 2015, 2016 and 2017, which is extracted from, and should be read in conjunction with our financial information (including the notes thereto) set out in, the Accountants' Report as set out in Appendix I to this prospectus:

Summary of our consolidated statements of profit or loss:

	Year ended December 31,		
	2015	2016	2017
	(HK\$'000)	(HK\$'000)	(HK\$'000)
CONTINUING OPERATIONS			
Revenue	838,152	849,720	954,610
Cost of sales	<u>(591,748)</u>	<u>(575,626)</u>	<u>(664,996)</u>
Gross profit	246,404	274,094	289,614
Other income and gains, net	17,277	17,061	3,998
Selling and distribution expenses	(97,480)	(108,890)	(112,245)
Administrative expenses	(89,896)	(86,774)	(109,743)
Other expenses, net	(12,000)	(9,844)	(3,325)
Finance costs	<u>(4,875)</u>	<u>(4,006)</u>	<u>(4,126)</u>
Profit before tax from continuing operations	59,430	81,641	64,173
Income tax expense	<u>(12,843)</u>	<u>(17,401)</u>	<u>(15,799)</u>
Profit for the year from continuing operations	46,587	64,240	48,374
DISCONTINUED OPERATION			
(Loss)/profit for the year from a discontinued operation	<u>(7,131)</u>	<u>1,463</u>	<u>—</u>
Profit for the year	<u>39,456</u>	<u>65,703</u>	<u>48,374</u>

Our other income and gains, net, was HK\$17.3 million and HK\$17.1 million for 2015 and 2016, respectively, primarily reflecting one-time compensations we received from a milk supplier due to product quality issues in 2015 and from a settled litigation relating to our trademark in 2015 and 2016. For further details, please refer to the section headed "Financial Information — Description of Certain Components of Consolidated Statements of Profit or Loss and Other Comprehensive Income — Other income and gains, net" in this prospectus.

SUMMARY

Our net profit decreased from HK\$65.7 million for 2016 to HK\$48.4 million for 2017, which was primarily due to consultancy and professional fees incurred in relation to our Global Offering and decrease in other income and gains for the year.

Our key consolidated balance sheet items as of the dates indicated:

	As of December 31,		
	2015 (HK\$'000)	2016 (HK\$'000)	2017 (HK\$'000)
Non-current assets	181,111	151,451	147,473
Current assets	383,567	439,913	433,988
Current liabilities	235,877	245,784	291,960
Net current assets	147,690	194,129	142,028
Non-current liabilities	64,697	48,282	57,441
Net assets	264,104	297,298	232,060
EQUITY			
Equity attributable to owners of the parent	247,366	279,253	214,169
Non-controlling interests	<u>16,738</u>	<u>18,045</u>	<u>17,891</u>
Total equity	<u>264,104</u>	<u>297,298</u>	<u>232,060</u>

Our consolidated cash flows for the periods indicated:

	Year ended December 31,		
	2015 (HK\$'000)	2016 (HK\$'000)	2017 (HK\$'000)
Net cash flows generated from operating activities	82,693	118,694	26,768
Net cash flows used in investing activities	(19,952)	(111,971)	(26,572)
Net cash flows used in financing activities	<u>(88,168)</u>	<u>(17,663)</u>	<u>(3,689)</u>
Net decrease in cash and cash equivalents	(25,427)	(10,940)	(3,493)
Cash and cash equivalents at beginning of year	86,864	59,924	48,100
Effect of foreign exchange rate changes, net	<u>(1,513)</u>	<u>(884)</u>	<u>1,006</u>
Cash and cash equivalents at end of year	<u>59,924</u>	<u>48,100</u>	<u>45,613</u>

SUMMARY

Our net cash generated from operating activities decreased from HK\$118.7 million for 2016 to HK\$26.8 million for 2017, which was primarily due to (i) decrease in profit before tax for 2017 as a result of consultancy and professional fees incurred in relation to our Global Offering, (ii) increase in inventories in 2017 mainly as we (A) stored more raw materials for tea products in light of the forecasted price increase, (B) increased raw materials for instant products to fulfill sales demand of a major customer, and (C) increased stock of food products to diversify the product variety, and (iii) increase in trade receivables in 2017 primarily because of growth in scale of our business.

Our key financial ratios for the periods and as of the dates indicated:

	As of or for the year ended		
	December 31,		
	2015	2016	2017
Current Ratio	1.6	1.8	1.5
Quick Ratio	0.9	1.2	0.8
Gearing Ratio ⁽¹⁾	70.7%	62.3%	89.4%
Return on Equity	16.7%	23.3%	21.5%
Return on Assets	7.0%	11.1%	8.3%
Net Profit Margin — With loss/profit from a Discontinued Operation	4.7%	7.7%	5.1%
Net Profit Margin — Continuing Operations	5.6%	7.6%	5.1%
Net Debt to Equity Ratio	46.5%	45.0%	68.1%

Note:

- (1) Gearing ratio equals total debt divided by equity attributable to owners of the parent. Our total debt represents interest-bearing bank borrowings.

Our gearing ratio increased from 62.3% as of December 31, 2016 to 89.4% as of December 31, 2017 primarily because of increase in our total interest-bearing bank borrowings for working capital purpose and decrease in our total equity attributable to owners of the parent, which in turn, is a result of a decrease in our reserves because of dividend payment. For further details of our key financial ratios, please refer to the section headed “Financial Information — Financial Ratios” in this prospectus.

SUMMARY

The following table sets out a breakdown of our revenue, gross profit and gross profit margin by product category for the periods indicated:

	Year ended December 31,											
	2015				2016				2017			
	Revenue (HK\$'000)	% of total	Gross Profit (HK\$'000)	Gross Profit Margin	Revenue (HK\$'000)	% of total	Gross Profit (HK\$'000)	Gross Profit Margin	Revenue (HK\$'000)	% of total	Gross Profit (HK\$'000)	Gross Profit Margin
Beverage Solutions	634,723	75.7%	237,613	37.4%	639,175	75.2%	259,821	40.6%	711,349	74.5%	264,334	37.2%
— Coffee	194,654	23.2%	87,967	45.2%	189,676	22.3%	93,252	49.2%	198,033	20.7%	87,588	44.2%
— Tea	188,738	22.5%	92,648	49.1%	190,962	22.5%	94,043	49.2%	228,676	24.0%	99,539	43.5%
— Milk	80,082	9.6%	12,308	15.4%	92,547	10.9%	27,055	29.2%	97,009	10.2%	24,082	24.8%
— Others												
— Groceries and others ⁽¹⁾	85,894	10.2%	16,591	19.3%	81,338	9.6%	15,909	19.6%	87,669	9.2%	18,235	20.8%
— FMCG (i.e. All-In-One Beverage Products) and instant beverage mix ⁽²⁾	49,504	5.9%	16,340	33.0%	48,339	5.7%	15,984	33.1%	54,476	5.7%	18,845	34.6%
— Monin products	24,826	3.0%	8,495	34.2%	26,062	3.1%	9,598	36.8%	28,418	3.0%	10,647	37.5%
— Coffee and tea machines	11,025	1.3%	3,264	29.6%	10,251	1.1%	3,980	38.8%	17,068	1.7%	5,398	31.6%
Food Products	203,429	24.3%	8,791	4.3%	210,545	24.8%	14,273	6.8%	243,261	25.5%	25,280	10.4%
— Frozen meat	201,909	24.1%	8,497	4.2%	202,211	23.8%	12,916	6.4%	226,579	23.7%	21,124	9.3%
— Frozen processed food	1,520	0.2%	294	19.3%	8,334	1.0%	1,357	16.3%	16,682	1.8%	4,156	24.9%
Total	838,152	100%	246,404	29.4%	849,720	100%	274,094	32.3%	954,610	100%	289,614	30.3%

Notes:

- Our groceries and others sales primarily include sales of Lipton yellow label tea.
- Our retail sales equals to our FMCG sales, which amounted to approximately HK\$10.0 million, HK\$10.3 million and HK\$10.5 million for the years ended December 31, 2015, 2016 and 2017, respectively.

The table below sets out a breakdown of our revenue, gross profit and gross profit margin categorized by business segments and by geographical sales for the periods indicated:

	Year ended December 31,											
	2015				2016				2017			
	Revenue (HK\$'000)	% of total	Gross Profit (HK\$'000)	Gross Profit Margin	Revenue (HK\$'000)	% of total	Gross Profit (HK\$'000)	Gross Profit Margin	Revenue (HK\$'000)	% of total	Gross Profit (HK\$'000)	Gross Profit Margin
Beverage Solutions	634,723	75.7%	237,613	37.4%	639,175	75.2%	259,821	40.6%	711,349	74.5%	264,334	37.2%
— Hong Kong	418,048	49.9%	168,628	40.3%	422,548	49.7%	179,504	42.5%	458,610	48.0%	182,623	39.8%
— PRC	196,771	23.5%	60,251	30.6%	199,822	23.5%	73,269	36.7%	234,387	24.6%	74,423	31.8%
— Macau	12,067	1.4%	4,917	40.7%	11,387	1.3%	4,309	37.8%	11,153	1.2%	4,039	36.2%
— Others ⁽¹⁾	7,837	0.9%	3,817	48.7%	5,418	0.7%	2,739	50.6%	7,199	0.7%	3,249	45.1%
Food Products	203,429	24.3%	8,791	4.3%	210,545	24.8%	14,273	6.8%	243,261	25.5%	25,280	10.4%
— Hong Kong	194,670	23.2%	9,032	4.6%	206,072	24.3%	14,305	6.9%	238,743	25.0%	24,341	10.2%
— PRC	8,759	1.1%	(241)	-2.8%	4,473	0.5%	(32)	-0.7%	4,518	0.5%	939	20.8%
Total	838,152	100%	246,404	29.4%	849,720	100%	274,094	32.3%	954,610	100%	289,614	30.3%

Note:

- Others mainly include sales to Australia, Canada, Malaysia, Philippines and Taiwan.

SUMMARY

Our gross profit margin decreased from 32.3% for 2016 to 30.3% for 2017, which was primarily due to increase in the average procurement price of coffee bean, processed tea leaves and milk. For further details, please refer to section headed “Financial Information — Description of Certain Components of Consolidated Statements of Profit or Loss and Other Comprehensive Income — Gross profit and gross profit margin” in this prospectus.

The following table sets out our average selling price and sales volume by product category for the periods indicated:

	Year ended December 31,					
	2015		2016		2017	
	ASP	Vol.	ASP	Vol.	ASP	Vol.
	(HK\$)	('000)	(HK\$)	('000)	(HK\$)	('000)
Beverage Solutions						
— Coffee (lbs)	30.4	6,404	29.4	6,450	29.6	6,700
— Tea (lbs)	27.2	6,930	27.2	7,017	28.6	8,000
— Milk (cartons)	275.5	291	269.5	343	262.4	370
Food Products						
— Frozen meat (kg)	31.7	6,374	28.9	6,987	32.6	6,957
— Frozen processed food (kg)	73.6	21	65.0	128	63.9	261

Though our average selling price for coffee and milk decreased by 2.6% and 4.8% from 2015 to 2017, respectively, the revenue for our beverage solutions segment grew from 2015 to 2017 primarily because of an increase in sales volume of our coffee, tea and milk products. For further details on the decrease in average selling price, please refer to the section headed “Financial Information — Description of Certain Components of Consolidated Statements of Profit or Loss and Other Comprehensive Income — Gross profit and gross profit margin — Beverage Solutions” in this prospectus. For further details on the increase in sales volume, please refer to “Financial Information — Description of Certain Components of Consolidated Statements of Profit or Loss and Other Comprehensive Income — Revenue” in this prospectus.

UTILIZATION RATES

As of the Latest Practicable Date, we have a production facility in Hong Kong and another in Dongguan, the PRC. The utilization rate in our production facility in Hong Kong for coffee products was 100%, 104% and 101% for the years ended December 31, 2015, 2016 and 2017, respectively, while the utilization rate of our Dongguan production facility for coffee products was 69%, 70% and 83% for the years ended December 31, 2015, 2016 and 2017, respectively, which was generally lower. The difference is mainly a result of: (i) we establishing a production capacity in Dongguan that is larger than our immediate needs in preparation for future expansion, and (ii) our plan to gradually shift some of our production from Hong Kong to Dongguan as our production facilities in Hong Kong have been in high utilization and our major facilities in Hong Kong have on average been in use

SUMMARY

for over ten years. The utilization rate in our production facility in Hong Kong for tea products was 96%, 90% and 86%, respectively, while the utilization rate of our Dongguan production facility for tea products was 86%, 63% and 53%, respectively, for the years ended December 31, 2015, 2016 and 2017. The decrease in the utilization rate of tea production lines in the PRC during 2016 and 2017 is primarily due to the completion of construction of tea processing plant in 2015, which commenced operation in 2016 and contributed to the increase in production capacity in 2016 and 2017. Please refer to the section headed “Business — Production — Production Facilities” in this prospectus for further details.

OUR CONTROLLING SHAREHOLDERS

Immediately following the completion of the Global Offering, Mr. Wong, being our Controlling Shareholder, will indirectly, through Hero Valour, hold approximately 66.96% of our issued Shares (without taking into account any Shares which may be allotted and issued upon the exercise of the Over-allotment Option and the options which have been granted under the Pre-IPO Share Option Scheme or which may be granted under the Share Option Scheme). Our Controlling Shareholders do not have any interest in a business which competes with, or is likely to compete with, our business, whether directly or indirectly. In order to avoid such competition, each of our Controlling Shareholders has entered into the Deed of Non-competition in favour of our Company. For further details of our Controlling Shareholders, please refer to the section headed “Relationship with our Controlling Shareholders” in this prospectus.

EMPLOYEE PREFERENTIAL OFFERING

Up to 2,392,000 Employee Reserved Shares (representing 10% of the total number of Hong Kong Offer Shares being initially offered under the Hong Kong Public Offering) are available for subscription by the Eligible Employees on a preferential basis. Our Directors and directors of any of our subsidiaries and their respective affiliates shall not apply for Employee Reserved Shares under the Employee Preferential Offering, and they shall not apply for Hong Kong Offer Shares as members of the public in the Hong Kong Public Offering. All Eligible Employees may apply for Hong Kong Offer Shares in the Hong Kong Public Offering and the Employee Preferential Offering. For further details, please refer to the section headed “How to Apply for Hong Kong Offer Shares” in this prospectus.

LISTING EXPENSES

We incurred Listing expenses (excluding underwriting commission) of HK\$28.7 million during the Track Record Period, of which HK\$25.0 million was recognized as administrative expenses and the remainder will be deducted from equity upon the Listing. We expect to incur further Listing expenses of HK\$17.0 million, including underwriting commission (assuming an Offer Price of HK\$1.84, being the mid-point of the Offer Price range stated in this prospectus), of which HK\$8.1 million will be recognized as administrative expenses for the year ending December 31, 2018, and the remainder will be deducted from equity upon the Listing. Listing expenses incurred for engagement of professional parties in connection with the Listing and the underwriting commission relating to underwriting the new Shares of the Global Offering are to be borne by our

SUMMARY

Company as all professional services rendered in connection with the Listing are for our Company's benefits and interests to be brought by its listing status. Our Company will not have any interest in the sale of the Sale Shares and therefore any underwriting commission, fees and expenses in that regard will be borne by the Selling Shareholder.

OFFERING STATISTICS

Number of Offer Shares	:	239,200,000 Shares (comprising 106,229,312 new Shares and 132,970,688 Sale Shares, subject to the Over-allotment Option)
Over-allotment Option	:	Up to 15.0% of our initial Offer Shares
Offer Price per Share	:	HK\$1.50 to HK\$2.19 per Share
Offering structure	:	90% International Offering and 10% Hong Kong Public Offering (subject to reallocation and the Over-allotment Option)

	Based on an Offer Price of HK\$1.50	Based on an Offer Price of HK\$2.19
Market Capitalization	HK\$1,086.0 million	HK\$1,585.5 million
Unaudited pro forma adjusted net tangible assets per Share ⁽¹⁾	HK\$0.47	HK\$0.56

Note:

⁽¹⁾ For further details regarding the assumptions used and the calculations method, please refer to the section headed "Appendix II — Unaudited Pro Forma Financial Information" in this prospectus.

DIVIDENDS

During the years ended December 31, 2015, 2016 and 2017, we declared dividends with an amount of HK\$28.1 million, HK\$23.3 million and HK\$122.9 million, respectively, of which HK\$28.1 million, HK\$13.0 million and HK\$14.5 million were respectively settled in cash and nil, HK\$10.3 million, and HK\$108.4 million were respectively set off either against the loans to the ultimate holding company or against the amount due from the ultimate holding company during the years ended December 31, 2015, 2016 and 2017, respectively. We also declared a final dividend for the year of 2017 totalling HK\$10.0 million in January 2018, which was settled in cash, and an interim dividend for the year ending December 31, 2018 totalling HK\$8.1 million in April 2018, which has not been settled as at the Latest Practicable Date. We may distribute dividends in amounts not less than 35% of our net profit for a financial year by way of cash or by other means that we consider appropriate. A decision to declare and pay any dividends would require the approval of the Board and will be at their discretion. In addition, any final dividend for a financial year will be subject to Shareholders' approval. The Board will review our dividend policy from time to time in light of our results of operations, our cash flows, our financial condition, our Shareholders'

SUMMARY

interest, our capital requirements, the general business conditions and strategies, the payment by our subsidiaries of cash dividends to us, and other factors the Board may deem relevant in determining whether dividends are to be declared and paid.

FUTURE PLANS AND USE OF PROCEEDS

We estimate that we will receive net proceeds from the offering of the new Shares as part of the Global Offering of approximately HK\$149.7 million (after deducting the underwriting commissions and estimated expenses payable by us in connection with the Global Offering), assuming the Over-allotment Option is not exercised and an Offer Price of HK\$1.84 per Share, being the mid-point of the Offer Price range stated in this prospectus. We intend to use these net proceeds for the following purposes:

Percentage of Net

Proceeds, approximately Future Plans

40%	Strengthening our ability to provide food and beverage products solutions to our customers, in particular, potential future business or share acquisitions, joint ventures or other strategic arrangements to expand and enhance our product portfolio and to deepen our market penetration;
20%	Capital investments in relation to acquiring, expanding, streamlining or upgrading our manufacturing plants, premises, facilities, equipment or capabilities, with the aim to (i) enhance our production efficiency or reduce our operating costs, and/or (ii) expand our product portfolio;
10%	Expanding our food and beverage business in Southeast Asia (including the costs of setting-up representative offices and commercially-viable strategic acquisition);
10%	Pursuing product customization and development, whether in-house or through collaboration with external parties, and enhancing our technological capabilities;
10%	Bolstering our sales, marketing and advertising efforts to enhance brand recognition and fortify brand loyalty for our products and businesses; and
10%	Working capital and other general corporate purposes.

We estimate that the net proceeds to be received by the Selling Shareholder from the sale of Sale Shares (after deduction of underwriting commissions payable by our Selling Shareholder in relation to the Global Offering, and assuming an Offer Price of HK\$1.84 per Offer Share, being the mid-point of the Offer Price range and assuming the Over-allotment Option is not exercised) are approximately HK\$235.4 million. We will not receive any of the proceeds from the Sale Shares.

SUMMARY

For details, please refer to the section headed “Future Plans and Use of Proceeds” in this prospectus.

CORNERSTONE INVESTORS

We have entered into a strategic cooperation agreement with NH Foods in July 2017 for the sale of frozen, fresh, pre-cooked processed meat and seafood products and a memorandum of understanding with F&N in April 2018 to explore business and product development opportunities for the supply, distribution, co-branded promotion and co-development of beverage products and/or beverage solutions. For details, please refer to the sections headed “History, Development and Corporate Structure — Material Development after Delisting — (g) Entering into strategic cooperation agreement with NH Foods” and “History, Development and Corporate Structure — Material Development after Delisting — (h) Entering into Memorandum of Understanding with F&N” in this prospectus. We have also entered into cornerstone investment agreements with NH Foods and F&N, which NH Foods has agreed to subscribe for our Shares at the Offer Price with an investment amount of one billion Japanese Yen and F&N has agreed to subscribe for a fixed number of 32,000,000 Shares at the Offer Price. The Shares held by NH Foods and F&N shall respectively represent 5.47% (based on the mid-point of the Offer Price range of HK\$1.84 and the indicative exchange rate of one Japanese Yen to HK\$0.0729 as of the Latest Practicable Date) and approximately 4.42% of our total issued Shares immediately upon completion of the Global Offering without taking into account any Shares which may be allotted and issued upon the exercise of the Over-allotment Option and the options which have been granted under the Pre-IPO Share Option Scheme or which may be granted under the Share Option Scheme.

REGULATORY COMPLIANCE AND NON-COMPLIANCE MATTERS

During the Track Record Period and up to the Latest Practicable Date, we were involved in four employee’s compensation and two personal injury claims, one litigation in relation to outstanding trade receivables and one litigation in relation to trademark infringement. For details, please refer to the section headed “Business — Legal Proceedings and Compliance” in this prospectus.

We did not have the real estate ownership certificates for two of our warehouses when we obtained the land use rights of a parcel of land in Dongguan, the PRC. We are in the process to change the nature of the land use rights of a parcel of land in Dongguan, the PRC from collective-owned land to state-owned land through expropriation. During the Track Record Period, there were unauthorized building works (whereby two diesel tanks of less than 2,500 liters in aggregate) on the rooftop of our factory plant in Kwai Chung. For details, please refer to the section headed “Business — Legal Proceedings and Compliance — Non-compliance Matters” in this prospectus.

SUMMARY

SUMMARY OF MATERIAL RISK FACTORS

Our business faces risks including those set out in the “Risk Factors” section in this prospectus. As different investors may have different interpretations and criteria when determining the significance of a risk, you should read the “Risk Factors” section in its entirety before you decide to invest in the Offer Shares. Some of the major risks that we face include: (i) our business largely depends on the strength of our reputation and brand. If we fail to maintain or enhance our brand and reputation due to a failure to maintain effective quality control systems for our products, consumers’ recognition of and trust in us and our products may be materially and adversely affected; (ii) we rely heavily on our suppliers for our raw materials; (iii) increase in raw material prices could materially and adversely affect our business, financial condition and results of operations; and (iv) we do not typically enter into long-term arrangements with our customers, distributors and suppliers.

RECENT DEVELOPMENT AND MATERIAL ADVERSE CHANGE

We declared and paid a final dividend for the year of 2017 in January 2018 that amounted to HK\$10.0 million, which was settled in cash, and declared an interim dividend for the year ending December 31, 2018 in April 2018 that amounted to HK\$8.1 million which has not been settled as at the Latest Practicable Date. Our Directors confirm that, save for the Listing expenses as disclosed in the paragraph headed “Listing Expenses” above which may affect our financial results for 2018, up to the date of this prospectus, there had been no material adverse change in our financial or trading position since December 31, 2017 (being the latest date of which our audited consolidated financial statements were made up as set out in the Accountants’ Report as Appendix I to this prospectus).

DEFINITIONS

In this prospectus, unless the context otherwise requires, the following expressions shall have the following meanings.

“Accountants’ Report”	the report of the Reporting Accountants dated April 30, 2018, the text of which is set out in Appendix I to this prospectus
“affiliate”	any other person, directly or indirectly, controlling or controlled by or under direct or indirect common control with such specified person
“Application Form(s)”	WHITE Application Form(s), YELLOW Application Form(s), GREEN Application Form(s) and PINK Application Form(s) or, where the context so requires, any of them
“Board” or “Board of Directors”	the board of directors of our Company
“BOCI Asia Limited”	a corporation licensed to carry out type 1 (dealing in securities) and type 6 (advising on corporate finance) regulated activities under the SFO
“Bofon”	Bofon International Development (Holdings) Limited (寶豐國際發展(集團)有限公司), formerly known as Bofon International Real Estate Development & Trading Limited (寶豐地產發展貿易有限公司) and Howide Trading Limited (豪惠貿易有限公司), a limited liability company incorporated in Hong Kong on March 12, 1992, a wholly-owned subsidiary of HKDD and beneficially owned by Mr. Wong as to 80% and by Super Active Profits Limited, an Independent Third Party, as to 20%, and is a connected person of our Company
“BOSC International Company Limited”	a corporation licensed to carry out type 1 (dealing in securities), type 4 (advising on securities), type 6 (advising on corporate finance) and type 9 (asset management) of the regulated activities under the SFO
“business day”	a day on which banks in Hong Kong are generally open for normal banking business to the public and which is not a Saturday, Sunday or public holiday in Hong Kong
“BVI”	the British Virgin Islands
“Bye-Laws” or “Bye-laws”	the Bye-Laws of our Company conditionally adopted on December 15, 2017 and effective from the Listing Date, a summary of which is set out in Appendix III to this prospectus, as amended, supplemented, restated or as otherwise modified from time to time

DEFINITIONS

“CCASS”	the Central Clearing and Settlement System established and operated by HKSCC
“CCASS Clearing Participant”	a person admitted to participate in CCASS as a direct clearing participant or general clearing participant
“CCASS Custodian Participant”	a person admitted to participate in CCASS as a custodian participant
“CCASS Investor Participant”	a person admitted to participate in CCASS as an investor participant who may be an individual, joint individuals or a corporation
“CCASS Participant”	a CCASS Clearing Participant, a CCASS Custodian Participant or a CCASS Investor Participant
“CDCL”	Cadiz (Shenzhen) Caterer Company Limited* (嘉迪(深圳)餐飲有限公司), a limited liability company established under the laws of the PRC on October 19, 2011 and an indirect wholly-owned subsidiary of our Company
“CDEL”	Cadiz Enterprises Limited (嘉迪企業有限公司), a limited liability company incorporated in Hong Kong on November 28, 1978 and an indirect wholly-owned subsidiary of our Company
“CDTL”	Cadiz (Shenzhen) Trading Company Limited* (嘉迪(深圳)貿易有限公司), a limited liability company established under the laws of the PRC on July 26, 2012 and an indirect wholly-owned subsidiary of our Company
“China” or “the PRC”	the People’s Republic of China, excluding, for the purpose of this prospectus, Hong Kong, Macau and Taiwan
“China Food and Drug Administration” or “CFDA”	China Food and Drug Administration (中國國家食品藥品監督管理總局)
“Co-lead Managers”	China Galaxy International Securities (Hong Kong) Co., Limited, Prestige Securities Limited and Lego Securities Limited
“COFE”	Tsit Wing Coffee Company, Limited (捷榮咖啡有限公司), formerly known as Tsit Wing Coffee (H.K.) Co., Limited (捷榮咖啡(香港)有限公司), a limited liability company incorporated in Hong Kong on December 10, 1992 and an indirect wholly-owned subsidiary of our Company

DEFINITIONS

“Companies Act” or “Bermuda Companies Act”	the Companies Act 1981 of Bermuda, as amended, supplemented or otherwise modified from time to time
“Companies Ordinance”	the Companies Ordinance (Chapter 622 of the Laws of Hong Kong), as amended, supplemented or otherwise modified from time to time
“Companies (Winding Up and Miscellaneous Provisions) Ordinance”	the Companies (Winding Up and Miscellaneous Provisions) Ordinance (Chapter 32 of the Laws of Hong Kong), as amended, supplemented or otherwise modified from time to time
“Company” or “our Company”	Tsit Wing International Holdings Limited (捷榮國際控股有限公司*), an exempted company incorporated in Bermuda with limited liability on June 13, 2000 and, except where the context otherwise requires, all of its subsidiaries, or where the context refers to the time before it became the holding company thereof, our Company’s present subsidiaries
“Controlling Shareholders”	has the meaning ascribed thereto under the Listing Rules and unless the context requires otherwise, refers to the controlling shareholders of our Company, being Mr. Wong and Hero Valour
“Corporate Governance Code”	the Corporate Governance Code as set out in Appendix 14 to the Listing Rules
“DD(GZ)CC”	Dandy Don’s (Guangzhou) Catering Company Limited* (丹迪當(廣州)餐飲有限公司), a limited liability company established under the laws of the PRC on June 30, 2015, a wholly-owned subsidiary of HKDD and beneficially owned by Mr. Wong as to 80% and by Super Active Profits Limited, an Independent Third Party, as to 20%, and is a connected person of our Company
“Deed of Indemnity”	the deed of indemnity dated December 15, 2017 and entered into between our Controlling Shareholders and our Company, pursuant to which our Controlling Shareholders agree to provide with us certain indemnities, a summary of which is set out in the section headed “Statutory and General Information — E. Other information — 1. Tax and other indemnity” in Appendix IV to this prospectus

DEFINITIONS

“Deed of Non-competition”	the deed of non-competition dated December 15, 2017 and entered into between our Controlling Shareholders and our Company, particulars of which are set out in the section headed “Relationship with our Controlling Shareholders — Deed of Non-competition” in this prospectus
“DGTW”	Dongguan Tsit Wing Food Company Limited* (東莞捷榮食品有限公司), a limited liability company established under the laws of the PRC on September 11, 2009 and an indirect wholly-owned subsidiary of our Company
“DG TWG Heritage”	Dongguan TWG Heritage Food Company Limited* (東莞捷喜食品有限公司), a limited liability company established under the laws of the PRC on January 7, 2014 and an indirect wholly-owned subsidiary of our Company
“Director(s)”	the director(s) of our Company
“Elect Gold”	Elect Gold Ventures Limited, a company incorporated in the BVI with liability limited by shares on December 18, 2013, which is wholly-owned by Mr. Wong through Hero Ace, and is a connected person of our Company
“Elect Gold Group”	Elect Gold and its subsidiaries, namely, Elect Gold, HKDD, Bofon, GZDD and DD(GZ)CC
“EIT”	enterprise income tax
“EIT Law”	the Enterprise Income Tax Law of the PRC, which was promulgated on March 16, 2007, became effective as of January 1, 2008 and amended on February 24, 2017 (《中華人民共和國企業所得稅法》)
“EIT Rules”	the Regulation on the Implementation of the Enterprise Income Tax Law of the PRC, promulgated on December 6, 2007 and became effective on January 1, 2008 (《中華人民共和國企業所得稅法實施條例》)

DEFINITIONS

“Eligible Employee(s)”	all full-time employee(s) (as defined under the Employment Ordinance (Chapter 57 of the Laws of Hong Kong)) of our Group who joined our Group on or before the date of this prospectus and who (a) is at least 18 years of age; (b) has a Hong Kong address; (c) remains as a full-time employee of our Company or any of our subsidiaries, and is not on probation, as at the date of this prospectus; (d) has not tendered resignation or been given notice of termination of employment for any reason other than redundancy or retirement on or before the date of this prospectus; (e) is not the chief executive or director of our Company or our subsidiaries; (f) is neither an, nor a close associate of an, existing Shareholder or beneficial owner, of Shares or of shares of any of our subsidiaries; and (g) is not a core connected person of our Company
“Employee Preferential Offering”	the offer of the Employee Reserved Shares for subscription by the Eligible Employees as described in the section headed “Structure of the Hong Kong Public Offering — The Employee Preferential Offering” in this prospectus and subject to the terms and conditions stated herein and in the PINK Application Forms
“Employee Reserved Shares”	the 2,392,000 Hong Kong Offer Shares being offered by our Company for subscription under the Employee Preferential Offering (representing 10% of the total number of Hong Kong Offer Shares being initially offered under the Hong Kong Public Offering), which are to be allocated out of the Hong Kong Offer Shares
“Employees’ Compensation Ordinance”	the Employees’ Compensation Ordinance (Chapter 282 of the Laws of Hong Kong) as amended, supplemented or otherwise modified from time to time
“ERP”	Enterprise Resource Planning
“F&N”	Fraser and Neave, Limited, a limited liability company incorporated under the laws of Singapore in 1898 whose shares are listed on the SGX-ST (stock code: F99)
“Former Shareholder”	our former Shareholder from October 17, 2014 to March 2, 2016, which is a Japan-based company with business areas covering energy, machinery, chemicals, food, textile, logistics, finance and listed on the Tokyo Stock Exchange
“Frost & Sullivan”	Frost & Sullivan Limited, an independent global market research and consulting company which was founded in 1961 and is based in the United States

DEFINITIONS

“Frost & Sullivan Report”	an industry report prepared by Frost & Sullivan on the B2B coffee and tea market in Hong Kong, the PRC and Macau, the frozen meat market in Hong Kong and the PRC and the frozen processed food market in Hong Kong and the PRC, which was commissioned by our Company
“Global Offering”	the Hong Kong Public Offering and the International Offering
“Global Tea Trading”	Global Tea Trading Company Limited, a limited liability company incorporated in Hong Kong on September 21, 2012 and an indirect wholly-owned subsidiary of our Company and is under the process of deregistration as of the Latest Practicable Date
“Great Guarder”	Great Guarder Limited, a company incorporated in the BVI with liability limited by shares on July 3, 2013 and a direct wholly-owned subsidiary of our Company
“GREEN Application Form(s)”	the application form(s) to be completed by the HK eIPO White Form Service Provider designated by our Company
“Group”, “our Group”, “the Group”, “we”, “us”, “our” or “Tsit Wing”	our Company and our subsidiaries and, in respect of the period before we became the holding company of our present subsidiaries, the businesses operated by such subsidiaries or their predecessors (as the case may be)
“GZDD”	Guangzhou Dandy Don’s Ice-cream Factory Company Limited* (廣州丹迪嚙雪糕廠有限公司), a limited liability company established under the laws of the PRC on April 9, 1994, a wholly-owned subsidiary of HKDD and beneficially owned by Mr. Wong as to 80% and by Super Active Profits Limited, an Independent Third Party, as to 20%, and is a connected person of our Company
“Hero Ace”	Hero Ace Limited, a company incorporated in the BVI with liability limited by shares on November 19, 2014, which is wholly-owned by Mr. Wong
“Hero Valour”	Hero Valour Limited, a company incorporated in the BVI with liability limited by shares on April 11, 2013, which is wholly-owned by Mr. Wong and is one of the Controlling Shareholders, and is a connected person of our Company

DEFINITIONS

“HKDD”	Dandy Don’s American Ice-Cream Factory Limited (丹迪噹美國雪糕廠有限公司), formerly known as Newtech Development & Trading Limited (新略發展貿易有限公司), a limited liability company incorporated in Hong Kong on September 10, 1992, a wholly-owned subsidiary of Elect Gold and beneficially owned by Mr. Wong as to 80% and by Super Active Profits Limited, an Independent Third Party, as to 20%, and is a connected person of our Company
“HK eIPO White Form”	the application for Hong Kong Offer Shares to be issued in the applicant’s own name by submitting applications online through the designated website of HK eIPO White Form at www.hkeipo.hk
“HK eIPO White Form Service Provider”	the HK eIPO White Form service provider designated by our Company as specified on the designated website at www.hkeipo.hk
“HKFRSs”	Hong Kong Accounting Standards, Hong Kong Financial Reporting Standards, amendments and the related interpretations issued by the Hong Kong Institute of Certified Public Accountants
“HKSCC”	Hong Kong Securities Clearing Company Limited, a wholly-owned subsidiary of Hong Kong Exchanges and Clearing Limited
“HKSCC Nominees”	HKSCC Nominees Limited, a wholly-owned subsidiary of HKSCC
“HK TWG Heritage”	TWG Heritage Tea Company Limited, a limited liability company incorporated in Hong Kong on December 7, 2012 and an indirect wholly-owned subsidiary of our Company
“Hong Kong” or “HK”	the Hong Kong Special Administrative Region of the PRC
“Hong Kong dollars” or “HK dollars” or “HK\$”	Hong Kong dollars, the lawful currency of Hong Kong
“Hong Kong Offer Share(s)”	the 23,920,000 new Shares initially offered by our Company for subscription pursuant to the Hong Kong Public Offering (which includes 2,392,000 Employee Reserved Shares being offered by our Company for subscription by Eligible Employees under the Employee Preferential Offering, subject to adjustments as described in the section headed “Structure of the Global Offering” in this prospectus)

DEFINITIONS

“Hong Kong Special Counsel”	Mr. Matthew L.C. Ho, barrister-at-law of Hong Kong
“Hong Kong Public Offering”	the offer of the Hong Kong Offer Shares for subscription by the public in Hong Kong (which includes the Employee Reserved Shares for subscription by the Eligible Employees, subject to adjustments as described in the section headed “Structure of the Global Offering” in this prospectus) for cash at the Offer Price (plus brokerage fee of 1%, SFC transaction levy of 0.0027% and Hong Kong Stock Exchange trading fee of 0.005%) and on the terms and subject to the conditions described in this prospectus and the Application Forms
“Hong Kong Share Registrar”	Tricor Investor Services Limited
“Hong Kong Stock Exchange”	The Stock Exchange of Hong Kong Limited
“Hong Kong Underwriters”	the underwriters of the Hong Kong Public Offering listed in the section headed “Underwriting — Hong Kong Underwriters” in this prospectus
“Hong Kong Underwriting Agreement”	the underwriting agreement dated April 26, 2018 relating to the Hong Kong Public Offering and entered into by, among others, our Company, our Controlling Shareholders, our executive Directors, the Joint Sponsors, the Sole Global Coordinator and the Hong Kong Underwriters as further described in the section headed “Underwriting — Underwriting Arrangements and Expenses — Hong Kong Public Offering” in this prospectus
“Independent Third Party(ies)”	an individual(s) or a company(ies) who or which is/are not connected (within the meaning of the Listing Rules) with any directors, chief executive or substantial shareholders of us, our subsidiaries or any of their respective associates
“International Offer Share(s)”	the 215,280,000 Shares (comprising 82,309,312 new Shares to be offered for subscription by our Company and 132,970,688 Sale Shares to be offered for sale by the Selling Shareholder) initially being offered for subscription at the Offer Price pursuant to the International Offering together with, where relevant, any additional Shares which may be issued by our Company pursuant to the exercise of the Over-allotment Option (subject to adjustments as described in the section headed “Structure of the Global Offering” in this prospectus)

DEFINITIONS

“International Offering”	the offer of the International Offer Shares at the Offer Price to professional, institutional, corporate and other investors in Hong Kong and other jurisdictions outside the United States in offshore transactions in accordance with Regulation S or any other available exemption for registration under the U.S. Securities Act, as further described in the section headed “Structure of the Global Offering” in this prospectus
“International Underwriters”	the group of international underwriters, led by the Sole Global Coordinator, that is expected to enter into the International Underwriting Agreement to underwrite the International Offering
“International Underwriting Agreement”	the international underwriting agreement expected to be entered into on or around May 4, 2018 by, among others, our Company, the Selling Shareholder, the Sole Global Coordinator, the Joint Bookrunners, the Joint Lead Managers, the Co-lead Managers and the International Underwriters in respect of the International Offering, as further described in the section headed “Underwriting — Underwriting Arrangements and Expenses — International Offering” in this prospectus
“Joint Bookrunners” and/or “Joint Lead Managers”	BOCI Asia Limited, DBS Asia Capital Limited, Kingsway Financial Services Group Limited, Future Land Resources Securities Limited, VBG Capital Limited
“JLL”	Jones Lang LaSalle Corporate Appraisal and Advisory Limited, an independent property valuer
“Joint Sponsors”	BOCI Asia Limited and BOSC International Company Limited
“Latest Practicable Date”	April 20, 2018, being the latest practicable date prior to the printing of this prospectus for the purpose of ascertaining certain information contained in this prospectus
“Listing”	the listing of the Shares on the Main Board of the Hong Kong Stock Exchange
“Listing Committee”	the Listing Committee of the Hong Kong Stock Exchange
“Listing Date”	the date, expected to be on or about May 11, 2018, on which the Shares are listed on the Hong Kong Stock Exchange and from which dealings in the Shares are permitted to commence on the Hong Kong Stock Exchange
“Listing Rules”	the Rules Governing the Listing of Securities on The Stock Exchange of Hong Kong Limited, as amended or supplemented from time to time

DEFINITIONS

“Macau”	the Macau Special Administrative Region of the PRC
“Memorandum” or “Memorandum of Association”	the memorandum of association of our Company, a summary of which is set out in Appendix III to this prospectus, and as altered from time to time
“MOF”	the Ministry of Finance of the PRC (中國財政部)
“MOFCOM”	the Ministry of Commerce of the PRC (中國商務部)
“MOP”	Macau Pataca, the lawful currency of Macau
“Mr. Wong”	Mr. Wong Tat Tong (黃達堂), the chairman of the Board, our executive Director and chief executive officer, and one of our Controlling Shareholders
“NDRC”	the National Development and Reform Commission of the PRC (中國國家發展和改革委員會)
“NH Foods”	NH Foods Limited, a limited liability company incorporated under the laws of Japan on May 30, 1949 whose shares are listed on the Tokyo Stock Exchange, Inc. (stock code: 2282)
“Offer Price”	the final price per Hong Kong Offer Share in Hong Kong dollars (exclusive of brokerage of 1%, SFC transaction levy of 0.0027% and Hong Kong Stock Exchange trading fee of 0.005%) of not more than HK\$2.19 and expected to be not less than HK\$1.50, at which Hong Kong Offer Shares are to be subscribed for pursuant to the Hong Kong Public Offering and to be determined as further described in the section headed “Structure of the Global Offering — Determining the Offer Price” in this prospectus
“Offer Share(s)”	the Share(s) offered in the Global Offering, where relevant, including any additional Shares issued by our Company pursuant to the exercise of the Over-allotment Option
“Oriole”	Oriole Food Company Limited (澳利高食品有限公司), a limited liability company incorporated in Hong Kong on November 13, 2002, which is wholly-owned by Mr. Chu Cho Wing, being the son of Mr. Chu Sun Chi, who is a shareholder and director of Whole Sun, and is a connected person of our Company

DEFINITIONS

“Oriole International”	Oriole Food International Limited (澳利高食品國際有限公司), a limited liability company incorporated in Hong Kong on March 22, 2017, which is owned as to 51% by Mr. Chu Cho Wing, being the son of Mr. Chu Sun Chi, who is a shareholder and director of Whole Sun and as to 49% by Ms. Li Sze Mun Charmaine, the daughter-in-law of Mr. Chu Sun Chi, and is a connected person of our Company
“Over-allotment Option”	the option expected to be granted by our Company to the Sole Global Coordinate (on behalf of the International Underwriters), exercisable by the Sole Global Coordinator (on behalf of the International Underwriters) pursuant to the International Underwriting Agreement, pursuant to which our Company may be required to allot and issue up to an aggregate of 35,880,000 additional Shares at the Offer Price to, among other things, cover over-allocations in the International Offering, if any, further details of which are described in the section headed “Structure of the Global Offering — The Over-allotment Option” in this prospectus
“ PINK Application Form(s)”	the application form(s) to be sent to Eligible Employees to subscribe for the Employee Reserved Shares pursuant to the Employee Preferential Offering
“PRC government” or “State”	the central government of the PRC, including all political subdivisions (including provincial, municipal and other regional or local government entities) and its organs or, as the context requires, any of them
“PRC Legal Advisers”	JunHe LLP
“Predecessor Companies Ordinance”	the predecessor Companies Ordinance (Chapter 32 of the Laws of Hong Kong) as in force before March 3, 2014
“Pre-IPO Share Option Scheme”	the pre-IPO share option scheme conditionally adopted by our Company on December 15, 2017, the principal terms of which are summarized in the paragraphs headed “D. Share Option Schemes — 1. Pre-IPO Share Option Scheme” in Appendix IV to this prospectus
“Price Determination Agreement”	the agreement to be entered into by the Sole Global Coordinator (for itself and on behalf of the Underwriters) and our Company (for ourselves and on behalf of the Selling Shareholder) on the Price Determination Date to record and fix the Offer Price

DEFINITIONS

“Price Determination Date”	the date, expected to be on or around Friday, May 4, 2018 (Hong Kong time) and, in any event no later than Monday, May 7, 2018 (Hong Kong time) on which the Offer Price is determined by agreement between our Company (for ourselves and on behalf of the Selling Shareholder) and the Sole Global Coordinator (for itself and on behalf of the Underwriters)
“Principal Share Registrar”	Estera Management (Bermuda) Limited
“Regulation S”	Regulation S under the U.S. Securities Act
“Reporting Accountants”	Ernst & Young
“RMB” or “Renminbi”	Renminbi, the lawful currency of the PRC
“S\$”	Singapore dollars, the lawful currency of the Republic of Singapore
“SAFE”	the State Administration of Foreign Exchange of the PRC (中國國家外匯管理局)
“SAIC”	the State Administration of Industry and Commerce of the PRC (中國國家工商行政管理總局)
“Sale Shares”	132,970,688 Shares to be offered for sale by the Selling Shareholder at the Offer Price under the Global Offering
“SAT”	the State Administration of Taxation of the PRC (中國國家稅務總局)
“Selling Shareholder”	Hero Valour Limited, being the Shareholder which offers the Sale Shares for sale under the Global Offering, particulars of which are set out in the section headed “E. Other Information — 11. Particulars of the Selling Shareholder” in Appendix IV to this prospectus
“SFC”	the Securities and Futures Commission of Hong Kong
“SFO”	the Securities and Futures Ordinance (Chapter 571 of the Laws of Hong Kong), as amended or supplemented from time to time
“SGX-ST”	Singapore Exchange Securities Trading Limited
“Share(s)”	ordinary share(s) in the capital of our Company following the Share Subdivision with a par value of HK\$0.10 each

DEFINITIONS

“Share Option Scheme”	the share option scheme conditionally approved and adopted by our Company on December 15, 2017, the principal terms of which are summarized in the paragraphs headed “D. Share Option Schemes — 2. Share Option Scheme” in Appendix IV to this prospectus
“Share Option Schemes”	the Pre-IPO Share Option Scheme and the Share Option Scheme
“Shareholder(s)”	holder(s) of Shares
“Share Subdivision”	the subdivision of every two issued and unissued ordinary shares of par value HK\$0.25 each of our Company into five ordinary shares of par value HK\$0.10 each effected on September 4, 2017, the details of which are described in “History, Development and Corporate Structure — Our Corporate Development — Our Company” in this prospectus
“SHTW”	Shanghai Tsit Wing Food Company Limited* (上海捷榮食品有限公司), a limited liability company established under the laws of the PRC on June 6, 2003 and an indirect wholly-owned subsidiary of our Company
“Sole Global Coordinator” or “Stabilizing Manager” or “Settlement Agent”	BOCI Asia Limited
“State Council”	the State Council of the PRC (中國國務院)
“Stock Borrowing Agreement”	the stock borrowing agreement expected to be entered into on or about the Price Determination Date between the Stabilizing Manager (or its affiliates acting on its behalf) and Hero Valour, pursuant to which Hero Valour will agree to lend up to 35,880,000 Shares to the Stabilizing Manager on terms set forth therein
“Takeovers Code”	Codes on Takeovers and Mergers and Share Buy-backs issued by the SFC, as amended or supplemented from time to time
“Telenice”	Telenice Company Limited, a limited liability company incorporated in Hong Kong on July 9, 1985, which is beneficially owned as to approximately 50% by Mr. Wong and as to approximately 50% by Ms. Li Ying Wah Irene, being the spouse of Mr. Wong, respectively, and is a connected person of our Company

DEFINITIONS

“Track Record Period”	the period comprising the three financial years of our Company ended December 31, 2015, 2016 and 2017
“TW Beverage Machine”	Tsit Wing Beverage Machine Company Limited (捷榮餐飲設備有限公司), formerly known as TW Café Limited (捷榮咖啡一族有限公司) and Alfardi Holdings Limited, a limited liability company incorporated in Hong Kong on October 5, 1993 and an indirect wholly-owned subsidiary of our Company
“TWCC”	Tsit Wing (China) Caterer Limited (捷榮(中國)餐飲有限公司), a limited liability company incorporated in Hong Kong on February 22, 2012 and an indirect wholly-owned subsidiary of our Company and is under the process of deregistration as of the Latest Practicable Date
“TWCE”	Tsit Wing (China) Enterprises Company Limited (捷榮(中國)企業有限公司), formerly known as TW (China) Cafe Limited (捷榮(中國)咖啡店有限公司), a limited liability company incorporated in Hong Kong on June 12, 2002 and an indirect wholly-owned subsidiary of our Company
“TWCH”	Tsit Wing (China) Holdings Limited (捷榮(中國)控股有限公司), a limited liability company incorporated in Hong Kong on February 9, 2011 and a direct wholly-owned subsidiary of our Company
“TWCI”	Tsit Wing (China) Industrial Company Limited (捷榮(中國)實業有限公司), formerly known as Tsit Wing (China) Investment Limited (捷榮(中國)投資有限公司), a limited liability company incorporated in Hong Kong on December 15, 1999 and an indirect wholly-owned subsidiary of our Company
“TWCT”	Tsit Wing (China) Trading Limited (捷榮(中國)貿易有限公司), a limited liability company incorporated in Hong Kong on February 22, 2012 and an indirect wholly-owned subsidiary of our Company
“TWFF”	Tsit Wing Frozen Food Company Limited (捷榮冷凍食品有限公司), formerly known as World Elegant Limited (寰采有限公司), a limited liability company incorporated in Hong Kong on August 10, 2012 and an indirect wholly-owned subsidiary of our Company and is under the process of deregistration as of the Latest Practicable Date

DEFINITIONS

“TWGM”	Tsit Wing Trademarks And Patent Company Limited (捷榮商標專利有限公司), formerly known as Tsit Wing Global Marks Holdings Limited and Tsit Wing Trading Company Limited, a company incorporated in the BVI with limited liability on December 21, 1993 and an indirect wholly-owned subsidiary of our Company
“TWHK”	Tsit Wing (Hong Kong) Company Limited (捷榮集團(香港)有限公司), formerly known as Tsit Wing Coffee Company, Limited (捷榮咖啡有限公司), a limited liability company incorporated in Hong Kong on January 3, 1956 and an indirect wholly-owned subsidiary of our Company
“TWHKFF”	Tsit Wing (Hong Kong) Frozen Food Company Limited (捷榮(香港)冷凍食品有限公司), formerly known as Tsit Wing (China) Co., Limited (捷榮(中國)有限公司), a limited liability company incorporated in Hong Kong on December 10, 1992 and an indirect wholly-owned subsidiary of our Company
“TWIC”	Tsit Wing International Company Limited, formerly known as Erno Development Limited, a company incorporated in the BVI with limited liability on December 23, 1991 and a direct wholly-owned subsidiary of our Company
“Underwriters”	the Hong Kong Underwriters and the International Underwriters
“Underwriting Agreements”	the Hong Kong Underwriting Agreement and the International Underwriting Agreement
“U.S.” or “United States”	the United States of America
“U.S. dollars” or “US\$”	U.S. dollars, the lawful currency of the United States
“U.S. Securities Act”	the U.S. Securities Act of 1933, as amended and supplemented or otherwise modified from time to time, and the rules and regulations promulgated thereunder
“WHITE Application Form(s)”	the application form(s) for use by the public who require(s) such Hong Kong Offer Shares to be issued in the applicant’s own name(s)
“Whole Sun”	Whole Sun Limited (浩新貿易有限公司), formerly known as Tsit Wing Frozen Food Trading Limited, a limited liability company incorporated in Hong Kong on January 7, 2013 and an indirect 60%-owned subsidiary of our Company

DEFINITIONS

“ YELLOW Application Form(s)”	the application form(s) for use by the public who require(s) such Hong Kong Offer Shares to be deposited directly into CCASS
“ZHTW”	Zhuhai Tsit Wing Food Co., Ltd.* (珠海捷榮食品有限公司), a limited liability company established under the laws of the PRC on May 4, 1994 and an indirect wholly-owned subsidiary of our Company prior to its deregistration on December 30, 2013

* *For identification purposes only*

In this prospectus, the terms “associate,” “close associate,” “connected person,” “connected transaction,” “controlling shareholder,” “core connected person,” “subsidiary” and “substantial shareholder” shall have the meanings given to such terms in the Listing Rules, unless the context otherwise requires.

Certain amounts and percentage figures included in this prospectus have been subject to rounding adjustments. Accordingly, figures shown as totals in certain tables may not be an arithmetic aggregation of the figures preceding them.

The English translation of the PRC entities, enterprises, nationals, facilities, regulations in Chinese or another language included in this prospectus is for identification purposes only. To the extent there is any inconsistency between the Chinese names of the PRC entities, enterprises, nationals, facilities, regulations and their English translations, the Chinese names shall prevail.

GLOSSARY OF TECHNICAL TERMS

This glossary contains explanations of certain terms used in this document. These terms and their meanings may or may not correspond to standard industry meaning or usage of these terms.

“B2B coffee and tea products market”	Generally B2B coffee and tea products market refers to the market in which producers sell their products to business customers, mainly food and beverage serving establishments (i.e. Cha Chann Teng, restaurant, hotel, fast food stores, leisure drink stores and cafe). At their own venues, food and beverage serving establishments would have a value-adding process such as making and serving coffee and tea drinks to consumers.
“CAGR”	compound annual growth rate, a method of assessing the average growth of a value over time
“FMCG”	Fast-moving consumer goods
“GDP”	Gross Domestic Product
“HACCP”	Hazard Analysis and Critical Control Point
“ISO”	an acronym for a series of quality management and quality assurance standards published by International Organisation for Standardisation, a non-government organisation based in Geneva, Switzerland, for assessing the quality systems of business organisations
“OEM”	original equipment manufacturer
“sq. feet”	square feet
“sq. meters”	square meters

FORWARD-LOOKING STATEMENTS

This prospectus contains certain forward-looking statements and information relating to our Company and our subsidiaries that are based on the beliefs of our management as well as assumptions made by and information currently available to our management. When used in this prospectus, the words “aim”, “anticipate”, “believe”, “could”, “consider”, “estimate”, “expect”, “going forward”, “intend”, “is/are likely to”, “may”, “ought to”, “plan”, “project”, “prospects”, “seek”, “should”, “will”, “would” and the negative of these words and other similar expressions, as they relate to our Group or our management, are intended to identify forward-looking statements. Such statements reflect the current views of our management with respect to future events, operations, liquidity and capital resources, some of which may not materialize or may change. These statements are subject to certain risks, uncertainties and assumptions, including the risk factors as described in the section headed “Risk Factors” in this prospectus. You are strongly cautioned that reliance on any forward-looking statements involves known and unknown risks and uncertainties. The risks and uncertainties facing our company which could affect the accuracy of forward-looking statements include, but are not limited to, the following:

- our business prospects;
- our future debt levels and capital needs;
- future developments, trends and conditions in the industry and markets in which we operate;
- our business strategies and plans to achieve these strategies;
- general economic, political and business conditions in the markets in which we operate;
- changes to the regulatory environment and general outlook in the industry and markets in which we operate;
- the effects of the global financial markets and economic crisis;
- our ability to reduce costs;
- our dividend policy;
- our capital expenditure plans;
- the amount and nature of, and potential for, future development of our business;
- capital market developments;
- the actions and developments of our competitors; and
- change or volatility in interest rates, foreign exchange rates, equity prices, volumes, operations, margins, risk management and overall market trends.

FORWARD-LOOKING STATEMENTS

Subject to the requirements of applicable laws, rules and regulations, we do not have any and undertake no obligation to update or otherwise revise the forward-looking statements in this prospectus, whether as a result of new information, future events or otherwise. As a result of these and other risks, uncertainties and assumptions, the forward-looking events and circumstances discussed in this prospectus might not occur in the way we expect or at all. Accordingly, you should not place undue reliance on any forward-looking statements and information.

In this prospectus, statements of or references to our intentions or those of our Directors are made as of the date of this prospectus. Any such information may change in light of future developments. All forward-looking statements and information contained in this prospectus are qualified by reference to the cautionary statements set out in this section.

RISK FACTORS

Potential investors should consider carefully all the information set out in this prospectus and, in particular, should evaluate the following risks associated with an investment in our Company before making any investment decision regarding our Company. Particular attention should be paid to the fact that our Company is incorporated in Bermuda and some of our Group's subsidiaries are located in the PRC and are governed by legal and regulatory environments which in some respects may differ from that in Hong Kong. Any of the risks and uncertainties described below could have a material and adverse effect on our business, financial position or on the trading price of the Shares, and could cause the loss of all or part of such investment.

This prospectus also contains "forward-looking statements" that involve risks and uncertainties. The actual results of our Group could differ materially from those anticipated in these forward-looking statements as a result of certain factors, including the risks faced by our Group as described in this prospectus. If any of the following considerations and uncertainties develops into actual events, our business, financial position or results of operations may be materially and adversely affected. In such circumstances, the trading price of the Shares could decline and may cause the loss of all or part of such investment.

RISKS RELATING TO OUR BUSINESS

Our business largely depends on the strength of our reputation and brand. If we fail to maintain or enhance our brand and reputation due to a failure to maintain effective quality control systems for our products, consumers' recognition of and trust in us and our products may be materially and adversely affected.

We believe that our food and beverage brand "Tsit Wing" or "TW" is well-recognized for quality and reliability among consumers, especially in the Hong Kong market. As one of the leading integrated B2B coffee and black tea solutions providers in Hong Kong, Macau and the PRC, we rely heavily on the strength of our brand and reputation when marketing our products and building our customer base. At the same time, our brand and reputation as well as the success of our business largely rests upon the quality and safety of our products. In turn, our product quality is contingent upon the effective implementation of our quality control systems, which depends on a number of factors, including the design of our quality control systems and our ability to ensure that our employees adhere to and implement those quality control policies and guidelines. For further details, please refer to the section headed "Business — Quality Management" in this prospectus. We cannot assure you that our quality control systems will continue to be effective or implemented according to our policies and guidelines. Any disruption to or failure to adhere to our quality control systems and/or procedures could materially and adversely affect the quality of our products, which could in turn, materially and adversely affect our reputation, business, financial condition and results of operations.

In addition, any incident that weakens customers' trust in our brand could significantly reduce our brand value. As we continue to grow in size, expand our food and beverage offering and extend our geographic reach, maintaining the quality and consistency of our products may become more challenging, and we cannot assure you that

RISK FACTORS

customers' confidence in our brand will not diminish. If our customers perceive or experience a drop in the quality of our products, service, efficiency, or deem that we are failing to deliver a consistently positive experience, our brand value could suffer, which could have material and adverse effect on our business, financial condition and results of operations.

We rely heavily on our suppliers for our raw materials.

During the Track Record Period, with the exception of ice-cream purchases from Elect Gold Group and purchases of raw materials from a supplier, which was our Former Shareholder between 2014 to 2016, we sourced all of our raw materials from suppliers which are Independent Third Parties, and we heavily relied on the performance of our suppliers for a sufficient and stable supply of raw materials. As of the Latest Practicable Date, we sourced a majority of our raw materials from suppliers which are Independent Third Parties. For the years ended December 31, 2015, 2016 and 2017, purchases from our five largest suppliers collectively accounted for approximately 44.3%, 43.2% and 44.3% of our total cost of sales during the same periods, respectively, and purchases from our largest supplier accounted for approximately 24.5%, 22.5% and 22.8% of our total cost of sales for the same periods, respectively.

Furthermore, in some instances, we rely on the global sourcing network of some of our major suppliers to source raw materials with particular specifications. These products may be particularly relevant to our production of customized products for relevant customers. The global sourcing network established by these suppliers allows them to source at competitive prices and provide us with a steady supply of raw materials that meet our requirements. If such key suppliers cease to supply raw materials to us, we may not be able to adapt in time to collaborate with alternative suppliers to meet our specific requirements. In turn, this can lead to an increase in our total cost of sales as alternative suppliers may not be able to provide raw materials at competitive prices or supply such raw materials in a timely manner.

In addition, there is no assurance that our raw material suppliers can always meet our demands for various reasons, such as fires, natural disasters, climate changes, manufacturing problems, disease, crop failure, strikes, transportation interruptions, government regulation, political instability or terrorism. A shortage or complete lack of supply could also occur due to suppliers' financial difficulties, including insolvency. In the event of a supply disruption, we may or may not be able to locate alternative suppliers to meet our demand in a timely manner or at prices acceptable to us. Furthermore, if all or a significant number of our suppliers for any particular raw materials are unable or unwilling to meet our requirements, we could suffer from material supply disruptions and/or face significant cost increases. Moreover, we may not be able to detect, deter and/or prevent all instances of fraud or other misconduct committed by our suppliers with respect to our supply orders. Continued supply disruptions would materially and adversely affect our operations, and we cannot assure you that all or part of any increased costs can be passed along to our customers in a timely manner or at all, which in turn, could materially and adversely affect our overall business, financial condition and results of operations.

RISK FACTORS

Increase in raw material prices could materially and adversely affect our business, financial condition and results of operations.

Our principal raw materials for the production of our products include coffee beans, processed tea leaves and milk, while the principal raw materials we procure for our food products business are frozen meat and frozen processed food. Our raw materials are subject to price fluctuation due to market and industry conditions, such as commodity price fluctuations, supply and demand changes and inflation. According to Frost & Sullivan, the average price of imported coffee green bean in Hong Kong decreased from HK\$12.4 per lb in 2012 to HK\$10.4 per lb in 2016, and the average price of imported tea from Sri Lanka in Hong Kong increased from HK\$13.2 per lb in 2012 to HK\$14.1 per lb in 2016. At the same time, our Company's average procurement price for coffee beans decreased from HK\$10.4 per lb for 2015 to HK\$9.2 per lb for 2016 and increased to HK\$10.3 per lb for 2017, and the average procurement price for processed tea leaves increased from HK\$11.7 per lb for 2015 to HK\$13.5 per lb for 2017. To manage the potential impact of price fluctuations on our purchases of coffee beans, we generally maintain one to three-month physical stock of coffee beans (subject to category of coffee bean) at any one time. In addition, we enter into forward supply contracts for coffee beans when necessary. For further details, please refer to the section headed "Business — Customers — Pricing — Raw Material Price Management" in this prospectus. However, we are unable to assure that we can successfully hedge against all price fluctuations with such measures, and commodity price increases may result in unexpected increases in our raw material costs in the future.

If our raw material prices are to increase and if we are not able to fully pass on the price increases to our customers, our results of operations, gross profit margins and profitability may be materially and adversely affected. Significant fluctuation in our raw material prices might also lead to reduced demand for our products if we pass on such price increases to our customers, which in turn, could materially and adversely affect our business, financial condition, and results of operations.

We do not typically enter into long-term arrangements with our customers, distributors and suppliers.

We generally do not enter into long-term arrangements with our customers, distributors and suppliers in order to retain flexibility in our operation. Our suppliers may reduce or cease to supply raw materials to us, and our customers and distributors may reduce or cease to purchase products from us at any time, which in turn, could materially and adversely affect our business, financial condition and results of operations. There is no assurance that we will be able to maintain long-term business relationships with our current suppliers, customers or distributors, including our major suppliers, distributors and customers. We cannot assure that future supply from our current suppliers or future sales to our current customers and distributors will not be disrupted.

Furthermore, there is no assurance that our current or future contracts, if any, with our major suppliers, customers and distributors can be negotiated on terms and prices equivalent to or more favorable than current terms and prices. Our sales and operating income could be materially and adversely affected if our suppliers', customers' or

RISK FACTORS

distributors' business plans or markets change materially or if we lose one or more of our major suppliers, customers or distributors. We may not be able to locate alternative suppliers, customers or distributors and the loss of major suppliers, customers or distributors, or adverse change to trade terms with such significant business partners, could materially and adversely affect our business, financial condition and results of operations.

We may not be able to receive compensation from suppliers for contaminated raw materials supplied to us and applied to our products, and indemnity provisions in our supply contracts may not be sufficient to cover our loss.

We rely on our suppliers to ensure the quality of our raw materials. For example, an essential part of our raw material quality control is to check on quality certifications and test reports accompanying our imported raw materials provided by our suppliers. If any raw material we source and apply to our production is contaminated, the quality of our products will be impaired, which in turn could materially and adversely affect our business, financial condition and results of operations.

Furthermore, if we become subject to food safety claims caused by contaminated or otherwise defective ingredients or raw materials from our suppliers, we may seek compensation from the relevant suppliers under the indemnity clauses of some of our supply contracts. However, indemnity provisions in our supply contracts may be insufficient to cover losses and/or consequential losses such as damaged reputation. During the Track Record Period, we received a one-time compensation of HK\$3.3 million from one of our suppliers regarding a spoilt milk product in 2015. Nevertheless, we cannot assure you that we can be successful in any and all claims against our suppliers in the future. If we are unable to assert a claim against a supplier or the amounts that we claim cannot be recovered from the supplier, to the extent that our insurance coverage is not sufficient to cover our loss, we may be required to bear such losses and liability on our own. In turn, such result could materially and adversely affect our business, financial condition and results of operations.

Our business is subject to changes in consumer preferences, perceptions and spending patterns.

Our business depends significantly on factors such as consumer income, preferences and tastes, spending patterns and perceptions of and confidence in our product safety and quality, as well as health awareness. Any change to the aforementioned factors could lead to an increase or decrease in demand for our products, and our future success will depend partly on our ability to anticipate, identify and/or adapt to such changes and to timely offer new products and/or advertising and promotion strategies to retain and attract new customers. In addition, consumer perceptions of our products may change due to factors including the marketing efforts of competitors and media reports regarding the taste, safety, quality or ingredients of our products as well as our competitors' products. We may from time to time fail to develop products and/or expand our product portfolio and marketing and pricing strategies that meet the trends or shifts in consumer preferences and tastes. Furthermore, we cannot assure you that we will be able to introduce new products that are in faster-growing and more profitable, or timely adjust our production of products in

RISK FACTORS

categories experiencing consumption declines. If we fail to develop products that are congruent with the trends or shifts in consumer preferences and tastes, our business, financial condition and results of operations may be adversely affected.

Our sales are geographically concentrated in Hong Kong and the PRC.

For the years ended December 31, 2015, 2016 and 2017, our sales originating from Hong Kong accounted for 73.1%, 74.0% and 73.0% of our total revenue for the respective periods, and our sales originating from the PRC constituted 24.6%, 24.0% and 25.1% of our total revenue for the respective periods. Going forward, we expect our sales in Hong Kong and the PRC to continue to account for a substantial portion of our revenue. Thus, our business, financial condition and results of operations are expected to continue to depend heavily on the general economic conditions and consumer preferences in these regions in the near future. In the event that there is any material adverse change in the economic and social conditions or sudden change in consumer preferences, perceptions and spending patterns in these regions, while we are unable to divert our sales to other markets in a timely manner, our business, financial condition and results of operations may be materially and adversely affected.

Our failure to attract and to retain key management and personnel could materially and adversely affect our ability to implement our business strategy.

We rely on the expertise and experience of our senior management team, who on average have over ten years of experience in the food and beverage services industry. There is no assurance that any or all of them will continue in his or her present capacity with us for any particular period of time, and the loss of services of any key management or personnel without appropriate replacement could have an adverse effect on our ability to implement our business strategy.

In addition, our success depends on our ability to attract and retain competent personnel. During the Track Record Period, we have employed coffee baristas and tea masters to help develop our customized products. However, there is no assurance that we can continue to attract and retain the relevant personnel required for such business development. We may also need to offer better remuneration and other benefits to recruit personnel that are critical to our operation and development, and we cannot assure you that we have the resources to fully achieve our staffing needs or are able to fulfill the personnel needs within a reasonable time frame. Our failure to attract and retain competent personnel, or any increase in staffing costs to retain such personnel might have a negative impact on our ability to maintain our competitive position and to grow our business.

RISK FACTORS

We rely on distributors which are Independent Third Parties to on-sell our products in Macau and the PRC and other overseas markets. Failure to maintain relationship with our existing distributors, attract new distributors or effectively manage our distributors may materially and adversely affect our business, financial condition and results of operations.

We sell a portion of our products to distributors which are Independent Third Parties in Macau, the PRC and other overseas markets. For the years ended December 31, 2015, 2016 and 2017, sales to our distributors accounted for approximately 7.2%, 7.5% and 8.3% of our total revenue for the same periods, respectively. Any reduction, delay or cancellation of orders from one or more of our distributors, inability to maintain relationship with our existing distributors or engage new and/or replacement distributors on favorable terms in a timely manner, may cause fluctuations or decline in our revenue and may have an adverse effect on our business, financial condition and results of operations.

We cannot assure you that our relationship with our distributors will continue to be stable, and we may lose some or all of our favorable arrangements with certain distributors. In addition, we have meetings with our distributors to get sales updates, but we do not manage their inventory directly, and hence any overstocking may affect our future sales. Furthermore, we may not be able to successfully manage our distributors and the cost of any consolidation or further expansion of our sales and distribution network may exceed the revenue generated from these efforts. There can be no assurance that we will be successful in detecting, deterring and preventing any non-compliance, fraud and/or other misconduct by our distributors with the relevant provisions of their distribution agreements. Non-compliance by our distributors may, among other things, negatively affect our brands, demand for our products and our relationship with other distributors. The occurrence of any of the aforementioned may result in a significant decrease in the sales volume of our products and in turn materially and adversely affect our business, financial condition and results of operations.

Any health or food safety problems or negative publicity and media reports related to our raw materials, our products, our operations or the general beverage and frozen meat and frozen processed food industry could materially and adversely affect our business, reputation and our ability to sell our products.

We are subject to risks affecting the food and beverage industry generally, including risks posed by (i) food and beverage contamination; (ii) contamination of raw materials; (iii) spoilage of raw materials; (iv) consumer product liability claims, customer complaints and/or litigation; (v) product tampering; (vi) product mishandling; (vii) product labeling errors; (viii) cost and unavailability of product liability insurance; (ix) cost and disruption of product recalls; and (x) health threats or other quality control concerns. For example, we cannot guarantee that contamination of our raw materials or products will not occur during the transportation, production, storage, distribution and sales processes due to reasons unknown to us or out of our control. Any product contamination caused in this regard could subject us to adverse publicity and government scrutiny, investigation or intervention and product returns or recalls, as well as product liability claims, resulting in extra costs while materially and adversely impacting our reputation, prospects and brand image.

RISK FACTORS

Moreover, negative media coverage regarding the quality, health issues, safety or nutritional value of our products or the general food and beverage industry could materially and adversely affect consumer recognition of and consumer confidence in us and our products. For example, in March 2017, the Brazilian police uncovered a massive meat adulteration scheme, and imports of frozen meat and poultry from Brazil were subsequently banned in both Hong Kong and the PRC due to concerns with the quality of the product. All chilled and frozen meat and poultry from the 21 processing plants under investigation by the Brazilian authorities were banned from import or sale in Hong Kong. There can be no assurance that same or similar incident will not occur in the future and if it occurs, it will not materially or adversely affect our reputation, business, financial condition and results of operations. In addition, our products and we may be the subject of negative news reports and allegations related to product quality and safety.

Any negative claim against us could divert our management's attention and other resources from our business development, which may materially and adversely affect our business, financial condition and results of operations. Furthermore, adverse publicity about regulatory or legal action against us could materially and adversely affect our customers' and end-consumers' confidence in us and our products, damage our reputation and brand image and reduce demand for our products, even if the regulatory or legal action is unfounded or immaterial to our operations.

We outsource the production of some of our products to OEM contractors. Any disruption in the supply of our products could have a material and adverse effect on our business, financial condition and results of operations.

We outsource the manufacturing of some of our products to OEM contractors. Our OEM contractors may decide not to accept our future purchase orders on the same or similar terms or at all. If an OEM contractor decides to substantially reduce its supply to us, substantially increase the prices of its products or terminate its business relationship with us, we may need to find a proper replacement in a timely manner, the failure of which may result in delays or defaults on our agreements with our customers and distributors. In addition, if any of our OEM contractors fails to provide the required amount of products meeting our quality standards, we may need to source products from other OEM contractors, which may result in additional costs and delays in the delivery of our products to our customers and distributors. If the products failing to meet our quality standards have already been sold to our customers and distributors, we may need to recall these products, resulting in additional costs, and our reputation may be negatively affected.

A number of factors could also cause prolonged interruptions or have a negative effect on the operations of these OEM contractors, such as equipment failures or property damages experienced by these OEM contractors, changes in laws and regulations that affect their manufacturing costs or process or financial difficulties or labor disputes faced by these OEM contractors. Moreover, we may not be able to exercise adequate control over the operations of our OEM contractors and as a result are not able to ensure their compliance with applicable laws and regulations. Failure on the part of any of our outsourced OEM contractors to comply with applicable laws and regulations, such as product, labor and environmental related laws and regulations, may result in negative publicity which may

RISK FACTORS

damage our image and reputation and materially and adversely affect our business and profitability. Any of the above events may also materially and adversely damage our relationships with our customers and distributors or disrupt the supply of our products, causing a material and adverse effect on our business, financial condition and results of operations.

We rely on third party logistics service providers to deliver some of our products, and our sales and reputation may be materially and adversely affected by delays in delivery or poor handling by such third party logistics service providers.

We have our own logistics team that delivers our products directly to our customers. To augment the delivery needs relating to the demand for our products and save costs for building our own distribution network in distant markets, we also rely on third party logistics service providers to deliver some of our products to our customers. For further details, please refer to the section headed “Business — Delivery and Logistics” in this prospectus. We have limited control over these logistics service providers, and the services provided by them may be interrupted as a result of weather conditions, labor shortages, contract disputes, road maintenance disruptions and other factors. If there is any interruption in their services, we may not be able to distribute our products in a timely manner, which in turn could result in a breach of our sales agreements with our customers/distributors. A delay in delivery could also have an adverse impact on the quality of our products and thus materially and adversely affect our brand and reputation or require us to contract with alternative logistics service providers at potentially higher costs.

Furthermore, we demand our logistics service providers to deliver our products in a quality-ensured environment with prescribed sanitation standards. In particular, we engage logistics service providers with dependable cold-chain transportation and storage capacity for our frozen meat products. As we only have limited control over our logistics service providers, there is no assurance over the quality of their services, in particular the quality of their vehicles or warehouses. If third party logistics service providers cause any damage to or loss of our products, our reputation, business, financial condition and results of operations may be materially and adversely affected.

There can also be no guarantee that we can continue or renew relationships with our existing logistics service providers on terms acceptable to us, or that we will be able to establish relationships with new logistics service providers to ensure accurate, timely and cost-effective delivery services. If we are unable to maintain or develop relationships with relevant third party logistics service providers, it may inhibit our ability to offer products in sufficient quantities, on a timely basis or at prices acceptable to our customers. Any disruption to our relationship with existing or new logistics service providers could interrupt our business operations, which in turn could materially and adversely affect our business, financial condition and results of operations.

RISK FACTORS

Our business operation may be materially and adversely affected if we fail to rent warehouses in Hong Kong at reasonable cost or at all.

As of the Latest Practicable Date, we leased 17 warehouses in Hong Kong including five temperature-controlled warehouses for our frozen meat and frozen processed food products. The lease agreements we entered into are for a fixed duration subject to renewal. It is possible that we may not secure the renewal of such lease agreements upon their respective expiry. Moreover, we believe that warehouse resources in Hong Kong is in high demand since cargos to the PRC that experience difficulties in custom clearance may choose warehouses in Hong Kong as a temporary hub for storage. Thus, potential shortage of warehouse supply, especially temperature-controlled warehouses, is likely to occur.

There can be no guarantee that we can renew the leases of our rented warehouses in Hong Kong. We may not be able to find suitable locations to relocate our raw materials or finished products, especially our frozen meat and frozen processed food products, in a timely manner and on commercially acceptable terms, or at all, which could result in temporary disruption to our operation.

If we fail to effectively manage our inventories or estimate accurately the demand for our products, we may face significant excess inventories which may materially and adversely affect our business, financial condition and results of operations.

As of December 31, 2015, 2016 and 2017, our inventories amounted to HK\$163.7 million, HK\$147.2 million and HK\$195.4 million, respectively. We cannot assure you that we will not experience any slow movement of inventories, which may result from our reduced sales due to change in consumer preference, change of marketing strategy by our major customers or incorrect estimation of the market demand for our products. As such, if we fail to manage our inventories effectively or are unable to dispose of excess inventories, we may face a risk of inventory obsolescence and/or significant inventory write-downs, which may impose pressure on our operating cash flow, and materially and adversely affect our business, financial condition and results of operations.

Sales of some of our products are subject to seasonality and fluctuations.

The sales of some of our products are subject to seasonality and fluctuations. Historically, we have experienced higher sales of our products such as frozen meat and beverages in the first and fourth quarters of each calendar year where there are holiday seasons such as Chinese New Year and Christmas. Sales can also fluctuate during the course of a calendar year for other reasons such as the launch of new products or advertising campaigns. Consequently, sales and operating results for any particular period will not necessarily be indicative of our results for the full year or future periods.

RISK FACTORS

We may not be able to protect our intellectual property rights and industrial know-how, and our ability to compete could be harmed if our intellectual property rights are infringed by or our industrial know-how is disclosed to third parties without our authorization.

We have developed trademarks, industrial know-how, product formula, production processes, technologies and other intellectual property rights that are of significant value to us. As of the Latest Practicable Date, we held 47 registered trademarks in Hong Kong and 91 in the PRC, which were material to our business. Further, we had 7 pending trademark applications and 3 trademark renewal applications in the PRC as of the Latest Practicable Date. Our products are marketed under our trademarks and brand names, which are critical to our continued success and growth, including, in particular, our brand “Tsit Wing” or “TW”. We cannot assure you that we will be able to detect the presence of counterfeited products in the market in a timely manner. Occurrence of counterfeiting or imitations could impact our reputation and brand, which may lead to loss of consumer confidence, reduced sales or higher costs for detection and prosecution. Furthermore, there can be no guarantee that any of our intellectual property rights will not be challenged, misappropriated or circumvented by third parties.

We rely on trade secrets to protect and secure our know-how in product formulas and production processes. We utilize a combination of contractual responsibilities and confidentiality restrictions in our agreements with our employees to prevent the leakage of our trade secrets, and legal and statutory protections to safeguard our proprietary rights, including the ingredients and product formulas. Any breach of confidentiality by our employees having access to our product formulas and other trade secrets could result in third parties, including our competitors, gaining access to such formulas and trade secrets. If our competitors are able to substantially copy our product formulas and/or our product packaging and manage to provide comparable products at competitive prices, our market share may decrease.

If the measures we have taken and the protection provided by law do not adequately safeguard our intellectual property rights and industrial know-how, we could suffer losses because of the sales of competing products, which exploit our intellectual property rights and industrial know-how. We also cannot assure you that we will succeed in future disputes, claims or litigation involving our intellectual property rights or third party intellectual property rights. Any of these developments could disrupt our business, divert our resources and management’s attention from our operations and materially and adversely affect our business, financial condition and results of operations.

RISK FACTORS

Claims from third parties for possible infringement of their intellectual property rights could materially and adversely affect our business, financial conditions and results of operations.

We may face claims of infringement of third parties' intellectual property rights and claims for indemnification resulting from such infringement. Third parties, including our competitors, may claim that one or more of our products infringe their intellectual property rights. In addition, we may be unaware of intellectual property registrations or applications relating to our products or business operations that may give rise to potential infringement claims against us. There may also be technologies relied on by us that are subject to infringement or other corresponding allegations or claims by third parties.

Parties making infringement claims may obtain an injunction to prevent us from delivering our products or using relevant technology. Intellectual property litigation is expensive and time-consuming and could divert management's attention from our day-to-day operation. A successful infringement claim against us could, among other things, require us to pay substantial damages, and cease manufacturing, selling or using products that have infringed a third party's intellectual property rights. Any intellectual property claim or litigation, regardless of the ultimate result, could damage our reputation and have a material and adverse effect on our business, financial condition and results of operations.

Our operations could be disrupted by failures or security breaches of our information technology systems.

We have installed information technology systems including SAP, QlikView and the Gideon System which form our ERP system to monitor our production process, increase the efficiency of our facilities and inventory management, and manage and analyze our operations and financial information, with details set out in the section headed "Business — Business Intelligence and Information Technology" in this prospectus. However, our information technology systems could be vulnerable to various threats including without limitation intentional alteration of data, acts of nature, system configuration error, unauthorized disclosure of information, cyber-attacks, electrical disruption and telecommunication malfunction. Our protection schemes for our information technology systems may not be sufficient and any serious system failure or system malfunction could negatively impact our operations. Moreover, any unauthorized disclosure of information could cause a leak of trade secrets, confidential information and/or customer information, which could materially and adversely affect our reputation, business, financial condition and results of operations.

We are subject to the credit risk of our customers.

Our profitability is affected by the risk of our customers defaulting on the amounts that they owe to us. From time to time, in the ordinary course of our business, certain customers may default on their payment to us. Such defaults in payments to us would materially and adversely affect our financial condition, results of operations and profitability. Our provisions for bad and doubtful trade receivables were HK\$2.9 million, HK\$0.7 million and HK\$1.2 million for the years ended December 31, 2015, 2016 and 2017,

RISK FACTORS

respectively. Default risk may nevertheless arise from events or circumstances that are difficult to anticipate or detect. Any increase in credit risk of our customers could materially and adversely affect our business, financial condition and results of operations.

Litigation or legal proceedings could expose us to liability, divert our management’s attention and negatively impact our reputation.

We may be involved in litigation or legal proceedings during the ordinary course of business in relation to, among other things, product or other types of liability, labor disputes or contract disputes that could have a material and adverse effect on our business, financial condition and results of operations. For instance, we initiated a claim against TWG Tea Co Pte Ltd and The Wellbeing Group (HK) Company Limited for infringement of our registered trademarks and passing off of our trademarks in Hong Kong that commenced in 2011 and concluded in 2016. Please refer to “Business — Legal Proceedings and Compliance — Legal Proceedings — Litigation in relation to trademark infringement” in this prospectus for further details. These actions could also expose us to negative publicity, which might materially and adversely affect our brand, reputation and consumer confidence in us and our products. If we become involved in any litigation or legal proceedings in the future, the outcome of these types of proceedings could be uncertain and may result in settlements or outcomes that materially and adversely affect our financial condition and results of operations. In addition, any litigation or legal proceedings could lead us to incurring substantial legal expenses as well as require significant time and attention of our management and key personnel. Such development could divert the attention of our management and key personnel, which in turn, could materially and adversely affect our business, financial condition and results of operations.

Compensation from settled trademark litigation is a non-recurring income which may affect our future financial conditions and results of operations.

In 2011, we initiated a claim against TWG Tea Co Pte Ltd and The Wellbeing Group (HK) Company Limited for infringement of our registered trademarks and passing off of our trademarks in Hong Kong. The claim concluded in favour of our Group in 2016. For further details, please refer to the section headed “Business — Legal Proceedings and Compliance — Legal Proceedings — Litigation in relation to trademark infringement” in this prospectus.

As a result, we received compensation in an aggregate amount of approximately HK\$26.0 million, which was recognized as other income and gains, net, in the amounts of approximately HK\$10.0 million and HK\$16.0 million for the years ended December 31, 2015 and 2016, respectively. For further details, please refer to the section headed “Financial Information — Description of Certain Components of Consolidated Statements of Profit or Loss and Other Comprehensive Income — Other income and gains, net” in this prospectus.

RISK FACTORS

Receiving compensation from the settled trademark litigation is a one-time, non-recurring income. The full and final settlement for the trademark litigation was received by our Group during the year ended December 31, 2016. However, we cannot assure you that we would receive compensation of the same or similar nature in the future, which may affect our future financial conditions and results of operations.

Any operational failure or disruption at our production facilities could negatively affect our business.

We produce all of our roasted coffee and blended tea products at our own production facilities. Any disruption to, or shortage of, water, electricity or gas may materially and adversely affect our production output. Our reliance on public utilities providers will further increase as we expand our production capacity. A significant disruption to, or shortage of, utilities may prevent us from manufacturing sufficient products during the affected period and may materially and adversely affect our business, financial condition and results of operations. Our ability to adequately preserve our inventory of raw materials and to produce, distribute and sell our products is also critical to our success. If all or a portion of the raw materials we hold in inventory is damaged, our ability to produce, distribute or sell our products could be partially or materially hindered. In addition, we may experience difficulties and delays inherent in the production and sale of our products due to a variety of factors, including:

- accidents resulting in a temporary suspension of our production facilities;
- failure to obtain or protect or loss of our patents or any limitations imposed on our use of the same;
- our failure, or the failure of any of our suppliers, to comply with applicable laws and regulations and quality assurance guidelines that could lead to temporary product seizure or recalls, production shutdowns, production delays and product shortages; and/or
- other production or distribution problems, including limitations to manufacturing capability due to the imposition of new regulatory requirements on the type, size and weight of the products.

Our failure to take adequate steps to mitigate the likelihood or potential impact of such events, or to effectively manage such events if they occur, could materially and adversely affect our business, financial condition and results of operations.

Our efforts in introducing and promoting new products may not be successful.

The food and beverage industry in Hong Kong and the PRC is highly competitive and susceptible to fast-changing consumer tastes and preferences. Consumers' preferences often shift when new products are launched or introduced by various marketing and pricing campaigns of different brands. In light of the highly competitive environment, our future growth depends on our ability to continue to successfully introduce new products, flavors and packaging. Developing and introducing new products can be expensive and the return

RISK FACTORS

can be uncertain, and our new products or flavors may not be able to gain market acceptance or meet the particular tastes or preferences of consumers. We cannot assure you that the sales of new products we introduce and promote will be fast-growing and/or can generate acceptable operating margins. Our market share and financial performance would be negatively affected if we are unable to execute our strategy of continuously introducing new products, improving our product offering and satisfying changing customers' preferences and tastes.

Our marketing and promotion expenses amounted to approximately HK\$14.7 million, HK\$17.1 million and HK\$18.3 million for the years ended December 31, 2015, 2016 and 2017, respectively. Increase in competition may cause our competitors to substantially increase their advertising expenditures and promotional activities or to engage in market disrupting pricing behavior. At the same time, an increase in competition could require us to continue to increase our promotion and advertising expenditures, which may materially and adversely affect our margins and profitability. Nevertheless, we cannot guarantee you that our marketing efforts will be sufficient to compete with our competitors, and any reduction in our market share as a result of such competition could have an adverse impact on our business, financial condition and results of operations.

Substantial investment and upgrading may be required for our facilities and operations as we continue to develop new products and optimize production processes, and there can be no assurance that such investment would yield the intended results.

We are dedicated to maintaining an optimized production process. We strive to continue to adopt new production technologies to enhance our existing production capabilities and processes. Substantial investment and upgrading may be required for our facilities and operations in order to implement our research results or to expand our production capability or optimize our existing production capability. For example, our key machines for processing our coffee and tea products in our production facility in Hong Kong have on average been in use for over ten years, and we may incur significant costs in upgrading our machines and equipment to increase productivity. If the upgrading costs exceed the anticipated costs or the upgrade does not lead to increase in revenue as anticipated, our business, financial condition and results of operations could be materially and adversely affected.

In addition, as we continuously strive to expand our business scope and enter into new business areas, we need to be equipped with relevant facilities for production. For example, we entered into the frozen meat trading business in 2013 and we are planning to further vertically expand our business into frozen meat processing business. As a result, we intend to build a frozen meat processing line. We cannot assure you that our investment would yield the intended results, and any failure to develop as planned could materially and adversely affect our business, financial condition and results of operations.

RISK FACTORS

Certain defects in land use rights and the lack of relevant permits and certificates with respect to the properties occupied by us may adversely affect our ability to use such properties and in turn, our business operation.

Since September 6, 2010 when we obtained the land use rights for a parcel of land in Dongguan, the PRC with a site area of 31,999.05 sq. meters (the “**Dongguan Plant Land**”), we did not have the real estate ownership certificate for two of our warehouses on the Dongguan Plant Land. We also have not completed filing of the requisite construction completion reports and archives to the authorities. On December 15, 2017, we obtained a temporary construction permit for a period of two years for one of these two warehouses. If we cannot obtain a temporary construction permit for the other warehouse on the Dongguan Plant Land, or if such permit granted or will be granted subsequently expired, we may be requested to demolish the warehouses and be imposed with a fine of up to RMB1,321,000. For further details, please refer to the section headed “Business — Legal Proceedings and Compliance — Non-compliance Matters — Incident 2” in this prospectus.

We have applied to relevant authorities to change the nature of the land use rights of a parcel of land in Dongguan, the PRC, with an area of approximately 7,153.3 sq. meters, with the buildings erected on the land that have an aggregate gross floor area of approximately 5,388.7 sq. meters (the “**Dongguan Dormitory Land**”) from collective-owned land to state-owned land through expropriation. We intend to obtain the land use rights of such land by means of the tender invitation, auction or listing procedure or any other relevant application procedures as determined by the relevant authorities from time to time (the “**Land Grant Process**”). Based on the interviews with Dongguan Hengli Industrial Co., Ltd. (東莞橫瀝實業有限公司) on July 25, 2017 and with the Investment Office of Dongguan Hengli People’s Government (東莞市橫瀝鎮人民政府投資辦公室) on August 24, 2017, we obtained confirmation to continue usage of the said Dongguan Dormitory Land and the buildings on such land pending completion of the Land Grant Process. However, as such procedures are open to public and involving other third party participants, we cannot determine or assess the chance for which we will succeed, or assure you that we will succeed in such procedures. For further details, please refer to the section headed “Business — Legal Proceedings and Compliance — Non-compliance Matters — Incident 1” in this prospectus. If we cannot obtain the relevant land use rights, permits or certificates in a timely manner and our legal rights to use or occupy the relevant land and buildings are challenged, our business operation may be adversely affected.

Our performance relies on stable labor relations with our employees, and any deterioration in labor relations, shortage of labor or material increase in staff costs may adversely affect our business, financial condition and results of operations.

We consider stable labor relations as key to maintaining our business performance and operating results. In this regard, any deterioration of our labor relations could cause labor disputes, resulting in the disruption of our production and business operations. Labor costs in the PRC have significantly increased as a result of the PRC’s rapid economic growth since its reform and opening up in the late 1970s. Average wage in the PRC is expected to experience continual increases. Our operations in Hong Kong are required to comply with the statutory minimum wage requirements, which came into force on May 1, 2011. With

RISK FACTORS

effect from May 1, 2017, the statutory minimum wage rate in Hong Kong is raised from HK\$32.5 per hour to HK\$34.5 per hour. Our staff costs have increased as a result of the increase of the statutory minimum wage rate in Hong Kong. Increased statutory minimum wage rate may increase competition for qualified employees, which may indirectly result in further increase in the salaries of our employees. We may not be able to increase our prices to pass such increased staff costs onto our customers, in which case our business, financial condition and results of operations would be materially and adversely affected.

We may also need to increase our total compensation packages to attract and retain key personnel who are essential to our business development. Any material shortage in availability in labor or increase in our labor costs resulting from factors including the aforementioned may have an adverse effect on our business, financial condition and results of operations.

Our employees are subject to risks of serious injury caused by the use of logistics, production equipment and machinery.

We apply heavy machinery and equipment such as crane, forklift, grinding, packing and sieve cleaning equipment during our logistics and production process. The application of such machinery and equipment is potentially dangerous and may cause accidents and personal injury to our employees. Any accident caused by the use of such equipment or machinery could interrupt our production and result in legal and regulatory liabilities. During the Track Record Period, we had immaterial work-related injuries claims and the total compensation we paid for these claims was approximately HK\$747,513, which were or would be entirely covered by our employees compensation insurance. For further details, please refer to the section headed “Business — Health, Work Safety, Social and Environmental Matters” in this prospectus. Insurance coverage related to accidents resulting from the use of our equipment or machinery may be inadequate to offset losses arising from claims related to such accidents. In addition, we cannot assure you that similar accidents will not happen in the future. Moreover, potential industrial accidents that result in material property loss or personal injury may subject us to claims and lawsuits, and we may be liable for medical expenses and other payments to the employees and their families as well as fines or penalties. In turn, our reputation, brand, business, financial condition and results of operations may be materially and adversely affected as a result of such incidents.

Improvements to our risk management and internal control systems may not be adequate or effective.

We have designed and implemented risk management and internal control systems comprising relevant organizational framework policies and procedures, financial reporting procedures and processes, compliance rules and policies and risk management measures that we believe are appropriate for our business operations. However, there can be no guarantee that our risk management and internal control systems will be sufficiently effective in ensuring, among other things, the accurate reporting of financial results and preventing instances of fraud. Since our risk management and internal control systems depend on implementation by our employees, we cannot assure you that our employees are

RISK FACTORS

sufficiently trained to implement the systems or that their implementation will not involve any human error or mistake. In addition, we may not be able to detect, deter and/or prevent all instances of fraud or other misconduct committed by our employees or any other third parties. If we fail to timely update, implement and modify or fail to deploy sufficient human resources on, as applicable, our internal control and risk management policies and procedures, our business, financial condition and results of operations could be materially and adversely affected.

We may require additional funding to finance our operations, which may not be available on terms acceptable to us or at all. In addition, our level of indebtedness and the terms of our indebtedness could materially and adversely affect our business and liquidity position.

We generally fund our operations primarily with proceeds from the sale of products and bank and other borrowings. As of February 28, 2018, being the latest practicable date for determining our indebtedness, we had outstanding indebtedness (including bank borrowings and loans) of HK\$201.8 million and unutilized credit facilities of HK\$120.0 million from commercial banks. For further details regarding our borrowings, please refer to the section headed “Financial Information — Indebtedness” in this prospectus. To finance our ongoing operations, existing and future capital expenditure requirements, acquisition and investment plans and other funding requirements, we may need to obtain financing from external sources to supplement our internal sources of liquidity. Our ability to obtain external financing is subject to a variety of uncertainties, including:

- our future financial condition, results of operations and cash flows;
- general market conditions for capital raising and debt financing activities; and
- economic, political and other conditions in Hong Kong and elsewhere.

If we fail to renew our existing bank borrowings or raise additional funding through future debt or equity offerings as needed, our ability to implement our business strategy may be impaired, which could materially and adversely affect our growth, business, financial condition and results of operations. In addition, our ability to comply with financial covenants and conditions, make scheduled payments of principal and interest accrued thereon or refinance existing borrowings depends on our business performance, which is subject to economic, financial, competitive and other factors, including the other risks described in this prospectus.

Any future bank borrowings or other debt financing that we obtain may contain covenants that may, among other things, restrict our ability to pay dividends, obtain additional financing, create liens and encumbrances, merge, dissolve, liquidate or consolidate, and dispose of or transfer assets and may result in higher leverage and finance costs. Servicing these types of debt obligations and complying with their covenants could be burdensome to our operations. If we fail to service such debt obligations or are unable to comply with any of their covenants, we could be in default under such debt obligations, and our liquidity and financial condition could be materially and adversely affected.

RISK FACTORS

We may not be able to manage our rapid growth effectively and/or implement our future expansion plans on time, within budget or at all, or we may fail to realize the anticipated benefits from our expansion plans.

As a leading integrated B2B coffee and black tea solutions provider in Hong Kong, Macau and the PRC, we seek to continue to diversify the products we offer and expand our sales volume, and our business prospects depend on our ability to continually expand our production capacity to better meet the demand of our customers. We are currently planning to, among other things, develop our food business to expand our product portfolio and expand our food and beverage business in Southeast Asia. Details of our future expansion plans are set forth in the section headed “Future Plans and Use of Proceeds” in this prospectus. Our future expansion plans are subject to significant business, economic and competitive risks and uncertainties, many of which are beyond our control. Such risks and uncertainties may include:

- delays in the delivery and installation of our production equipment;
- operational difficulties resulting from technology challenges, and our lack of experience in new target markets;
- labor shortages;
- any failure to comply with new laws and regulations;
- food and product safety issues; and
- delays or failures in securing the necessary governmental approvals and permits, including land use rights.

Furthermore, managing our expansion plans could impose substantial demands on our managerial, operational and financial resources and increase our working capital needs. It will be time-consuming and may distract our management from focusing on our existing operations, which may materially and adversely affect our ability to satisfy customer demand and maintain product quality. We cannot assure you that our management and personnel, systems, procedures and controls will be adequate to support our future expansion plans or manage rapid growth effectively. These plans may or may not be implemented on time, within budget or at all, and may not result in the anticipated benefits even if implemented. If we fail to successfully manage our expansion plans and/or other risks related to our expansion plans, our business, financial condition and results of operations could be materially and adversely affected.

We have recognized some goodwill. If such goodwill is to be impaired, it would materially and adversely affect our financial condition and results of operations.

We recognized goodwill in the amounts of approximately HK\$15.4 million, HK\$15.4 million and HK\$15.4 million as of each of the dates of December 31, 2015, 2016 and 2017, respectively, accounting for approximately 2.7%, 2.6% and 2.7% of our total assets as of the same respective dates. The goodwill we recognized arose from our acquisition of the

RISK FACTORS

frozen meat business in Hong Kong in 2013 and the manufacturing and wholesale of the ice-cream business in the PRC in 2014. We review goodwill for impairment at least annually or more frequently if events or changes in circumstances indicate potential impairment. Determining whether goodwill is impaired requires us to estimate the value in use of the cash-generating unit to which we have allocated goodwill. This value-in-use calculation requires us to estimate the future cash flows expected to arise from the cash-generating unit and a suitable discount rate in order to calculate the present value. Where the carrying amount exceeds the estimated recoverable amount, an impairment loss may arise. We recognized approximately HK\$4.9 million impairment losses in respect of goodwill in the year ended December 31, 2015, as a result of keen competition in ice-cream products in the PRC market. The Group subsequently disposed of its ice-cream business in 2016. For further details, please refer to Note 16 of the Accountants' Report as set out in Appendix I to this prospectus.

In evaluating the potential for impairment of goodwill, we make assumptions regarding the continuity of the frozen food products business, its future operating performance, its business trends and market and economic conditions. This analysis requires us to make subjective assumptions, and there are inherent uncertainties relating to this analysis and our management's judgment in assessing the recoverability of the goodwill. Our estimates of the projected cash flows from the relevant cash-generating unit related to the frozen products business may be susceptible to downward revision as a result of factors that materially and adversely affect our frozen products business, or under circumstances where the frozen products business fails to sustain the growth we have estimated for it. If we were required to recognize impairment charges, they could substantially affect our reported earnings in the periods when recognized. In addition, impairment charges would negatively affect our financial ratios and could limit our ability to obtain future financing, which in turn, could materially and adversely affect our business, financial condition and results of operations.

Our insurance coverage may not be adequate to cover all the risks.

We have maintained insurance coverage in line with industry practices in Hong Kong, including medical, compensation, life, and travel insurance for our employees, as well as product liability, business interruption and commercial general liability. For further details regarding our insurance coverage, please refer to the section headed "Business — Insurance" in this prospectus. There are also certain types of losses, such as those resulting from wars, acts of terrorism, or natural disasters, for which we cannot obtain insurance at a reasonable cost or at all. If we are exposed to the liabilities in respect of any of the uninsured risks, or if we do not have adequate insurance coverage, our prospects, business, financial condition and results of operations could be materially and adversely affected.

RISK FACTORS

We may undertake acquisitions, investments, joint ventures or other strategic alliances. We may not be successful in these undertakings, which could materially and adversely affect our ability to manage our business.

We expanded our product portfolio by adding frozen meat through the acquisition by Whole Sun of the business and assets of a frozen meat supplier in Hong Kong in 2013. For further details, please refer to the section headed “History, Development and Corporate Structure — Our Corporate Development — (a) Major subsidiaries of TWIC — Whole Sun” in this prospectus. Going forward, we may undertake acquisitions, investments, joint ventures or other strategic alliances as part of our strategy to further grow our business. However, such undertakings may not be successful. We may not be able to identify suitable future acquisition targets or alliance partners that suit our expansion needs. Even when we are able to identify such suitable targets or partners, we may be unable to complete an acquisition or alliance on terms commercially acceptable to us. If we fail to identify appropriate targets or partners, complete desired acquisitions or alliances, or successfully address the risks associated with such acquisitions, investments or strategic alliances, we may not be able to achieve expansion effectively or efficiently.

In addition, our ability to successfully integrate acquired companies may be materially and adversely affected by a number of factors. These factors include diversion of management’s attention, difficulties in retaining personnel of the acquired companies, unanticipated legal liabilities, and tax and accounting issues in association with the acquisition and business combination. If we fail to integrate acquired companies efficiently, our business, financial condition and results of operations could be materially and adversely affected. Furthermore, the acquired companies may not perform to our expectations for various reasons, including legislative or regulatory changes that affect the products in which the acquired companies specialize and the loss of key personnel. If we are not able to realize the benefits envisioned for such acquisitions, our business, financial condition and results of operations could be materially and adversely affected.

RISKS RELATING TO OUR INDUSTRY

We operate in a highly competitive industry and may face increased competition in the future.

The fast-moving consumer goods market is highly competitive as there are few barriers to entry and the industry has a number of well-established companies with more recognizable and widely accepted brands. The preferences of consumers are subject to rapid and unanticipated changes. Some of our competitors may have been in their respective businesses longer than we have and thus they may have comparatively better financial, personnel, research and development and other resources than us. There is also no assurance that our current or potential competitors will not market products comparable or superior to those we produce or will adapt more promptly to evolving market trends or changing industry requirements than we do. It is also possible that there will be consolidation in the fast-moving consumer goods industry, and even integration of upstream and downstream businesses or alliances among our competitors and distributors,

RISK FACTORS

where significant market share can be rapidly acquired by such entities. Any such events may materially and adversely affect our market share, business, financial condition and results of operations.

In addition, we cannot assure you that we would be able to expand our market share gradually as planned or even maintain our current market share in the future. If we are unable to achieve our business target with respect to our market share or our market share shrinks as a result of various unexpected reasons, our market share, business, financial condition and results of operations could be materially and adversely affected.

We require various approvals and licenses to operate our business, and the loss of, or failure to obtain or renew, any or all of these approvals and licenses could materially and adversely affect our business.

Our production facilities in Hong Kong and Dongguan, the PRC require relevant licenses from the relevant government authorities in Hong Kong and the PRC, respectively, to carry on the business of food processing, including food distribution licenses and food operation licenses. The details of such licenses are set out in the sections headed “Regulatory Overview” and “Business — Licensing, Approvals and Applications” of this prospectus. These licenses are generally valid for one to five years and subject to renewal. The respective authorities will conduct random inspections on our premises to ensure that we are in compliance with the required regulations. If there is a breach of any restriction or condition subject to which the license was granted, the license may be temporarily or permanently suspended or revoked, which could disrupt our operation and materially and adversely affect our business.

The requirements set by the government authorities are also subject to change and new requirements may be imposed from time to time. We cannot assure you that the requirements set by the government authorities will always be met by us. As such, should our licenses be suspended or revoked, we will not be able to continue our production, which will result in a drop in production levels and prevent us from meeting the needs of our customers. In turn, such development will have a material and adverse impact on our turnover and profitability, as well as our business, financial condition and results of operations.

We may be subject to higher environmental related compliance costs if the Hong Kong and the PRC environmental protection laws become more onerous, and non-compliance with relevant environmental protection laws could lead to imposition of fines and penalties and harm our business and results of operations.

Our business is subject to Hong Kong’s and the PRC’s environmental protection laws and regulations with details set out in the section headed “Regulatory Overview” in this prospectus. These laws and regulations require us to adopt effective measures to control smoke emission and properly dispose of waste materials, waste water and other environmental waste materials, as well as fee payments from manufacturers discharging waste substances. Fines may be levied against us if we cause pollution in excess of permitted levels or otherwise fail to comply with such laws or regulations. If the circumstances of the breach are serious, the Hong Kong or the PRC government may suspend or close any

RISK FACTORS

operation failing to comply with such laws or regulations. There can be no assurance that we will not be involved in or be accused of any environmental claims or regulatory proceedings for violation of any applicable environmental protection laws and regulations in the future, which could subject us to civil remedies or administrative penalty, including fines, injunctions, as well as potential criminal sanctions. Any environmental non-compliance incidents could materially and adversely affect our business, financial condition and results of operations.

There can also be no assurance that the Hong Kong and the PRC governments will not change the existing laws or regulations or impose additional or stricter laws or regulations in this regard compliance with which may cause us to incur significant capital expenditure, which we may be unable to pass on to our customers by increasing the prices of our products and which may as a result materially and adversely affect our business, financial condition and results of operations.

Moreover, many countries have introduced recycling fees on the use of certain containers, particularly those made from glass, plastic or tin. Currently, there are no statutes or regulations requiring payment of these types of fees in Hong Kong or the PRC. However, if these types of fees were to be introduced in Hong Kong or the PRC, they could have a material and adverse effect on our business, financial condition and results of operations to the extent that we are unable to fully pass the relevant costs on to our customers, or that these types of regulations may deter consumers from purchasing related products.

We are exposed to foreign currency fluctuations, which may affect our business, financial condition and results of operations.

We incurred exchange differences arising from translation of the financial statements of our foreign operations registered in the PRC. We recorded losses of HK\$8.9 million and HK\$9.9 million for the years ended December 31, 2015 and 2016, respectively, from the translation of such foreign operations due to the depreciation of both the weighted average exchange rate of RMB/HK\$ during the periods and at the end of the reporting periods, and income of HK\$11.5 million for the year ended December 31, 2017 arising from the strengthening of the RMB. As we will continue to have operation in the PRC, exchange rate fluctuations may have adverse impact on our business, financial condition and results of operations.

We may incur additional costs due to changes in food safety laws to comply with the more stringent laws and regulations, which could materially and adversely affect our business and results of operations.

As a manufacturer of products intended for direct human consumption, we are subject to extensive food safety laws and regulations of Hong Kong and the PRC and other countries to which we distribute or sell our products. For instance, relevant Hong Kong food safety laws set out standards with respect to food and food additives, packaging and containers, as well as hygiene requirements for food production and sites, facilities and equipment used for the transportation and sale of food. In addition, recent amendments to

RISK FACTORS

the Food Safety Law of the PRC (《中華人民共和國食品安全法》) became effective on October 1, 2015. For further details regarding these laws and regulations, please refer to the section headed “Regulatory Overview” in this prospectus.

If we fail to comply with food safety laws in Hong Kong, the PRC or other jurisdictions in which we distribute or sell our products, we may be subject to fines, suspension of operations, loss of food production licenses and, in more extreme cases, criminal proceedings against us and our management. Any of these events would have an adverse impact on our production, business, financial condition and results of operations.

There can be no assurance that the Hong Kong and the PRC governments or the governmental authorities of other jurisdictions in which we distribute or sell our products will not impose additional or stricter laws or regulations on food safety, providing for stricter and more comprehensive monitoring and regulation of food manufacturers and distributors in areas including food production and distribution, which may lead to an increase in our costs of complying with such laws or regulations. We may be unable to pass these additional costs on to our customers, and we cannot assure you that we are capable of fully complying with future laws and regulations, which may result in an adverse effect on our business, financial condition and results of operations.

RISKS RELATING TO HONG KONG

Political and economic risks associated with conducting business in Hong Kong.

Most of our business operations are conducted in Hong Kong, and majority of our revenue is derived from sales in Hong Kong. Accordingly, our business, financial condition and results of operations are affected significantly by economic, political and legal developments in Hong Kong. Hong Kong is a special administrative region of the PRC and the basic policies of the PRC regarding Hong Kong are reflected in the Basic Law (基本法), Hong Kong’s constitutional document, which provides Hong Kong with a high degree of autonomy and executive, legislative and independent judicial powers, including that of final adjudication under the principle of “one country, two systems”. However, there is no assurance that there will not be any changes in the economic, political and legal environment in Hong Kong in the future. Our business, financial condition and results of operations may be affected should there be any material adverse change in the stability and development of the economic, political and legal environment of Hong Kong.

Because we generate a majority of our revenue in Hong Kong, we are susceptible to developments in Hong Kong.

Revenue generated from Hong Kong amounted to HK\$612.7 million, HK\$628.6 million and HK\$697.4 million for the years ended December 31, 2015, 2016 and 2017, respectively, representing 73.1%, 74.0% and 73.0% of our total revenue for the same periods, respectively. We anticipate that our business in Hong Kong will continue to contribute materially to our results of operations following the completion of the Global Offering. If Hong Kong experiences any adverse economic conditions due to events beyond our control, such as local economic downturn, natural disasters, contagious disease outbreaks or terrorist attacks, or if the local authorities adopt regulations that place

RISK FACTORS

additional restrictions or burdens on us or on our industry in general, our business, financial condition and results of operations may be materially and adversely affected. In addition, we may have difficulties expanding into new markets. Therefore, if there is any deterioration in the development in Hong Kong, our business, financial condition and results of operations may be materially and adversely affected.

RISKS RELATING TO THE PRC

Changes in political, legal, social and economic policies in the PRC may materially and adversely affect our prospects, business, financial condition and results of operations.

The PRC's economy differs from the economies of most developed countries in many respects, including structure, government involvement, level of development, growth rate, control of foreign exchange, capital reinvestment, allocation of resources, rate of inflation and balance of payments position. The economy of the PRC has been transitioning from a planned economy to a more market-oriented economy. In recent years, the PRC government has implemented measures emphasizing market forces for economic reform, reduction of state ownership of productive assets and establishment of sound corporate governance in business enterprises. However, a large portion of productive assets in the PRC are still state-owned. The PRC government continues to play a significant role in regulating industrial development, allocation of resources, production, pricing and management, and there can be no assurance that the PRC government will continue to pursue a consistent policy of economic reform.

Our business, financial condition and results of operations could be materially and adversely impacted by changes in economic, political, legal and social developments and conditions in the PRC and policies adopted by the PRC government, such as changes in laws and regulations (or the interpretation thereof).

Our business, financial condition and results of operations could also be materially and adversely affected by changes in measures introduced to control inflation, changes in the rate or method of taxation, imposition of additional restrictions on currency conversion, imposition of additional import restrictions and other state-driven changes. Moreover, although the PRC's economy has grown significantly in recent years, its continued growth has been facing downward pressure, and the annual GDP growth rate declined from 7.8% in 2013 to 6.9% in 2017 (based on preliminary statistics), according to National Bureau of Statistics of the PRC (中華人民共和國國家統計局). There is no assurance that the economy of the PRC will continue to grow or that its growth will be steady or sustained at similar rates at all or occur in geographical regions or economic sectors from which we benefit. A downturn in the PRC's economic growth or a decline in its economic condition may have a material and adverse effect on our business, financial condition and results of operations.

Uncertainties in the PRC legal system may materially and adversely affect our business and limit the legal protection available to us and our investors.

The PRC legal system is a civil law system based on written statutes and regulations. Unlike in the common law system, prior court decisions may be cited for reference but have limited precedential value. Since 1979, PRC legislation and regulations have significantly

RISK FACTORS

enhanced the protections afforded to various forms of foreign investments in the PRC. However, PRC has not developed a fully integrated legal system, and recently enacted laws and regulations may not sufficiently cover all aspects of economic activities in the PRC. We have several subsidiaries established in the PRC. These subsidiaries are generally subject to laws and regulations applicable to foreign investment in the PRC and, in particular, laws applicable to wholly foreign-owned enterprises.

In addition, our offshore holding companies and certain transactions between them may be subject to various PRC laws and regulations. However, since these laws and regulations are relatively new, published court decisions are limited in number and non-binding, and as the PRC legal system continues to rapidly evolve, the interpretations of many laws, regulations and rules are not always uniform, and enforcement of these laws, regulations and rules involve uncertainties, which may limit legal protections available to us and could subject us to unexpected liabilities. For example, we may have to resort to administrative and court proceedings to enforce the legal protection that we enjoy either by law or contract. However, since PRC administrative and court authorities have significant discretion in interpreting and implementing statutory and contractual terms, it may be more difficult to evaluate the outcome of administrative and court proceedings and the level of legal protection we enjoy in the PRC than in more developed legal systems. These uncertainties may impede our ability to enforce the contracts we have entered into with our business partners, customers, distributors and suppliers and could have a material and adverse effect on our business, financial condition and results of operations.

Furthermore, intellectual property rights and confidentiality protections in the PRC may not be as effective as in other countries. Since PRC legal system is based in part on government policies and administrative rules (some of which may not be published on a timely basis or at all) that may have retroactive effects, we may not be aware of our violations of these policies and rules until sometime after the violation and may be subject to fines and other penalties applied retroactively for violations of policies and rules enacted in the future based on acts that are currently permissible. Accordingly, we cannot predict the effect of future developments in the PRC legal system, including the promulgation of new laws, changes to existing laws or the interpretation or enforcement thereof, or the pre-emption of local regulations by national laws. These uncertainties could limit the legal protections available to us and our investors. In addition, any litigation in the PRC may be protracted and result in substantial costs and diversion of our resources and management attention.

Government control of currency conversion and fluctuations in the exchange rates of Renminbi may materially and adversely affect our business, financial condition and results of operations and our ability to remit dividends.

Part of our operating costs and revenue we receive are denominated in Renminbi. The PRC government imposes controls on the convertibility of Renminbi into foreign currencies and, in certain cases, the remittance of currency out of the PRC. Under existing PRC foreign exchange regulations, payments under current account items, including dividend payments, interest payments and expenditure from trade-related transactions, can be made in foreign currencies without prior approval from SAFE but shall comply with certain

RISK FACTORS

procedural requirements, including presenting relevant documentary evidence of such transactions and conducting such transactions at designated foreign exchange banks within the PRC that have licenses to carry out foreign exchange business. However, approval from, registration or filing with SAFE and other appropriate government authorities is required for foreign currency conversions for payment under capital account items such as equity investments and repayment of loans denominated in foreign currencies. The PRC government may at its discretion restrict our access in the future to foreign currencies for current account transactions. To the extent that we are unable to convert currencies or remit our revenue into and/or out of the PRC to satisfy our currency demand, our business, financial condition and results of operations and our ability to remit dividends would be materially and adversely affected.

The exchange rates of Renminbi against foreign currencies, including Hong Kong dollar, are affected by factors including changes in the PRC's political and economic conditions. Since 1994, the conversion of Renminbi into foreign currencies, including Hong Kong dollar, has been based on rates set by the People's Bank of China, which are set daily based on the previous business day's interbank foreign exchange market rates and current exchange rates on the world financial markets. On July 21, 2005, the PRC government introduced a managed floating exchange rate system to allow the value of Renminbi to fluctuate within a regulated band based on market supply and demand and by reference to a basket of currencies. There can be no assurance that the PRC government will not in the future make further adjustments to the exchange rate system. Any fluctuation in exchange rates of Renminbi against the U.S. dollar, Euro or other foreign currencies may cause our costs for importing raw materials, machinery and equipment and our operating costs to be volatile. In addition, to the extent that we need to convert our revenue from Hong Kong dollar into Renminbi to pay our operating costs, appreciation of Renminbi against Hong Kong dollar would increase our operating costs in Hong Kong dollar terms.

As a holding company, we rely on the distribution by our PRC subsidiaries for funding.

We are a holding company incorporated in Bermuda, and we operate our business through our operating subsidiaries in Hong Kong and the PRC. We may rely on distributions to us by our PRC subsidiaries for part of our funding, including paying dividends to our Shareholders and to service any debt we may incur. The PRC laws permit dividends to be paid by our PRC subsidiaries only out of their distributable profits determined in accordance with the PRC generally accepted accounting principles (the "PRC GAAP"), which may differ from the accounting principles and standards generally accepted in many other jurisdictions.

The PRC laws require each of our PRC subsidiaries to maintain a general reserve fund of 10% of its after-tax profits based on the PRC GAAP, up to a maximum of 50% of its registered capital. Any of our PRC subsidiaries that is a foreign invested enterprise may also be required to set aside individual funds for staff welfare, bonuses and development in accordance with PRC laws. These reserve funds are not available for distribution as cash dividends. Additionally, factors such as cash flows, restrictions in debt instruments, withholding tax and other arrangements may restrict our PRC subsidiaries' ability to pay

RISK FACTORS

dividends to us and in turn restrict our ability to pay dividends to our Shareholders. Distributions by our PRC subsidiaries to us in forms other than dividends may also be subject to government approvals and taxes.

The PRC tax authorities have strengthened their scrutiny over transfers of equity interests in a PRC resident enterprise by a non-resident enterprise, which may negatively affect our business and our ability to conduct mergers, acquisitions or other investments and the value of your investment in our Company.

On February 3, 2015, SAT issued the Announcement on Several Issues concerning Enterprise Income Tax on Income from the Indirect Transfer of Assets by Non-Resident Enterprises (《關於非居民企業間接轉讓財產企業所得稅若干問題的公告》) (“Circular 7”). Circular 7 provides comprehensive guidelines relating to, and heightens the PRC tax authorities’ scrutiny on, indirect transfers by a non-resident enterprise of assets (including equity interests) of a PRC resident enterprise (the “**PRC Taxable Assets**”). For example, when a non-resident enterprise transfers equity interests in an overseas holding company that directly or indirectly holds certain PRC Taxable Assets and if the transfer is considered by the PRC tax authorities to have no reasonable commercial purpose than to evade enterprise income tax, Circular 7 allows the PRC tax authorities to reclassify this indirect transfer of PRC Taxable Assets into a direct transfer and impose on the non-resident enterprise a 10% rate of PRC enterprise income tax. Circular 7 exempts this tax, for example, (i) where a non-resident enterprise derives income from an indirect transfer of the PRC Taxable Assets by acquiring and selling shares of a listed overseas holding company in the public market, and (ii) where a non-resident enterprise transfers the PRC Taxable Assets that it directly holds and an applicable tax treaty or arrangement exempts this transfer from PRC enterprise income tax. It remains unclear whether any exemptions under Circular 7 will be applicable to any future mergers, acquisitions or other investments that we may make outside the PRC involving PRC Taxable Assets or to transfers of our Shares by our Shareholders. If the PRC tax authorities impose PRC enterprise income tax on these activities, our ability to expand our business or seek financing through these transactions and the value of your investment in our Shares may be materially and adversely affected.

There is uncertainty regarding the PRC withholding tax rate that will be applied to distribution from the PRC.

The EIT Law provides that a withholding tax at the rate of 10% is applicable to dividends and other distributions payable by a PRC resident enterprise to investors who are “non-resident enterprises” (that do not have an establishment or place of business in the PRC or that have such establishment or place of business but the relevant dividend or other distribution is not effectively connected with the establishment or place of business). However, pursuant to the Arrangement between Mainland China and Hong Kong for the Avoidance of Double Taxation and the Prevention of Fiscal Evasion with respect to Taxes on Income (《內地和香港特別行政區關於對所得避免雙重徵稅和防止偷漏稅的安排》) (the “**PRC-HK Tax Arrangement**”) effective on December 8, 2006, the withholding tax rate on dividends paid by a PRC resident enterprise to a Hong Kong resident is 5% if such Hong Kong resident directly holds at least 25% of the equity interests in the PRC resident enterprise; otherwise, the dividend withholding tax rate is 10%. According to the Notice of

RISK FACTORS

the PRC State Administration of Taxation on Issues concerning the Application of the Dividend Clauses of Tax Agreements (《國家稅務總局關於執行稅收協定股息條款有關問題的通知》) promulgated on February 20, 2009 and effective on the same day, the corporate recipient of dividends distributed by PRC resident enterprises must satisfy the direct ownership thresholds at all times during the 12 consecutive months preceding the receipt of the dividends. The SAT issued the Announcement of the State Administration of Taxation on Issues concerning “Beneficial Owners” in Tax Treaties (《國家稅務總局關於稅收協定中“受益所有人”有關問題的公告》) on February 3, 2018, and the Measures for the Administration of Non-Resident Taxpayers’ Enjoyment of the Treatment under Tax Agreements (《非居民納稅人享受稅收協定待遇管理辦法》) on August 27, 2015. Pursuant to these regulations, non-resident taxpayers should judge by themselves whether they are entitled to the treatment of the tax convention, and faithfully declare and submit the relevant report and information to the competent tax authorities or actively propose to the withholding agents and provide relevant report and information to them. However, if a company is deemed to be a pass-through entity rather than a qualified owner of benefits, it cannot enjoy the favorable tax treatments provided in the PRC-HK Tax Arrangement. In addition, if transactions or arrangements are deemed by the relevant tax authorities to be entered into mainly for the purpose of enjoying favorable tax treatments under the PRC-HK Tax Arrangement, such favorable tax treatments may be subject to adjustment by the relevant tax authorities in the future.

Current PRC regulations on loans provided by, and foreign direct investment by, an offshore holding company to PRC companies may delay or prevent us from using the proceeds from the Global Offering to fund our business operations in the PRC.

Our Company or other members of our Group may make loans, or additional capital contributions, to our PRC subsidiaries by utilizing the proceeds we receive from the Global Offering. Any loans to our PRC subsidiaries are subject to PRC regulations and approvals. For example, loans by us to our wholly-owned PRC subsidiaries cannot exceed the statutory limit, and must be registered with SAFE or its local counterpart. We may also decide to finance our PRC subsidiaries through capital contributions. According to the relevant PRC regulations on foreign-invested enterprises, depending on the amount of total investment and the type of business in which a foreign-invested enterprise is engaged in, capital contributions to foreign-invested enterprises in the PRC are subject to approval by MOFCOM or its local counterpart and register with SAIC or its local counterpart. There is no assurance that we will be able to obtain required government registrations or approvals on a timely basis, or at all, with respect to our future loans or capital contributions to our PRC subsidiaries or their respective subsidiaries. If we fail to receive such registrations or approvals, our ability to use the proceeds received from the Global Offering and to fund our PRC operations may be negatively affected, which may have a material and adverse effect on our business, financial condition and results of operations.

RISK FACTORS

RISKS RELATING TO THE GLOBAL OFFERING

There has been no prior public market in Hong Kong for our Shares, and the market price and trading volume of our Shares may be volatile, which may result in substantial losses for investors in our Shares.

There has been no public market in Hong Kong for our Shares. The initial Offer Price for our Shares to the public will be the result of negotiations between our Company (for ourselves and on behalf of the Selling Shareholder) and the Sole Global Coordinator (for itself and on behalf of the Underwriters), and the Offer Price may differ significantly from the market price of the Shares following the Global Offering. We have applied to the Hong Kong Stock Exchange for the listing of, and permission to deal in, the Shares. A listing on the Hong Kong Stock Exchange, however, does not guarantee that an active and liquid trading market for the Shares will develop, or that if it does develop, it will be sustained following the Global Offering, or that the market price of the Shares will not decline following the Global Offering.

Furthermore, following the Global Offering, the market price and trading volume of the Shares could be subject to significant fluctuations due to various external factors and events as a result of, without limitation, the following factors, some of which are beyond our control:

- the liquidity and depth of the Shares in the market;
- difference between our actual financial condition or results of operations and those expected by investors and analysts;
- changes in analysts' estimates of our financial performance;
- investors' perceptions of our Group and the general investment environment;
- announcements by us of significant acquisitions, strategic alliances or joint ventures;
- regulatory developments affecting us, our business partners, our customers, our suppliers and/or our competitors;
- developments in the food and beverage industry;
- fluctuations in stock market prices and liquidity;
- changes in pricing policies adopted by us or our competitors;
- additions or departures of our key personnel;
- involvement in litigation;
- any unexpected business interruptions resulting from, among others, natural disasters or power shortages;

RISK FACTORS

- liability claims brought against us based on matters such as product liability;
- forced discontinued sale of our products;
- release or expire of lock-up or other transfer restrictions on our Shares;
- sales or perceived sales of additional Shares;
- actions taken by our competitors;
- our ability to compete effectively in the market;
- our ability to obtain or maintain regulatory approvals, licenses and permits of our operations and products; and
- general political, economic, financial, social development and stock market conditions.

If an active trading market for our Shares does not develop or is not sustained after the Global Offering, the market price and liquidity of our Shares could be materially and adversely affected. In addition, in recent years, stock markets in general have experienced price and volume fluctuations, some of which were unrelated or did not fully correspond to the operating performance of such companies. These broad market and industry fluctuations may materially and adversely affect the market price of the Shares.

There will be a time gap of several business days between pricing and dealing of our Shares offered under the Global Offering. The market price of the Shares after dealing begins could be lower than the Offer Price.

The Offer Price of our Shares is expected to be determined on the Price Determination Date. However, our Shares will not commence dealing on the Hong Kong Stock Exchange until they are delivered, which is expected to be seven business days in Hong Kong after the pricing date. As a result, investors may not be able to sell or otherwise deal in our Shares during that period. Accordingly, holders of our Shares are subject to the risk that the price of our Shares could fall before dealing begins as a result of adverse market conditions or other adverse developments that could occur between the time of pricing and the time of dealing beginning.

Control by our Controlling Shareholders of a substantial percentage of our Shares after the completion of the Global Offering may limit your ability to influence the outcome of decisions requiring the approval of Shareholders, and the interests of our Controlling Shareholders may not be aligned with ours and those of our other Shareholders.

Our Controlling Shareholders, Hero Valour and Mr. Wong (through his interests in Hero Valour), will, upon completion of the Global Offering, continue to beneficially own in aggregate a substantial percentage of our Shares. For further details, please refer to the section headed “Relationship with Our Controlling Shareholders” in this prospectus. Therefore, they will be able to exercise significant influence over all matters requiring

RISK FACTORS

Shareholders' approval, including the election of directors, selection of senior management, amendments to our Bye-Laws and the approval of significant corporate transactions, such as mergers and disposal of assets. They will also have veto power with respect to any shareholder action or approval requiring a majority vote except where they are required by relevant rules to abstain from voting. Such concentration of ownership also may have the effect of delaying, preventing, discouraging or deterring a change in control of our Company that would otherwise benefit our Shareholders. The interests of the Controlling Shareholders may not always coincide with our Company's or our Shareholders' best interests. If the interests of the Controlling Shareholders conflict with the interests of our Company or other Shareholders, or if the Controlling Shareholders choose to cause our business to pursue strategic objectives that conflict with the interests of our Company or other Shareholders, our Company or those other Shareholders may be disadvantaged as a result.

Future sales or major divestment of our Shares by any of our Controlling Shareholders or the cornerstone investors could materially and adversely affect the prevailing market price of our Shares.

Any future sale or availability of the Shares can have an adverse effect on the Share price. The sale of a significant amount of Shares in the public market after the Global Offering, or the perception that such sales may occur, could materially and adversely affect the market price of the Shares. Except as otherwise described in the section headed "Underwriting — Underwriting Arrangements and Expenses — Undertakings pursuant to the Hong Kong Underwriting Agreement" in this prospectus, there are no restrictions imposed on the Controlling Shareholders to dispose of their shareholdings. We cannot assure that they will not dispose of these Shares following the expiration of the lock-up periods or any Shares they may come to own in the future. Any major disposal of Shares by any of the Controlling Shareholders after the expiry of the lock-up periods after Listing may cause the market price of the Shares to fall. Between the seventh and twelfth months after Listing, the Controlling Shareholders may not dispose of their Shares to the extent that would cause them to cease to be "Controlling Shareholders" under the Listing Rules. In addition, these disposals may make it more difficult for us to issue new Shares in the future at a time and price we deem appropriate, thereby limiting our ability to raise capital.

You will experience immediate and substantial dilution in the book value of your investment as a result of the Global Offering and may experience further dilution or restrictions if we issue additional Shares in the future.

In order to raise capital and expand our business, we may consider offering and issuing additional Shares or other securities convertible into or exchangeable for our Shares in the future other than on a pro rata basis to our then existing Shareholders. As a result, the shareholdings of those Shareholders may experience dilution in net asset value per Share

RISK FACTORS

and such new securities may confer rights and privileges such as pre-emptive rights or options that might take priority over those conferred by the Shares. In addition, if additional funds are to be raised through debt financing, certain restrictions may be imposed on our operations, which may:

- further limit our ability or discretion to pay dividends or require us to seek consents for payment of dividends;
- increase our risks in adverse economic and industry conditions;
- materially and adversely affect our cash flows, thereby reducing the availability of our cash flow to fund capital expenditure, working capital requirements and other general corporate needs; or
- limit our flexibility in business development and strategic plans.

There is no assurance of whether or when we will pay dividends.

We declared dividends with an amount of HK\$28.1 million, HK\$23.3 million and HK\$122.9 million to our then Shareholders during the years ended December 31, 2015, 2016 and 2017, respectively, which were paid in cash or settled through current account. We also declared a final dividend for the year of 2017 totalling HK\$10.0 million in January 2018, which was settled in cash, and an interim dividend for the year ending December 31, 2018 totalling HK\$8.1 million in April 2018, which has not been settled as at the Latest Practicable Date. There is no assurance that further dividends will be declared or paid in an amount equivalent to or exceeding historical dividends declared or at all. Investors are cautioned not to use historical dividends as an indication of the amount of future dividends to be declared or paid. The declaration, payment and amount of any future dividends are subject to the discretion of our Directors depending on, amongst other things, our earnings, financial position, cash requirements, provisions governing the declaration and distribution as contained in our Bye-Laws, the Companies Act, applicable law and other relevant factors. We may not have sufficient or any profits to enable us to make dividend distributions to our Shareholders in the future, even if our financial statements indicate that our operations have been profitable. For further details, please refer to the section headed “Financial Information — Dividends” in this prospectus.

We have significant discretion as to how we will use the net proceeds of the Global Offering, and you may not necessarily agree with how we use them.

Our management may spend the net proceeds from the Global Offering in ways you may not agree with or that do not yield a favorable return to our Shareholders. We plan to use the net proceeds from the Global Offering, including capital investments in relation to acquiring, expanding, streamlining or upgrading our manufacturing plants, premises and facilities. See the section headed “Future Plans and Use of Proceeds — Use of Proceeds” in this prospectus for more information. However, our management will have discretion as to the actual application of our net proceeds. You are entrusting your funds to our management, upon whose judgment you must depend, for the specific uses we will make of the net proceeds from the Global Offering.

RISK FACTORS

The facts, forecasts and other statistics obtained from government sources and other third parties contained in this prospectus may not be accurate, and statistics in this prospectus are subject to assumptions and methodologies set forth in the “Industry Overview” section of this prospectus.

Facts, forecasts and other statistics in this prospectus relating to Hong Kong, Macau and the PRC, including their economies, the B2B coffee and black tea market, the frozen meat products market and the frozen processed food products market, have been derived from various sources. We have taken reasonable care in the reproduction or extraction of the official government publications or other third party reports we generally believe to be reliable for the purpose of disclosure in this prospectus. We have no reason to believe that such information is false or misleading in any material respect or that any facts have been omitted that would render such information false or misleading in any material respect. However, we cannot guarantee the reliability of such source materials. Such information has not been prepared or independently verified by us, the Selling Shareholder, the Sole Global Coordinator, the Joint Sponsors, the Underwriters or any of our or their respective affiliates, directors or advisors. Therefore, we make no representation as to the accuracy of such facts, forecasts and statistics contained in such official government publications or third party reports. Furthermore, we cannot assure you that they are stated or compiled on the same basis or with the same degree of accuracy as similar statistics presented elsewhere. In all cases, investors should give consideration as to how much weight or importance they should attach or place on such facts, forecasts or statistics.

This prospectus contains forward-looking statements relating to our plans, objectives, expectations and intentions, which may not represent our overall performance for periods of time to which such statements relate.

This prospectus contains forward-looking statements and information relating to us and our operations and prospects that are based on our current beliefs and assumptions as well as information currently available to us. When used in this prospectus, terminology such as “aim”, “anticipate”, “believe”, “could”, “consider”, “estimate”, “expect”, “going forward”, “intend”, “is/are likely to”, “may”, “ought to”, “plan”, “project”, “prospects”, “seek”, “should”, “will”, “would” and the negative of these words and other similar expressions, as they relate to us or our business or our management, are intended to identify forward-looking statements, but the absence of these words does not necessarily mean that a statement is not forward looking. Those statements include, without limitation, the discussion of our growth strategy and expectations concerning our future operations, liquidity and capital resources and reflect our current views with respect to future events and are subject to risks, uncertainties and various assumptions, including the following:

- our business prospects;
- our future debt levels and capital needs;
- future developments, trends and conditions in the industry and markets in which we operate;

RISK FACTORS

- our business strategies and plans to achieve these strategies;
- general economic, political and business conditions in the markets in which we operate;
- changes to the regulatory environment and general outlook in the industry and markets in which we operate;
- the effects of the global financial markets and economic crisis;
- our ability to reduce costs;
- our dividend policy;
- our capital expenditure plans;
- the amount and nature of, and potential for, future development of our business;
- capital market developments;
- the actions and developments of our competitors; and
- change or volatility in interest rates, foreign exchange rates, equity prices, volumes, operations, margins, risk management and overall market trends.

Purchasers of our Shares are cautioned that reliance on any forward-looking statement involves risk and uncertainties. Any or all of those assumptions could prove to be inaccurate, and, as a result, the forward-looking statements based on those assumptions could be incorrect. The risks and uncertainties in this regard include those identified in this “Risk Factors” section, many of which are not within our control. In light of these and other risks and uncertainties, the inclusion of forward-looking statements in this prospectus should not be regarded as representations or warranties by us that our plans and objectives will be achieved and investors shall not place undue reliance on such forward-looking statements and information. We do not undertake any obligation to update publicly or release any revisions of any forward-looking statements, whether as a result of new information, future events or otherwise.

Should one or more of these risks or uncertainties materialize, or should any of the underlying assumptions prove incorrect, actual results may diverge significantly from the forward-looking statements in this prospectus. We do not intend to update these forward-looking statements in addition to our on-going disclosure obligations pursuant to the Listing Rules or other requirements of the Hong Kong Stock Exchange.

Accordingly, investors shall not place undue reliance on any forward-looking statements and information. All forward-looking statements and information in this prospectus are qualified by reference to this cautionary statement.

RISK FACTORS

This prospectus contains certain hypothetical information based on changes relative to historical events and related analysis based on it, and you should not place undue reliance on such information or analysis.

This prospectus contains certain hypothetical information and analysis based on it, which includes the use of certain accompanying assumptions, in particular in respect of historical prices of coffee beans and processed tea leaves. Our Company cannot offer assurances that the assumptions would have been true under the hypotheses presented or that the results of these hypothetical changes would have matched the results presented. For details, please refer to the section headed “Financial Information — Factors Affecting Our Results of Operations — Raw material cost” in this prospectus. Given the hypothetical nature of this information and the uncertainty of the assumptions made, the results that would have resulted under these hypotheses might not have occurred in the way we had expected. Accordingly, you should not place undue reliance on the hypothetical information and related analysis included in this prospectus.

You may experience difficulties in enforcing your shareholder rights because we are incorporated in Bermuda, and Bermuda law may be different from the laws of Hong Kong or other jurisdictions in terms of minority shareholder protection.

Our Company was incorporated in Bermuda, and its affairs are governed by, among other things, the Bye-Laws, the Companies Act and common law applicable in Bermuda. The laws of Bermuda may differ from those of Hong Kong or other jurisdictions where investors may be located. As a result, minority Shareholders may not enjoy the same rights as pursuant to the laws of Hong Kong or such other jurisdictions. A summary of Bermuda company law on protection of minority shareholders is set out in the paragraph headed “Summary of the Constitution of our Company and Bermuda Company Law — 3. Bermuda Company Law” in Appendix III to this prospectus.

Although we will be subject to the Listing Rules and the Takeovers Code upon the Listing, Shareholders will not be able to bring actions on the violations of the Listing Rules and the Takeovers Code, which do not have the force of law in Hong Kong. Shareholders must rely on the Hong Kong Stock Exchange to enforce the Listing Rules, and the Takeovers Code only provides standards of commercial conduct considered acceptable for takeover and merger transactions and share repurchases in Hong Kong.

RISK FACTORS

Investors should read the entire prospectus carefully and should not place any reliance on any information contained in press articles or other media in making your investment decision.

Prior or subsequent to the publication of this prospectus, there may have been or be press and media coverage regarding us and the Global Offering, which includes certain information about us that does not appear in, or is different to what is contained in, this prospectus. We have not authorized the disclosure of any such information in the press or media. Financial information, financial projections, valuation and other information about us contained in such unauthorized press or media coverage may not truly reflect what is disclosed in this prospectus or the actual circumstances. We do not accept any responsibility for such unauthorized press and media coverage or for the accuracy or completeness of any such information. We make no representation as to the appropriateness, accuracy, completeness or reliability of any such information. To the extent that any information appearing in the press and media is inconsistent or conflicts with the information contained in this prospectus, we disclaim it. Investors should rely only on the information contained in this prospectus in making an investment decision. By applying to purchase our Shares in the Global Offering, investors will be deemed to have agreed that you will not rely on any information other than that contained in this prospectus and the Application Forms.

WAIVERS FROM STRICT COMPLIANCE WITH THE LISTING RULES AND EXEMPTION FROM THE COMPANIES (WINDING UP AND MISCELLANEOUS PROVISIONS) ORDINANCE

In preparation for the Listing, we have sought the following waivers from strict compliance with the Listing Rules and exemption from the Companies (Winding Up and Miscellaneous Provisions) Ordinance:

1. CONTINUING CONNECTED TRANSACTIONS

Our Group has entered into certain transactions which would constitute continuing connected transactions of our Company pursuant to Chapter 14A of the Listing Rules upon Listing. We have applied to the Hong Kong Stock Exchange for, and the Hong Kong Stock Exchange has granted our Company, a waiver in relation to certain continuing connected transactions under Chapter 14A of the Listing Rules. Further details of such continuing connected transactions and the waiver are set out in the section headed “Continuing Connected Transactions” in this prospectus.

2. PRE-IPO SHARE OPTION SCHEME

Pursuant to Rule 17.02(1)(b) of the Listing Rules, our Company is required to disclose in this prospectus full details of all outstanding pre-IPO options and their potential dilution effect on the shareholdings upon Listing as well as the impact on the earnings per Share arising from the exercise of such outstanding pre-IPO options in respect of the Pre-IPO Share Option Scheme. It is also required in paragraph 27 of Appendix 1A of the Listing Rules that our Company shall disclose particulars of any capital of any member of the Group which is under option, or agreed conditionally or unconditionally to be put under option, including the consideration for which the options were or will be granted and the price and duration of the options, and the names and addresses of the grantees.

Pursuant to section 342(1)(b) and paragraph 10 of Part I of the Third Schedule to the Companies (Winding Up and Miscellaneous Provisions) Ordinance, our Company is required to disclose in this prospectus the number, description and amount of any Shares which any person has, or is entitled to be given, an option to subscribe for, together with the particulars of the option, namely (a) the period during which it is exercisable; (b) the price to be paid for Shares subscribed for under it; (c) the consideration (if any) given or to be given for it or for the right to it; and (d) the names and addresses of the persons to whom it or the right to it was given or, if given to existing Shareholders as such, the relevant Shares.

We have granted options to 161 persons (the “**Grantees**” and each a “**Grantee**”) to subscribe for 9,000,000 Shares on the terms set out in “D. Share Option Schemes — 1. Pre-IPO Share Option Scheme” in Appendix IV to this prospectus including two Grantees who are executive Directors, five Grantees who are members of the senior management of our Group and two Grantees who are connected persons of our Company (collectively the “**Disclosed Grantees**” and each a “**Disclosed Grantee**”). Save as disclosed in “D. Share Option Schemes — 1. Pre-IPO Share Option Scheme” in Appendix IV to this prospectus, no other Grantee (the “**Other Grantees**”) is a director or member of the senior management of our Group or connected person of our Company.

**WAIVERS FROM STRICT COMPLIANCE WITH THE LISTING RULES AND
EXEMPTION FROM THE COMPANIES
(WINDING UP AND MISCELLANEOUS PROVISIONS) ORDINANCE**

We have applied for (i) a waiver from the Hong Kong Stock Exchange from strict compliance with the disclosure requirements under Rule 17.02(1)(b) and paragraph 27 of Appendix 1A to the Listing Rules; and (ii) a certificate of exemption under section 342A of the Companies (Winding Up and Miscellaneous Provisions) Ordinance exempting our Company from strict compliance with the disclosure requirements of paragraph 10(d) of Part I of the Third Schedule to the Companies (Winding Up and Miscellaneous Provisions) Ordinance on the ground that it would be unduly burdensome for us due to the following reasons:

- (i) the disclosure of key information of the options granted to the Disclosed Grantees, as described in “D. Share Option Schemes — 1. Pre-IPO Share Option Scheme” in Appendix IV to this prospectus should provide potential investors with sufficient information to make a relevant assessment of our Company in their investment decision-making process. Given that 152 Other Grantees are involved, strict compliance with the applicable disclosure requirements under the Listing Rules and the Companies (Winding Up and Miscellaneous Provisions) Ordinance for all the Other Grantees on an individual basis in this prospectus will be costly and unduly burdensome on our Company in light of a significant increase in cost and timing for information compilation, prospectus preparation and printing;
- (ii) among the 152 Other Grantees, none of them is Directors, members of the senior management or connected persons of our Group. These employees of the Group have been granted options under the Pre-IPO Share Option Scheme to subscribe for an aggregate of 5,210,000 Shares, representing approximately 0.72% of the total issued Shares immediately upon completion of the Global Offering (without taking into account any Shares which may be allotted and issued upon the exercise of the Over-allotment Option and the options which have been granted under the Pre-IPO Share Option Scheme or which may be granted under the Share Option Scheme), and the aggregate number of the Shares to be subscribed for pursuant to the exercise of these options was not material in the circumstances of our Company and the grant and exercise in full of the options granted under the Pre-IPO Share Option Scheme will not cause any material adverse change in the financial position of our Company;
- (iii) as the options granted under the Pre-IPO Share Option Scheme are in many instances considered as part of the Other Grantees’ remuneration package, information on such options is highly sensitive and confidential among the Other Grantees;
- (iv) a waiver from the Hong Kong Stock Exchange from strict compliance with the applicable disclosure requirements under the Listing Rules and an exemption from the SFC from strict compliance with disclosure requirements under the Companies (Winding Up and Miscellaneous Provisions) Ordinance will not hinder

**WAIVERS FROM STRICT COMPLIANCE WITH THE LISTING RULES AND
EXEMPTION FROM THE COMPANIES
(WINDING UP AND MISCELLANEOUS PROVISIONS) ORDINANCE**

our Company in providing an informed assessment of our Company's activities, assets and liabilities, financial position, management and prospects to our potential investors; and

- (v) the names and addresses of the 152 Other Grantees, as well as the number of Shares in respect of which options have been conditionally granted to each of the Other Grantees are immaterial information to potential investors to make a relevant assessment of our Company in their investment decision-making process.

Our Company has applied to the Hong Kong Stock Exchange for a waiver from strict compliance with the disclosure requirements under Rule 17.02(1)(b) and paragraph 27 of Appendix 1A to the Listing Rules and the Hong Kong Stock Exchange has granted our Company a waiver under the Listing Rules on the following conditions:

- (a) the grant of a certificate of exemption from strict compliance with the relevant requirements under the Companies (Winding Up and Miscellaneous Provisions) Ordinance by the SFC;
- (b) on individual basis, full details of all the options granted by our Company under the Pre-IPO Share Option Scheme to our Directors, senior management of our Group and the connected persons of our Company under the Pre-IPO Share Option Scheme, including all the particulars required under Rule 17.02(1)(b) of the Listing Rules and paragraph 27 of Appendix 1A to the Listing Rules, be disclosed in this prospectus;
- (c) in respect of the options granted by our Company to the Other Grantees, the following details be fully disclosed in this prospectus:
 - (1) the aggregate number of the Other Grantees;
 - (2) the number of Shares subject to such options and the percentage of the aggregate number of Shares to our Company's total issued share capital immediately after completion of the Global Offering (without taking into account any Shares which may be allotted and issued upon the exercise of the Over-allotment Option and the options which have been granted under the Pre-IPO Share Option Scheme or which may be granted under the Share Option Scheme);
 - (3) the consideration paid for the grant of such options;
 - (4) the exercise period of the options; and
 - (5) the exercise price for the options;

**WAIVERS FROM STRICT COMPLIANCE WITH THE LISTING RULES AND
EXEMPTION FROM THE COMPANIES
(WINDING UP AND MISCELLANEOUS PROVISIONS) ORDINANCE**

- (d) the dilution effect and impact on earnings per Share upon full exercise of the options granted under the Pre-IPO Share Option Scheme be disclosed in this prospectus;
- (e) the aggregate number of Shares subject to the outstanding options granted by our Company under the Pre-IPO Share Option Scheme and the percentage of our Company's issued share capital immediately after completion of the Global Offering (without taking into account any Shares which may be allotted and issued upon the exercise of the Over-allotment Option and the options which have been granted under the Pre-IPO Share Option Scheme or which may be granted under the Share Option Scheme) of which such number represents be disclosed in this prospectus;
- (f) a summary of the Pre-IPO Share Option Scheme be disclosed in this prospectus; and
- (g) the list of all the Grantees (including the Other Grantees), containing all details as required under Rule 17.02(1)(b) and paragraph 27 of Appendix 1A to the Listing Rules and paragraph 10 of Part I of the Third Schedule to the Companies (Winding Up and Miscellaneous Provisions) Ordinance be made available for public inspection.

The SFC has issued a certificate of exemption under section 342A of the Companies (Winding Up and Miscellaneous Provisions) Ordinance exempting our Company from strict compliance with paragraph 10(d) of Part I of the Third Schedule to the Companies (Winding Up and Miscellaneous Provisions) Ordinance subject to the conditions that:

- (aa) on individual basis, full details of all the options granted by our Company under the Pre-IPO Share Option Scheme to each of our Directors, senior management of our Group and connected persons of our Company are disclosed in this prospectus, such details to include all the particulars required under paragraph 10 of Part I of the Third Schedule to the Companies (Winding Up and Miscellaneous Provisions) Ordinance;
- (bb) in respect of the options granted by our Company under the Pre-IPO Share Option Scheme to the employees other than those referred to in sub-paragraph (aa) above, the following details are disclosed in this prospectus:
 - (1) the aggregate number of the Other Grantees;
 - (2) the number of Shares subject to such options;
 - (3) the consideration paid for the grant of such options;
 - (4) the exercise period of the options; and

**WAIVERS FROM STRICT COMPLIANCE WITH THE LISTING RULES AND
EXEMPTION FROM THE COMPANIES
(WINDING UP AND MISCELLANEOUS PROVISIONS) ORDINANCE**

- (5) the exercise price for the options;
- (cc) a list of all the Grantees (including the persons referred to in sub-paragraph (aa) above) who have been granted options to subscribe for Shares under the Pre-IPO Share Option Scheme, containing all the details as required under paragraph 10 of Part I of the Third Schedule to the Companies (Winding Up and Miscellaneous Provisions) Ordinance be made available for public inspection; and
- (dd) the particulars of the exemption will be disclosed in this prospectus.

Further details of the Pre-IPO Share Option Scheme are set out in “D. Share Option Schemes — 1. Pre-IPO Share Option Scheme” in Appendix IV to this prospectus.

INFORMATION ABOUT THIS PROSPECTUS AND THE GLOBAL OFFERING

DIRECTORS' RESPONSIBILITY FOR THE CONTENTS OF THIS PROSPECTUS

This prospectus includes particulars given in compliance with the Companies (Winding Up and Miscellaneous Provisions) Ordinance, the Securities and Futures (Stock Market Listing) Rules (Chapter 571V of the Laws of Hong Kong) (as amended) and the Listing Rules for the purpose of giving information to the public with regard to our Group. Our Directors collectively and individually accept full responsibility for the accuracy of the information contained in this prospectus. Our Directors confirm, having made all reasonable enquiries, that, to the best of their knowledge and belief, the information contained in this prospectus is accurate and complete in all material respects and not misleading or deceptive, and there are no other matters the omission of which would make any statement in this prospectus misleading.

INFORMATION ON THE GLOBAL OFFERING

The Hong Kong Offer Shares are offered solely on the basis of the information contained and representations made in this prospectus and the Application Forms and on the terms and subject to the conditions set out herein and therein. No person is authorized to give any information in connection with the Global Offering or to make any representation not contained in this prospectus and the relevant Application Forms, and any information or representation not contained herein and therein must not be relied upon as having been authorized by our Company, the Selling Shareholder, the Joint Sponsors, the Sole Global Coordinator, the Joint Bookrunners, the Joint Lead Managers, the Underwriters, any of their respective directors, agents, employees or advisors or any other party involved in the Global Offering. Neither the delivery of this prospectus nor any offering, sale or delivery made in connection with the Offer Shares should, under any circumstances, constitute a representation that there has been no change or development reasonably likely to involve a change in our affairs since the date of this prospectus or imply that the information contained in this prospectus is correct as of any date subsequent to the date of this prospectus.

The Selling Shareholder will offer 132,970,688 Sale Shares for sale under the Global Offering. For further details of the Sale Shares by the Selling Shareholder, please refer to the section headed "Structure of the Global Offering" in this prospectus.

UNDERWRITING

This prospectus is published solely in connection with the Hong Kong Public Offering, which forms part of the Global Offering. For applicants under the Hong Kong Public Offering, this prospectus and the Application Forms set out the terms and conditions of the Hong Kong Public Offering.

The Hong Kong Public Offering is fully underwritten by the Hong Kong Underwriters under the terms of the Hong Kong Underwriting Agreement and is subject to the Sole Global Coordinator (for itself and on behalf of the Underwriters) and our Company (for ourselves and on behalf of the Selling Shareholder) agreeing on the Offer Price.

INFORMATION ABOUT THIS PROSPECTUS AND THE GLOBAL OFFERING

RESTRICTIONS ON OFFER OF THE OFFER SHARES

Each person acquiring the Hong Kong Offer Shares under the Hong Kong Public Offering will be required to, or be deemed by his acquisition of Offer Shares to, confirm that he is aware of the restrictions on offers of the Offer Shares described in this prospectus and the relevant Application Forms.

No action has been taken to permit a public offering of the Offer Shares in any jurisdiction other than in Hong Kong, or the distribution of this prospectus and/or Application Forms in any jurisdiction other than Hong Kong. Accordingly, this prospectus and/or Application Forms may not be used for the purpose of, and does not constitute, an offer or invitation in any jurisdiction or in any circumstances in which such an offer or invitation is not authorized or to any person to whom it is unlawful to make such an offer or invitation. The distribution of this prospectus and the offering of the Offer Shares in other jurisdictions are subject to restrictions and may not be made except as permitted under the applicable securities laws of such jurisdictions pursuant to registration with or authorization by the relevant securities regulatory authorities or an exemption therefrom.

APPLICATION FOR LISTING ON THE HONG KONG STOCK EXCHANGE

The Listing is sponsored by the Joint Sponsors. We have applied to the Listing Committee for the granting of the listing of, and permission to deal in, the Shares in issue and to be issued pursuant to the Global Offering (including any additional Shares which may be issued pursuant to the exercise of the Over-allotment Option and the options which have been granted under the Pre-IPO Share Option Scheme and which may be granted under the Share Option Scheme).

Our Company was listed on SGX-ST in December 2001 and delisted on October 3, 2013 after a compulsory acquisition pursuant to Section 103(1) of the Bermuda Companies Act. Save as disclosed in this prospectus, no part of our Company's share or loan capital is listed on or dealt in on any other stock exchange and no such listing or permission to list is being or proposed to be sought in the near future.

COMMENCEMENT OF DEALINGS IN THE SHARES

Dealings in the Shares on the Hong Kong Stock Exchange are expected to commence on May 11, 2018. The Shares will be traded in board lots of 2,000 Shares each. The stock code of the Shares will be 2119.

SHARES WILL BE ELIGIBLE FOR ADMISSION INTO CCASS

If the Hong Kong Stock Exchange grants the listing of, and permission to deal in, our Shares and we comply with the stock admission requirements of HKSCC, our Shares will be accepted as eligible securities by HKSCC for deposit, clearance and settlement in CCASS with effect from the Listing Date or any other date as determined by HKSCC. Settlement of transactions between participants of the Hong Kong Stock Exchange is required to take place in CCASS on the second business day after any trading day. All activities under CCASS are subject to the General Rules of CCASS and CCASS Operational Procedures in

INFORMATION ABOUT THIS PROSPECTUS AND THE GLOBAL OFFERING

effect from time to time. Investors should seek the advice of their stockbroker or other professional advisor for details of the settlement arrangement as such arrangements may affect their rights and interests. All necessary arrangements have been made enabling the Shares to be admitted into CCASS.

HONG KONG BRANCH SHARE REGISTER AND STAMP DUTY

Our Company's principal share register will be maintained by our Principal Share Registrar, Estera Management (Bermuda) Limited, in Bermuda and our Company's Hong Kong branch share register will be maintained by our Hong Kong Share Registrar, Tricor Investor Services Limited, in Hong Kong.

All Offer Shares will be registered on the Hong Kong branch share register of our Company in Hong Kong. Dealings in the Shares registered on our Hong Kong branch share register will be subject to Hong Kong stamp duty.

PROFESSIONAL TAX ADVICE RECOMMENDED

Potential investors in the Global Offering are recommended to consult their professional advisors if they are in any doubt as to the taxation implications of subscribing for, purchasing, holding or disposal of, and dealing in our Shares (or exercising rights attached to them). None of us, the Sole Global Coordinator, the Joint Sponsors, the Joint Bookrunners, the Joint Lead Managers, the Underwriters, the Selling Shareholder, any of our or their respective directors, officers or representatives or any other person or party involved in the Global Offering accepts responsibility for any tax effects on, or liabilities of, any person resulting from the subscription for, purchase, holding or disposal of, dealing in, or the exercise of any rights in relation to, our Shares.

EXCHANGE RATE CONVERSION

Solely for your convenience, this prospectus contains translations of certain Renminbi amounts into Hong Kong dollars at specified rates.

Unless we indicate otherwise, the translation of Renminbi into Hong Kong dollars, and vice versa, in this prospectus was made at the following rate:

RMB0.80142 to HK\$1.00

No representation is made that any amounts in Renminbi or Hong Kong dollars can be or could have been at the relevant dates converted at the above rates or any other rate or at all.

INFORMATION ABOUT THIS PROSPECTUS AND THE GLOBAL OFFERING

LANGUAGE

If there is any inconsistency between this prospectus and the Chinese translation of this prospectus, this prospectus shall prevail. Translated English names of Chinese laws and regulations, governmental authorities, departments, entities (including certain of our subsidiaries), institutions, natural persons, facilities, certificates, titles and the like included in this prospectus, for which no official English translation exists, are unofficial translations for identification purposes only. In the event of any inconsistency, the Chinese name prevails.

ROUNDING

Unless otherwise stated, all the numerical figures are rounded to one decimal place. Any discrepancies in any table or chart between totals and sums of amounts listed therein are due to rounding.

DIRECTORS AND PARTIES INVOLVED IN THE GLOBAL OFFERING

DIRECTORS

Name	Residential Address	Nationality
-------------	----------------------------	--------------------

Executive Directors

Mr. Wong Tat Tong (黃達堂先生)	House H3 Bellevue Place 93 Repulse Bay Road Hong Kong	Chinese
------------------------------	--	---------

Mr. Wu Kam On Keith (鄔錦安先生)	Flat D, 6th Floor Tower 18 Mayfair By The Sea I 23 Fo Chun Road Tai Po, New Territories Hong Kong	Chinese
--------------------------------	--	---------

Ms. Fan Yee Man (樊綺敏小姐)	Room 1413 Lung Chu House Lung Poon Court Diamond Hill Kowloon Hong Kong	Chinese
----------------------------	--	---------

Independent Non-executive Directors

Mr. Tang Kwai Chang (鄧貴彰先生)	Flat A, 21st Floor Block 4 Cavendish Heights 33 Perkins Road Jardine's Lookout Hong Kong	Chinese
--------------------------------	---	---------

Mr. Chow Alexander Yue Nong (周裕農先生)	Flat B, 8th Floor Monticello 48 Kennedy Road Hong Kong	Chinese
---	---	---------

Mr. Wong Man Fai (王文輝先生)	Flat A2, 8th Floor Block A Phoenix Court 34, Broadcast Drive Kowloon Hong Kong	Chinese
-----------------------------	---	---------

DIRECTORS AND PARTIES INVOLVED IN THE GLOBAL OFFERING

For further details regarding our Directors, please refer to the section headed “Directors and Senior Management” in this prospectus.

PARTIES INVOLVED**Sole Global Coordinator**

BOCI Asia Limited
26th Floor, Bank of China Tower
1 Garden Road
Central
Hong Kong

Joint Sponsors

BOCI Asia Limited
26th Floor, Bank of China Tower
1 Garden Road
Central
Hong Kong

BOSC International Company Limited
34th Floor, Champion Tower
3 Garden Road
Central
Hong Kong

**Joint Bookrunners &
Joint Lead Managers**

BOCI Asia Limited
26th Floor, Bank of China Tower
1 Garden Road
Central
Hong Kong

DBS Asia Capital Limited
17th Floor, The Center
99 Queen’s Road Central
Central
Hong Kong

Kingsway Financial Services Group Limited
7/F, Tower One Lippo Centre
89 Queensway
Hong Kong

Future Land Resources Securities Limited
Flat B, 20/F Guangdong Investment Tower
148 Connaught Road Central
Sheung Wan
Hong Kong

DIRECTORS AND PARTIES INVOLVED IN THE GLOBAL OFFERING

	VBG Capital Limited 18/F, Prosperity Tower, 39 Queen's Road Central, Central, Hong Kong
Co-lead Managers	China Galaxy International Securities (Hong Kong) Co., Limited 20/F Wing On Centre 111 Connaught Road Central Hong Kong
	Prestige Securities Limited Suite 5102, Cheung Kong Center 2 Queen's Road Central Hong Kong
	Lego Securities Limited Room 804, 8/F, Jubilee Centre 46 Gloucester Road Wan Chai, Hong Kong
Reporting Accountants	Ernst & Young 22/F CITIC Tower 1 Tim Mei Avenue Central Hong Kong
Legal advisors to our Company	<i>As to Hong Kong laws:</i> Benny Pang & Co 27th Floor, 100 QRC 100 Queen's Road Central Hong Kong
	<i>As to PRC laws:</i> JunHe LLP Suite 2803-04, 28th Floor, Tower Three Kerry Plaza No.1-1, Zhongxinsi Road Futian District Shenzhen, China
	<i>As to Bermuda laws:</i> Appleby 2206-19 Jardine House 1 Connaught Place Central Hong Kong

DIRECTORS AND PARTIES INVOLVED IN THE GLOBAL OFFERING

Legal advisors to the Underwriters	<i>As to Hong Kong laws:</i> Morrison & Foerster 33rd Floor, Edinburgh Tower The Landmark 15 Queen's Road Central Hong Kong <i>As to PRC laws:</i> Jingtian & Gongcheng Suite 45/F K. Wah Centre 1010 Huaihai Road (M) XuHui District, Shanghai 200031 China
Industry consultant	Frost & Sullivan 1706, One Exchange Square 8 Connaught Place Central Hong Kong
Property valuer	Jones Lang LaSalle Corporate Appraisal and Advisory Limited 6/F, Three Pacific Place 1 Queen's Road East Hong Kong
Receiving banks	Bank of China (Hong Kong) Limited 1 Garden Road Hong Kong DBS Bank (Hong Kong) Limited 16/F, The Center 99 Queen's Road Central Central Hong Kong

CORPORATE INFORMATION

Registered office in Bermuda	Canon's Court 22 Victoria Street Hamilton HM 12 Bermuda
Head office and principal place of business in Hong Kong	Flats F-J, 11th Floor, Block 1 Kwai Tak Industrial Centre, 15–33 Kwai Tak Street, Kwai Chung, New Territories Hong Kong
Company's website	<u>www.twcoffee.com</u> <i>(Information on the website does not form part of this prospectus)</i>
Company secretary	Mr. Wu Kam On Keith (<i>HKICPA</i>) Flat D, 6th Floor Tower 18 Mayfair By The Sea I 23 Fo Chun Road Tai Po, New Territories Hong Kong
Authorized representatives	Mr. Wong Tat Tong House H3 Bellevue Place 93 Repulse Bay Road Hong Kong Mr. Wu Kam On Keith Flat D, 6th Floor Tower 18 Mayfair By The Sea I 23 Fo Chun Road Tai Po, New Territories Hong Kong
Audit Committee	Mr. Tang Kwai Chang (<i>Chairman</i>) Mr. Chow Alexander Yue Nong Mr. Wong Man Fai
Nomination Committee	Mr. Chow Alexander Yue Nong (<i>Chairman</i>) Mr. Wong Tat Tong Mr. Wong Man Fai

CORPORATE INFORMATION

Remuneration Committee	Mr. Wong Man Fai (<i>Chairman</i>) Mr. Wong Tat Tong Mr. Tang Kwai Chang
Principal Share Registrar and Transfer Office in Bermuda	Estera Management (Bermuda) Limited Canon's Court 22 Victoria Street Hamilton HM 12 Bermuda
Hong Kong Share Registrar	Tricor Investor Services Limited Level 22 Hopewell Centre 183 Queen's Road East Hong Kong
Compliance advisor	BOSC International Company Limited 34th Floor, Champion Tower 3 Garden Road Central Hong Kong
Principal banks	Bank of China (Hong Kong) Limited Bank of China Tower 1 Garden Road Hong Kong Hang Seng Bank Limited 83 Des Voeux Road Central Hong Kong

INDUSTRY OVERVIEW

The information presented in this section is derived from various official government publications and other publications and from the market research report prepared by Frost & Sullivan which was commissioned by us, unless otherwise indicated. We believe that the sources of such information are appropriate sources for such information and we have taken reasonable care in extracting and reproducing such information. We have no reason to believe that such information is false or misleading in any material respect or that any fact has been omitted that would render such information false or misleading in any material respect. Our Directors confirm that, after taking reasonable care, there is no adverse change in the market information that would qualify, contradict or have a material impact on such information since the date of the Frost & Sullivan Report. The information has not been independently verified by our Company, the Selling Shareholder, the Sole Global Coordinator, the Joint Sponsors, the Joint Lead Managers, the Joint Bookrunners, the Underwriters, any of our or their respective directors, officers or representatives or any other person involved in the Global Offering (other than Frost & Sullivan) and no representation is given as to its accuracy. The information and statistics may not be consistent with other information and statistics compiled within or outside of China.

REPORT COMMISSIONED BY FROST & SULLIVAN

We commissioned Frost & Sullivan, an independent market research and consulting company, to conduct an analysis of, and to report on, the B2B coffee and tea market in Hong Kong, the PRC and Macau, the frozen meat market in Hong Kong and the PRC and the frozen processed food market in Hong Kong and the PRC, for the period from 2012 to 2021. The report we commissioned (the “**Frost & Sullivan Report**”) has been prepared by Frost & Sullivan independently. We agreed to pay Frost & Sullivan a fee of HK\$500,000 for the preparation of the Frost & Sullivan Report. Founded in 1961 in New York, Frost & Sullivan has over 40 global offices with more than 1,800 industry consultants, market research analysts, technology analysts and economists. It offers industry research and market strategies and provides growth consulting and corporate training. Frost & Sullivan has been covering the Chinese market from its offices in the PRC since the 1990’s. Frost & Sullivan has four offices in China and direct access to the most knowledgeable experts and market participants in the food and beverage market and its industry consultants, on average, have more than five years of experience.

The Frost & Sullivan Report includes information on the food and beverage market in Hong Kong, the PRC and Macau and their sub-segments and other market and economic data, which have been quoted in this prospectus. Frost & Sullivan’s independent research was undertaken through both primary and secondary research obtained from various sources within the food and beverage market in Hong Kong, the PRC and Macau. Primary research involved interviewing industry participants and authoritative third party industry associations. Secondary research involved reviewing company annual reports, official bureaus’ databases, independent research reports or journals and Frost & Sullivan proprietary database built up over the past decades. Historical data for market size and competition analysis was obtained both from primary research including top-down interviews with industry participants and from a variety of secondary research. The Frost & Sullivan Report is based on the assumptions that the social, economic and political environments being examined will remain stable during the forecast period, which ensures the sustained development of the B2B coffee and tea products market, the frozen meat market and the frozen processed food market.

OVERVIEW OF THE B2B COFFEE AND TEA PRODUCTS MARKET IN HONG KONG, MACAU AND THE PRC

Coffee and tea are two of the popular beverages in Hong Kong, the PRC and Macau. Tea has been one of the main staples of the Asian diet and coffee’s popularity continues to rise in this region. Driven in part by the economic growth in the aforementioned markets and the increase in consumption expenditures in the relevant markets, the B2B coffee and tea products market in Hong Kong, the PRC and Macau has expanded over the last few years and is expected to continue to grow at a robust pace in the next five years.

INDUSTRY OVERVIEW

The food consumption expenditure in Hong Kong expanded from HK\$197.7 billion in 2012 to HK\$244.5 billion in 2016, representing a CAGR of 5.5% during the period. In Macau, food, beverage and tobacco consumption expenditure increased from MOP6.3 billion in 2012 to MOP9.1 billion in 2016, representing a CAGR of 9.6%. While in the PRC, food, beverage and tobacco consumption expenditure grew from RMB5,245.6 billion in 2012 to RMB7,285.9 billion in 2016, representing a CAGR of 8.6% during the period.

The market expansion has benefited B2B coffee and tea products suppliers and service providers in the region with the ability to provide (i) a one-stop service, (ii) customized products, and (iii) multi-channel distribution. Concerns over food safety and cost control has led commercial customers, such as Cha Chaan Teng, luxury hotels, fast food chains, and restaurants, to purchase food and beverages from suppliers that are capable of providing one-stop service to control the product quality more effectively and to enhance the procurement efficiency. At the same time, there is a growing demand for suppliers with the ability to consistently customize products to cater to changing demands of end customers, and to distribute such products efficiently through its established channels.

Overview of the B2B coffee and tea products market

B2B coffee and tea products market in Hong Kong

Benefiting from Hong Kong's traditional catering culture which combines both local and western diets where coffee as well as tea are common beverages, the B2B coffee and tea products market in Hong Kong has grown steadily between 2012 and 2016 at a CAGR of 4.6%. Sales of B2B coffee and tea products have contributed to the growth rather evenly, with B2B coffee products growing at a CAGR of 4.8% and B2B tea products growing at a CAGR of 4.2% during this period. As a relatively mature market, the B2B coffee and tea products market is expected to rise steadily from HK\$1,363.5 million in 2017 to HK\$1,610.3 million in 2021 at a CAGR of 4.2%, with B2B coffee products and B2B tea products having rather leveled contribution at a CAGR of 4.5% and 3.9%, respectively.

In 2016, black tea was the most popular tea product in Hong Kong's B2B tea products market, with a market share of approximately 61.9% and is projected to grow at a CAGR of 3.4% between 2017 and 2021. Building on its wide application to Hong Kong style milk tea, which is generally produced with black tea and black tea's reputation as a healthy product, it is widely consumed. The chart illustrates the B2B coffee and black tea market size in Hong Kong between 2012 and 2021.

B2B Coffee and Black Tea Market Size in Hong Kong (2012–2021E)

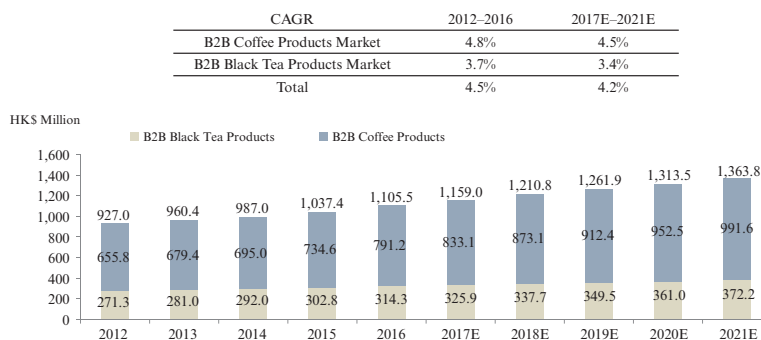

Source: Frost & Sullivan

INDUSTRY OVERVIEW

B2B coffee and tea products market in the PRC

The increase in coffee consumption in the PRC prompted by the influence of western culture and changing consumer preference was a driving force behind the B2B coffee products market growth in the PRC. Between 2012 and 2016, the B2B coffee products market in the PRC doubled while growing at a CAGR of 20.3%. With the increasing popularity of coffee products among new generation consumers, the size of B2B coffee products market in the PRC is expected to continue to grow from RMB5.0 billion in 2017 to RMB8.2 billion in 2021, representing a CAGR of 13.2%. At the same time, the B2B tea products market observed a rapid growth between 2012 and 2016. Going forward, the B2B tea products market in the PRC is expected to expand at a CAGR of 5.3% between 2017 and 2021.

In particular, between 2012 to 2016, the B2B coffee and tea products market in the east China region witnessed a prominent growth at a CAGR of 8.4%, while the south China region grew steadily at a CAGR of 6.7%. It is expected that between 2017 to 2021, the B2B coffee and tea products market in the east and south China regions will grow at a CAGR of 7.5% and 5%.

In the PRC market, the majority of non-Chinese restaurants are sourcing black tea. On the other hand, the majority of Chinese restaurants source white tea, green tea, yellow tea, oolong tea and post-fermented tea. Black tea is becoming increasingly popular in recent years with a market share of approximately 7.8% in 2016, ranking the third among the six types of tea products in the PRC. The charts illustrate the B2B coffee and black tea market size in the PRC, east China region and south China region between 2012 and 2021.

B2B Coffee and Black Tea Market Size in the PRC (2012–2021E)

CAGR	2012–2016	2017E–2021E
B2B Coffee Products Market	20.3%	13.2%
B2B Black Tea Products Market	7.8%	6.4%
Total	15.2%	11.0%

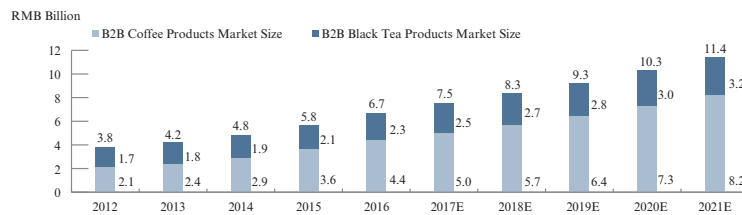

Source: United States Department of Agriculture, General Administration of Customs of the PRC, Frost & Sullivan

B2B Coffee and Tea Market Size in East China Region (2012–2021E)

CAGR	2012–2016	2017E–2021E
B2B Coffee Products Market	22.0%	16.2%
B2B Black Tea Products Market	6.7%	5.5%
Total	8.4%	7.5%

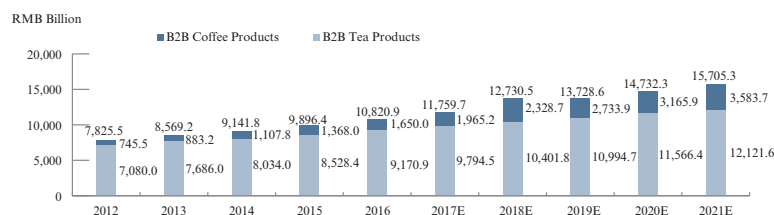

Source: Frost & Sullivan

Note: East China region includes the provinces of Anhui, Fujian, Jiangsu, Jiangxi, Shandong and Zhejiang, as well as the municipality of Shanghai.

INDUSTRY OVERVIEW

B2B Coffee and Tea Market Size in South China Region (2012–2021E)

	CAGR	2012–2016	2017E–2021E
B2B Coffee Products Market	7.8%	7.8%	7.4%
B2B Black Tea Products Market	6.5%	6.5%	4.5%
Total	6.7%	6.7%	5.0%

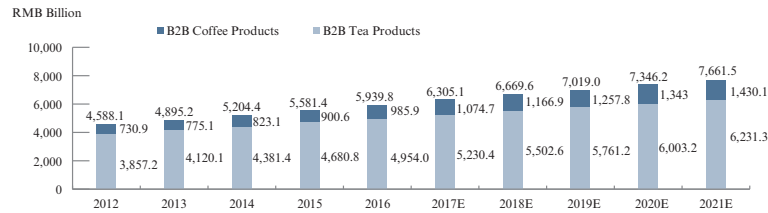

Source: Frost & Sullivan

Note: South China region includes Guangdong, Guangxi, Hainan, Hong Kong and Macau.

B2B coffee and tea products market in Macau

Macau's B2B coffee and tea products market increased from MOP96.2 million in 2012 to MOP123.0 million in 2016, representing a CAGR of 6.3%, as a result of a rise in consumption. As a relatively mature market, it is estimated to steadily rise from MOP128.4 million in 2017 to MOP148.2 million in 2021 with a CAGR of 3.7%. In particular, driven by the increasing popularity of specialty coffee stores in Macau, coupled with the expected recovery of tourism industry, B2B coffee products market is projected to demonstrate a strong growth potential, growing from MOP56.1 million in 2017 to MOP63.2 million with a CAGR of 3.0%. At the same time, the B2B tea market in Macau is expected to grow to MOP85.0 million by 2021, representing a CAGR of 4.1% between 2017 and 2021. The chart below illustrates the B2B coffee and black tea market size in Macau between 2012 and 2021:

B2B Coffee and Black Tea Market Size in Macau (2012–2021E)

	CAGR	2012–2016	2017E–2021E
B2B Coffee Products Market	1.9%	1.9%	3.0%
B2B Black Tea Products Market	20.6%	20.6%	7.9%
Total	4.9%	4.9%	4.2%

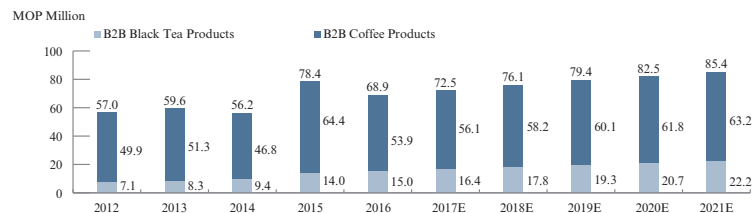

Source: International Trade Center, Frost & Sullivan

Growth drivers of the B2B coffee and tea products market

Catering culture. Coffee and tea are popular and well-accepted beverages in Hong Kong, Macau and the PRC. Tea has long been a staple in the region, and Hong Kong has even developed its own special coffee and milk tea mix-drink, yuan yeung. At the same time, coffee along with western cuisine has also become a main staple and is expected to continue to grow in the near future. In recent years, milk tea has also kept its popularity in Hong Kong.

Fast paced life. Coffee and tea are relied upon by many as a daily refresher. Particularly, in a fast paced work environment, coffee and tea are viewed as essential beverages to many and it is relatively common for offices to prepare coffee or tea products for employees. Such market position is expected to drive the growth of coffee and tea products in the region.

INDUSTRY OVERVIEW

Consumption upgrade. Boutique coffee shops, special tea lounges and food and beverage outlets that allow for a pursuit of exquisite style of life are becoming more popular in the region. Such establishments, with their traditional and elegant atmosphere for consumers to relax while enjoying high-end tea and coffee products are expected to drive the growth of the coffee and tea products market in the region.

Development trends of the B2B coffee and tea products market

Higher demand for customized and one-stop B2B service. Customers from different segments of food and beverage industry usually have specified requirements for their product demands. Food and beverage service providers which cater to the mass market generally require quick turnarounds and are often cost-conscious, while market participants which serve to a niche segment would value the uniqueness of a product. To better serve different types of customers and to further expand its business, B2B coffee and tea products service providers are expected to consistently provide customized services in the future.

Growing popularity of health-oriented food and beverage and environment-friendly products. Consumers are becoming increasingly health-conscious and there is a general trend towards heightened products safety measures and regulations. Such development benefits B2B coffee and tea products providers with a strong track record and the ability to source a wide range of raw materials required for the production of healthy products.

Emerging e-commerce channel. Driven by the growth of e-commerce players in the PRC, online sales are booming in recent years and are expected to become a focus of retailers and brand owners.

Competitive landscape

Hong Kong

The B2B coffee and black tea products market in Hong Kong is relatively concentrated. In 2016, revenue from the top five B2B coffee and black tea products providers in Hong Kong aggregated to HK\$782.1 million, representing a market share of 70.8%. The level of concentration in the Hong Kong market is expected to intensify as a result of an increase in demand for (i) one-stop services; and (ii) reputable suppliers. Such development is expected to benefit large-scale B2B coffee and black tea products providers which could leverage over their wealth of industry knowledge and product know-how, their comprehensive product portfolios and ability to consistently provide customized products and integrated solutions. As one of the few integrated B2B coffee and black tea solutions providers whose distribution networks covers various food establishments, the Group's market knowledge gives it a competitive edge over most of the other participants in the coffee and black tea market. In addition, in 2016, the Group was the largest Sri Lanka tea importer in terms of volume in Hong Kong.

Competitive Landscape of B2B Coffee and Black Tea Market in terms of Revenue in Hong Kong, 2016

Company Name	Market Share %
1 The Group	24.5%
2 Company A	15.9%
3 Company B	11.9%
4 Company C	11.1%
5 Company D	7.4%

Source: Frost & Sullivan

INDUSTRY OVERVIEW

Market Coverage in Hong Kong by Type of Food and Beverage Serving Establishments

The Group had market coverage that can reach approximately 60% of the food and beverage serving establishments in Hong Kong in 2016 with details set out below. Such extensive market coverage gives the Group a unique opportunity to closely collaborate with a comprehensive set of food and beverage service providers and be current with the latest consumer tastes. At the same time, the extensive market coverage also gives the Group a first-mover advantage over its competitors as it is well-positioned to identify new customers and/or market opportunities.

		Market Coverage of the Group (2016) (up to)
Café	Café is a small restaurant serving beverages and light meals.	78.7%
Fast food store	Fast food store is a type of restaurant that serves fast food cuisine and has minimal table service.	77.6%
Cha Chaan Teng	Cha Chaan Teng, which is literally a tea restaurant, is a type of restaurant commonly found in Hong Kong, Macau and parts of Guangdong province in China. They are known for eclectic and affordable menus, which include dishes from Hong Kong cuisine and Hong Kong-style western cuisine.	70.3%
Hotel	Hotels are establishments that provide paid lodging on a short-term basis.	66.7%
Western restaurant	Western restaurants mainly engage in providing food and beverage serving services for consumption on the premises. Typically, customers sit at tables and are served while seated.	65.8%
Other food and beverage establishments	Restaurants serve cuisines other than Chinese and western (such as Japanese restaurants, Thai restaurants), take away shops, stalls at food court, bars and lounges and others.	51.3%
Chinese restaurant	Chinese restaurants include restaurants serving Guangdong cuisine, Beijing cuisine, Sichuan cuisine, Shanghai cuisine, and other Chinese cuisines. Tea products consumed in this kind of restaurants are usually traditional Chinese tea, such as Longjing green tea, Pu-erh tea and jasmine tea.	32.8%

Source: Frost & Sullivan

PRC

The B2B coffee and black tea products market in the PRC is highly fragmented. In 2016, revenue from the top five players of the B2B coffee and black tea products market in the PRC aggregates to RMB990.5 million, representing a market share of 14.8%. As the PRC government enhances its food safety and quality requirements and continues to enforce more stringent industry standards on food and beverage production, there is potential for further market consolidation. Scaled B2B coffee and tea products providers with the resources to meet such elevated industry standard may have the opportunity to consolidate smaller coffee and tea products providers without such means. In addition, a growth in demand for total solution services and the ability to provide customized service at competitive price is expected to benefit large-scale food and beverage supply providers with advanced production capabilities.

INDUSTRY OVERVIEW

**Competitive Landscape of B2B Coffee and Black Tea Market
(In Terms of Revenue and Sales Volume), China, 2016**

	Company Name	Market Share in Revenue %	Market Share in Sales Volume %
1	Company E	6.12%	7.03%
2	Company F	3.84%	2.29%
3	Company A	2.39%	1.67%
4	The Group	1.23%	0.82%
5	Company G	1.20%	1.33%

Source: Frost & Sullivan

The Group was also the third largest importer of Sri Lanka tea in terms of volume in the PRC in 2016. Sri Lanka was the largest black tea exporting country by export value and the second largest by export volume in 2016. The Group's import volume of 69.2 tons in 2016 accounted for 9.2% of the total black tea import market in the PRC.

Macau
**Competitive Landscape B2B Coffee and Black Tea Business
(In Terms of Operating Revenue), Macau, 2016**

	Company Name	Market Share in Operating Revenue
1	Company H	13.90%
2	Company I	10.56%
3	The Group	9.91%
4	Company J	8.78%
5	Company A	6.43%

Source: Frost & Sullivan

The B2B coffee and black tea market in Macau is relatively concentrated. In 2016, revenue from the top five B2B coffee and tea service providers in Macau aggregated to MOP34.2 million, representing a market share of 49.6%. The Group ranked third with an operating revenue of MOP6.8 million, accounting for 9.91% of the total market in 2016.

Entry barriers

Establishment of a business network. New entrants face the challenge of establishing a supply and sales network while competing against established players, and may consequently find it difficult to acquire the necessary resources for further development.

Compliance with food safety control. With increasing awareness of food safety among customers and a tightening regulatory environment in the food and beverage industry, there is a heightened requirement for quality control systems, which in turn, is an entry barrier for many because it is difficult for new entrants to develop such a system within a short period of time. In particular, multi-national corporations have made food safety and quality a top priority in recent years, which is expected to create an entry barrier to small-scale food and beverage suppliers.

Building a brand image. In order to ensure food safety and quality and to differentiate themselves from competitors, business customers generally prefer coffee and tea products with well-known brands that are associated with food safety and quality. Such entry barrier creates a high hurdle for new entrants as it will take time to build brand recognition.

OVERVIEW OF FROZEN MEAT PRODUCTS MARKET IN HONG KONG AND THE PRC
An Introduction to Frozen Meat Products

Frozen meat is a type of product that can be preserved from the time it is prepared to the time it is consumed through special freezing techniques. Freezing is an effective method of food preservation as the elements, that cause food spoilage, are eliminated or slowed at low temperatures. Frozen meat products can be mainly divided by meat types and cooking methods into uncooked roast, uncooked steaks or chops, uncooked ground, uncooked poultry, and cooked meat and poultry.

INDUSTRY OVERVIEW

Overview of Frozen Meat Products Market in Hong Kong and the PRC

Frozen meat products market in Hong Kong

Frozen Meat Market Size in Hong Kong (2012–2021E)

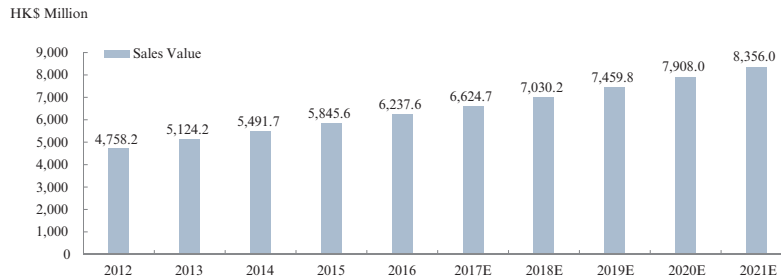

Source: Frost & Sullivan

With a robust demand from food and beverage service industry, the market of frozen meat products has grown steadily at a CAGR of 7.0% between 2012 and 2016. Benefiting from the convenient transportation preservation of frozen meat products, the frozen meat market in Hong Kong is expected to further grow to HK\$8,356.0 million in 2021, representing a CAGR of 6.0% between 2017 and 2021.

Frozen meat products market in the PRC

Frozen Meat Market Size in the PRC (2012–2021E)

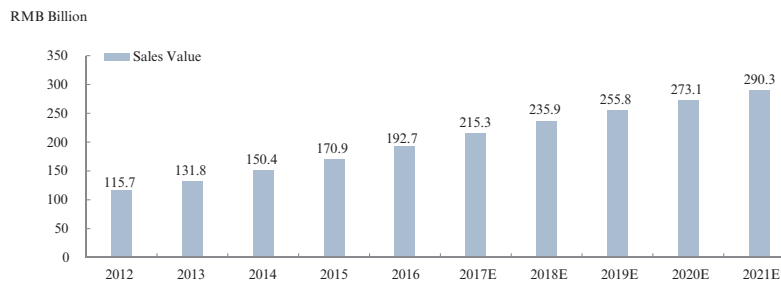

Source: Frost & Sullivan

Alongside the rapid urbanization and a change in lifestyle in the PRC, the demand for frozen meat products grew significantly. In turn, such development contributed to a substantial growth in the frozen meat market over the last few years, reaching RMB192.7 billion in 2016, representing a CAGR of 13.6% between 2012 and 2016. At the same time, the frozen meat market is expected to continue to expand at an expected CAGR of 7.8% between 2017 and 2021, reaching RMB290.3 billion by 2021.

Growth drivers of the frozen meat products market

Convenience of transportation and storage. Compared to fresh meat, frozen meat can be transported conveniently and better preserved. Its transportation and storage convenience ensures qualified food delivery and long product storage duration, which better meets the business needs of the catering industry as the latter emphasizes food safety and durable storage to have smooth business operation and to better serve their customers. At the same time, improvement with cold-chain logistics techniques have also facilitated the transportation of frozen meat and contributed to the growth of frozen meat products market.

Strong demand for imported meat based on price and quality. The demand for imported meat from consumers drives the development of frozen meat market as the majority of such imported products needs to be frozen for global transportation.

Development trends of the frozen meat products market

Stricter requirement over food safety. Customers' expectation on food safety has elevated resulted from (i) the general increase in health awareness, and (ii) new rules and regulations over food safety promulgated by relevant authorities. Meanwhile, the permeating effects of social media also elevated the importance of food safety for frozen meat providers as any quality issue could materially and adversely impact a provider's reputation quickly.

Pursuit for high quality and more diverse products. In line with a heightened awareness of food safety and health-related matters, there is an increase in demand for high quality products, including products from particular regions that are known for its quality. Such development requires frozen meat providers to enhance their sourcing capabilities by

INDUSTRY OVERVIEW

selecting only quality suppliers, which in turn, may require site visits to the sources of origin. Frozen meat suppliers would also be expected to continuously expand its product offering to include a more comprehensive set of quality products.

Increasing demand for imported food products. The growth in middle-class population and the stable increase in the average household disposable income in China enabled more consumers to be able to consume relatively higher priced imported food products. Recent prevailing food safety scandals in the PRC has also led consumers to become more willing to pay for imported food products with safety and high-quality.

Booming demand from young generations. As opposed to the previous generation of consumers, the young consumers in China have grown a habit of purchasing food products that are more convenient and have longer shelf life. Such development benefits the frozen meat products market as it creates more demand for such products.

Competitive landscape for frozen meat products

The frozen meat products market is highly fragmented in both Hong Kong and the PRC. There are over 100 companies focusing on the provision of frozen meat wholesale service in Hong Kong, and while some established market participants have sizable market share in the PRC, the PRC frozen meat products market still houses a large number of individual producers and processors and small-scale frozen meat products workshops.

OVERVIEW OF FROZEN PROCESSED FOOD PRODUCTS MARKET IN HONG KONG AND THE PRC

An Introduction to Frozen Processed Food Products

Frozen processed food refers to food that is partially or completely prepared to optimize ease of consumption. Frozen processed food usually requires minimal preparation, typically heating only, and has a long shelf life. Such food is becoming increasingly popular for the combination of convenient traits it offers. By type of food and processing methods, frozen processed food can be mainly divided into vegetables and fruits, cooked meat and poultry products, cooked seafood products, cooked offal, and dried meat products.

Overview of the Frozen Processed Food Products Market in Hong Kong and the PRC

Frozen processed food products market in Hong Kong

Frozen Processed Food Products Market Size in Hong Kong (2012–2021E)

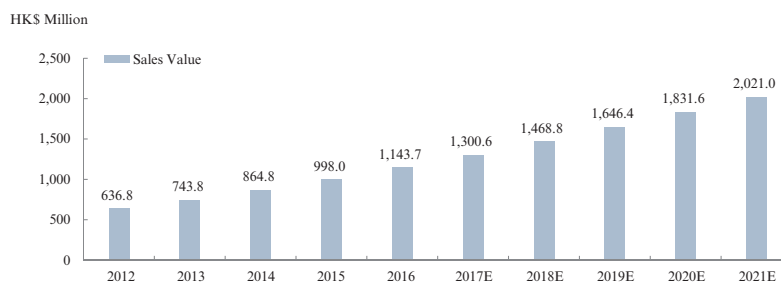

Source: Frost & Sullivan

Frozen processed food market has exhibited strong growth potential in Hong Kong. It grew at a CAGR of 15.8% between 2012 and 2016, and as the industry continues to advance with more customized frozen processed food products for different food services establishments, the frozen processed food market in Hong Kong is expected to further expand from HK\$1,300.6 million in 2017 to HK\$2,021.0 million in 2021 at an expected CAGR of 11.6%.

INDUSTRY OVERVIEW

Frozen processed food products market in the PRC

Frozen Processed Food Market Size in the PRC (2012–2021E)

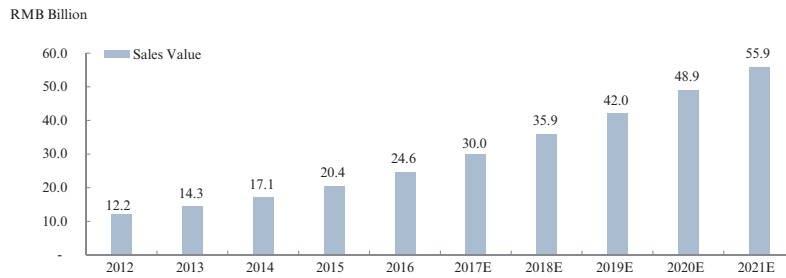

Source: Organization for Economic Co-operation and Development, Frost & Sullivan

The frozen processed food industry has expanded remarkably in the past five years in the PRC. Driven by the growing demand for convenience, the frozen processed food market in the PRC grew at a CAGR of 19.2% between 2012 and 2016. It is expected that further development in the frozen processed food market in China, including an increase in product diversity, leading to an increase from RMB30.0 billion in 2017 to RMB55.9 billion in 2021, representing a CAGR of 16.8%.

Growth drivers of the frozen processed food products market

Urbanization and increasing acceptance amongst consumers. With urbanization comes a rising need for convenient quality food, and the easy-to-process frozen processed food is increasingly popular amongst the urban population. In turn, such factors provide the demand for frozen processed food.

Convenience for food establishments. Frozen processed food can be transported and stored more conveniently compared to fresh raw materials. Thus, it has gained popularity amongst catering service providers. In addition, as the variety of frozen processed food expands, catering service providers have also increased their procurement for such products as a more diversified portfolio of products can better meet the demand of end consumers.

Low penetration rate and attraction to market participants. Compared to other developed market, the frozen processed food industries in Hong Kong and the PRC are both still at an early development stage with a smaller supplier base, less advanced production techniques and under developed cold-chain logistic system used for long distance transportation. The room for expansion attracts incoming market participants.

Development trends of the frozen processed food products market

More emphasis on convenient food preparation. Catering customers from different food and beverage segments require frozen processed food products that can be easily prepared and quickly served. Therefore, frozen processed food products providers are motivated to develop more convenient ready-to-eat type of products.

Introduction of healthy elements into frozen processed food products. Currently, frozen processed food is generally considered as less healthy than freshly-made dishes with lower nutrition level. Such perception creates the demand for frozen processed food products providers to enhance the health value of frozen processed food products. In addition, frozen processed food products providers may be expected to launch high-end products with organic ingredients in the future.

Further improvement over taste and texture. Consumers have elevated their expectations for taste and texture of the frozen processed food served. Therefore, frozen processed food products providers are motivated to develop products with pleasing flavor and enjoyable texture. The long-term goal would be for frozen processed food products to have no obvious taste and/or texture difference from freshly prepared food.

INDUSTRY OVERVIEW

ENTRY BARRIERS TO FROZEN MEAT AND FROZEN PROCESSED FOOD PRODUCTS MARKET

Regulatory barrier. Stricter laws and regulations on food safety issues, coupled with the tightening supervision of food production and distribution due to recent food scandals, require that frozen meat and frozen processed food suppliers establish in-house quality control system to ensure the food products' traceability, safety and security. Suppliers are also asked to provide approvals and certificates from customs authorities for production and/or distribution of meat products. Suppliers who fail to meet such requirements are forced to exit the market.

Business networks barrier. Commercial customers generally procure frozen meat and frozen processed food products from trusted suppliers who have maintained long-term relationship with them. Such market practice creates a significant entry barrier for new entrants and further benefits to existing suppliers with established sales channels and business connections.

Brand barrier. Commercial customers prioritize brand recognition during their procurement process. They tend to purchase from trusted brands, which in turn, is an entry barrier for new market participants.

RAW MATERIALS

The following charts illustrate movement of the major raw material prices relevant to the Group's business.

Average Price of Imported Milk in Hong Kong (2012–2021E)

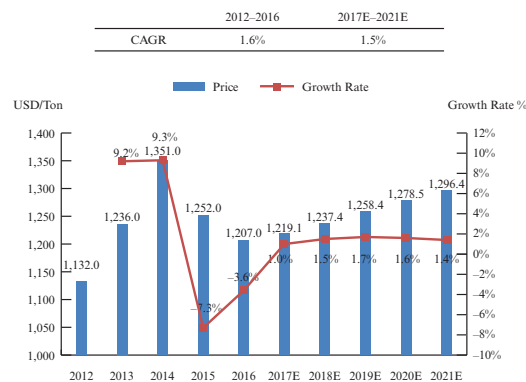

Source: International Trade Center, Frost & Sullivan

Average Price of Imported Coffee Green Bean in Hong Kong (2012–2021E)

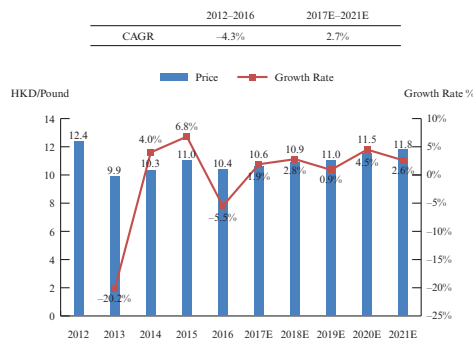

Average Price of Imported Tea from Sri Lanka in Hong Kong (2012–2021E)

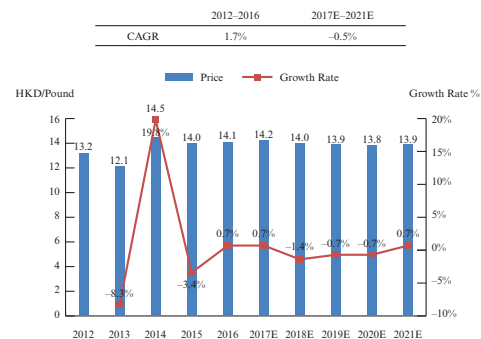

Source: Census & Statistics Department of Hong Kong, International Trade Center, Frost & Sullivan

INDUSTRY OVERVIEW

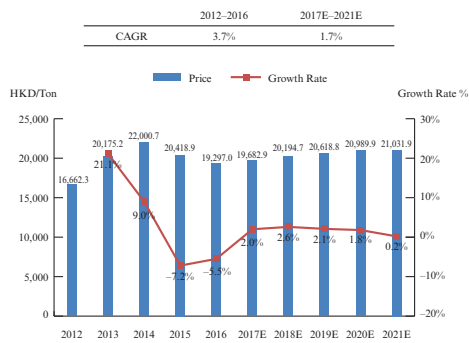
**Average Price of Imported Frozen Meat in Hong Kong
(2012–2021E)**

Source: International Trade Center, Food and Agricultural Organization of the United Nations, Frost & Sullivan

The average price of imported frozen meat in Hong Kong fluctuated during 2012 and 2016 with a CAGR of 3.7%. It first increased from HK\$16,662.3 per ton in 2012 to HK\$22,000.7 per ton in 2014, then the price decreased gradually to HK\$19,297.0 per ton in 2016. This fluctuation was in accordance with the global meat price recorded by the Food and Agricultural Organization of the United Nations as Hong Kong is highly dependent on meat import. Influenced by the expected rising global meat price, the average price of imported meat is projected to witness a slight growth, rising from HK\$19,682.9 per ton in 2017 to HK\$21,031.9 per ton in 2021 with a CAGR of 1.7%.

REGULATORY OVERVIEW

This section sets out a summary of the principal laws and regulations of Hong Kong and the PRC which are most significant and relevant to our business operations in Hong Kong and PRC (but which are not meant to be exhaustive).

OVERVIEW OF HONG KONG LAWS AND REGULATIONS

A. Laws and regulations relating to our business operations

Air Pollution Control Ordinance (Chapter 311 of the Laws of Hong Kong)

The Air Pollution Control Ordinance provides for the setting of air quality objectives for Hong Kong and their implementation through air pollution abatement notices, prosecutions and enforcement.

Under section 30 of the Air Pollution Control Ordinance, the air pollution control authority may service a notice on the owner of the premises in which the chimney, relevant plant or other machinery or equipment is found requiring the owner to modify, repair, clean etc.

Any owner who fails, without reasonable excuse, to comply with any of the requirements in the notice commits an offence and is liable to a fine of HK\$100,000 on conviction for a first offence and HK\$200,000 and imprisonment for 6 months for a second or subsequent offence, and if the offence is a continuing one, to a fine of HK\$20,000 for each day during which it is proved that the offence has continued.

Import and Export Ordinance (Chapter 60 of the Laws of Hong Kong)

The Import and Export Ordinance and the sub-legislations under it regulates the control of, among other things, the import and export of articles into or out of Hong Kong.

Section 6C of the Import and Export Ordinance provides that no one shall import any articles specified in Schedule 1 of the Import and Export (General) Regulations (Chapter 60A of the Laws of Hong Kong) except under and in accordance with an import licence issued by the Director-General of Trade and Industry under section 3 of the Import and Export Ordinance.

Similarly, section 6D of the Import and Export Ordinance provides that no one shall export any articles specified in the second column of Schedule 2 of the Import and Export (General) Regulations (Chapter 60A of the Laws of Hong Kong) except under and in accordance with an export licence issued by the Director-General of Trade and Industry under section 3 of the Import and Export Ordinance.

Under regulations 4 and 5 of the Import and Export (Registration) Regulations (Chapter 60E of the Laws of Hong Kong), every person who imports or exports any articles other than an exempted article shall lodge an accurate and complete import or

REGULATORY OVERVIEW

export declaration relating to such article using services provided by a specified body with the Commissioner of Customs and Excise within 14 days after the importation or exportation of the article.

Any person who is required to lodge an import or export declaration and fails to do so without reasonable excuse (or where there is a reasonable excuse, but the declaration is not lodged as soon as practicable after the cessation of such excuse) shall be guilty of an offence and shall be liable on summary conviction to a fine of HK\$1,000, and, commencing on the day following the date of conviction, to a fine of HK\$100 in respect of every day which such declaration has not been lodged.

Public Health and Municipal Services Ordinance (Chapter 132 of the Laws of Hong Kong)

Under section 52(1), if any person sells to the prejudice of a purchaser any food or drug which is not of the nature, or not of the substance, or not of the quality, of the food or drug demanded by the purchaser, he shall be guilty of an offence. Under Schedule 9, any person who contravenes section 52(1) shall be fined at level 3 (HK\$10,000) and sentenced for 3 months.

Under section 54(1), any person who sells or offers or exposes for sale, or has in his possession for the purpose of sale or preparation for sale, or deposits with, or consigns to, any person for the purpose of sale or of preparation for sale, any food intended for, but unfit for, human consumption shall be guilty of an offence. Under Schedule 9, any person who contravenes section 54(1) shall be fined at level 5 (HK\$50,000) and sentenced for 6 months.

Food Business Regulation (Chapter 132X of the Laws of Hong Kong)

Under section 31(1) of the Food Business Regulation, no person shall carry on or cause, permit or suffer to be carried on food factory business except with a food factory licence.

New applicants who have fulfilled the basic requirements in compliance with the Food Business Regulation may be granted a provisional food factory licence by the Food and Environmental Hygiene Department (“**FEHD**”), pending fulfillment of other outstanding requirements for the issue of a full food factory licence. The validity period for the provisional food factory licence is for a period of 6 months and renewable on one occasion for another period of 6 months. Upon fulfillment of the outstanding requirements and subject to payment of the prescribed licence fee, a full food factory licence, which is valid for a period of 12 months and renewable annually, will be issued.

Any person in contravention of section 31(1) of the Food Business Regulation shall be guilty of an offence and liable to a maximum fine of HK\$50,000 (with an additional daily fine of HK\$900 for a continuing offence) and imprisonment for 6 months.

REGULATORY OVERVIEW

A licence granted under the Food Business Regulation shall be exhibited at a conspicuous place near the entrance of the food factory.

Food Safety Ordinance (Chapter 612 of the Laws of Hong Kong)

Under sections 4 and 5 of Food Safety Ordinance, a person must not carry on the business of food importation or food distribution unless that person is registered as a food importer or food distributor with the Director of Food and Environment Hygiene (“DFEH”). “Food importer” is defined as a person who carries on business that brings or causes to be brought any food into Hong Kong by air, land or water; and “food distributor” is defined as a person who carries on business with the principal activity of supplying food in Hong Kong by wholesale.

Any person who carries on food importation or distribution business without being registered commits an offence and is liable to a maximum fine of HK\$50,000 and imprisonment for 6 months.

Subject to payment of the prescribed fee, the registration granted for food importers and food distributors is valid for a period of 3 years and may be renewed. The DFEH may refuse an application or revoke the registration if the applicant has repeatedly contravened the Food Safety Ordinance in the period of 12 months immediately preceding.

Other than the registration requirement, the Food Safety Ordinance also requires any person who, in the course of business, acquires, imports, captures or supplies food by wholesale to maintain records for the movement of food. The DFEH is empowered to inspect the records, use the records for exercising its powers or performing functions under the Food Safety Ordinance or disclose the records if the DFEH is satisfied that public disclosure of the information is necessary for the protection of public health. Any person who fails to keep records in accordance with the requirements under the Food Safety Ordinance commits an offence and is liable to a maximum fine of HK\$10,000 and imprisonment for 3 months.

Consumer Goods Safety Ordinance (Chapter 456 of the Laws of Hong Kong)

The Consumer Goods Safety Ordinance imposes a duty on manufacturers, importers and suppliers to ensure that the consumer goods supplied complies with the general safety requirements. Thus, no one shall supply, manufacture or import consumer goods unless they comply with the general safety requirements or the approved applicable standard for the particular consumer goods.

Under the Consumer Goods Safety Ordinance, the Commissioner of Customs and Excise is empowered to serve a prohibition notice, prohibiting the supply of consumer goods for a period not exceeding 6 months where the Commissioner believes that the consumer goods do not comply with the approved standard or safety specification established by regulation. The Commissioner may also serve a recall notice requiring the immediate withdrawal and retrieval of the consumer goods where the

REGULATORY OVERVIEW

Commissioner believes the consumer goods do not comply with the approved standard or safety standard or safety regulation established by regulation and there is a risk that the consumer goods will cause a serious injury.

Failure to comply with the general safety requirement, the applicable approved standards or the prohibition or recall notice served constitutes an offence and may be subject to a fine and/or imprisonment.

Factories and Industrial Undertakings Ordinance (Chapter 59 of the Laws of Hong Kong)

The Factories and Industrial Undertakings Ordinance provides for the safety and health protection to workers in an industrial undertaking. Proprietors, being the person having the management or control of the business carried on in such industrial undertaking and also the occupier of any industrial undertaking) are under a duty to ensure, so far as reasonably practicable, the health and safety at work for all persons employed by him at the industrial undertaking. The duties include:

- providing and maintaining plant and work systems that do not endanger safety or health;
- making arrangements for ensuring the safety and health in connection with the use, handling, storage and transport of articles and substances;
- providing information, instruction, training and supervision to ensure the health and safety at work;
- providing and maintaining safe access to and egress from the workplace; and
- providing and maintaining a safe and healthy work environment.

It is an offence for a proprietor to contravene any of the above duties and the proprietor is liable to a fine of HK\$500,000. A proprietor who contravenes these duties willfully and without reasonable excuse commits an offence and is liable to a fine of HK\$500,000 and to imprisonment for 6 months.

Sale of Goods Ordinance (Chapter 26 of the Laws of Hong Kong)

The Sale of Goods Ordinance, which codifies the law in relation to the sale of goods, provides that:

- where there is a contract for sale of goods by description, there is an implied condition that the goods shall correspond with the description;
- where the seller sells goods in the course of business, there is an implied condition that the goods supplied under the contract are of merchantable quality, except that there is no such condition: (a) as regards defects specifically drawn to the buyer's attention before the contract is made; or (b) if the buyer examines the goods before the contract is made, as regards

REGULATORY OVERVIEW

defects which that examination ought to reveal; or (c) if the contract is a contract for sale by sample, as regards defects which would have been apparent on a reasonable examination of the sample; and

- where there is a contract for sale by sample, there is an implied condition that: (a) the bulk shall correspond with the sample in quality; (b) the buyer shall have a reasonable opportunity of comparing the bulk with the sample; and (c) the goods shall be free from any defect, rendering them unmerchantable, which would not be apparent on reasonable examination of the sample.

Subject to the Control of Exemption Clauses Ordinance (Chapter 71 of the laws of Hong Kong), any right, duty or liability arising under a contract of sale of goods by implication of law may be negative or varied by express agreement or by the course of dealing between the parties or by usage if the usage is such as to bind both parties to the contract.

Trade Descriptions Ordinance (Chapter 362 of the Laws of Hong Kong)

Products sold in Hong Kong are subject to the Trade Descriptions Ordinance, which prohibits unfair trade practices used by traders including false trade description, false, misleading or incomplete information, false statements in respect of the goods offered in the course of trade or suppliers of such goods.

“Trade description” (in relation to goods) is defined as an indication, direct or indirect, and by whatever means given, of certain matters including, among other things, quantity, method of manufacture, production, processing or reconditioning, composition, fitness for purpose, compliance with a standard specified or recognized by any person, price, their being of the same kind as goods supplied to a person, place or date of manufacture, production, processing or reconditioning, person by whom manufactured, produced, processed or reconditioned, etc., with respect to the goods. A trade description which is false to a material degree or, though not false, is misleading, that is to say, likely to be taken for a trade description of a kind that would be false to a material degree, is regarded as a false trade description.

Under section 7 of the Trade Descriptions Ordinance, a person commits an offence if, in the course of trade or business, that person applies a false trade description to any goods or supplies or offers to supply any goods to which a false trade description is applied. A person who commits an offence under section 7 of the Trade Descriptions Ordinance shall be subject, on conviction on indictment, to a fine of HK\$500,000 and to imprisonment for 5 years, and on summary conviction, to a fine of HK\$100,000 and to imprisonment for 2 years.

Weights and Measures Ordinance (Chapter 68 of the Laws of Hong Kong)

Under section 16, no person shall in the course of trade supply any goods by weight or measure otherwise than by net weight or measure; and no person shall in the course of trade supply any pre-packed goods by weight or measure unless the net

REGULATORY OVERVIEW

weight or measure of the goods in an authorized unit is legibly marked upon the outside of the container, or upon a label firmly attached thereto, unless the goods are supplied by any sack, bag or other type of container in respect of which a weight in an authorized unit is prescribed. Under section 32, a person who commits an offence under section 16 is liable to a fine of HK\$5,000.

Under section 18(1), no person who supplies goods in the course of trade shall make any statement, whether orally or in writing or otherwise, which he knows to be false or misleading as to a material particular regarding the quantity of the goods supplied.

Under section 21, any person who in the course of trade sells goods in respect of which a warranty may be relied on under section 20 and gives to the purchaser a false warranty commits an offence (unless he shows that he took all reasonable steps to ensure that the statements contained therein were and would continue to be accurate).

Under section 32, a person who commits an offence under sections 18(1) or 21 is liable to a fine of HK\$20,000.

Competition Ordinance (Chapter 619 of the Laws of Hong Kong)

The enactment of the Competition Ordinance which came into force on December 14, 2015 is to prohibit conduct that prevents, restricts or distorts competition in Hong Kong; to prohibit mergers that substantially lessen competition in Hong Kong; and to provide for incidental and connected matters. The Competition Ordinance prohibits restrictions on competition through three rules, namely, the First Conduct Rule, the Second Conduct Rule, and the Merger Rule.

The First Conduct Rule provides that an undertaking must not: (a) make or give effect to an agreement; (b) engage in a concerted practice; or (c) as a member of association of undertakings, make or give effect to a decision of the association, if the object or effect of the agreement, concerted practice or decision is to prevent, restrict or distort competition in Hong Kong. The First Conduct Rule applies to an agreement, concerted practice or decision restricting or distorting competition in Hong Kong even if the agreement or decision is made outside of Hong Kong or any party to the agreement or concerted practice is outside Hong Kong.

The Second Conduct Rule provides that an undertaking that has a substantial degree of market power in a market must not abuse that power by engaging in conduct that has as its object or effect the prevention, restriction or distortion of competition in Hong Kong. Conducts under the Second Conduct Rule may constitute an abuse if it involves predatory behavior towards competitors or limiting production, markets or technical development to the prejudice of consumers. When determining whether an undertaking has a substantial degree of market power in a market, factors which may be taken into account for such determination are the market share of the undertaking, the undertaking's power to make pricing and other decisions and any barriers to entry

REGULATORY OVERVIEW

to competitors into the relevant market. As with the First Conduct Rule, the Second Conduct Rule also applies even if the undertaking engaging in the conduct is outside of Hong Kong or the conduct is engaged in outside of Hong Kong.

Where a person has contravened or been involved in contravention of a competition rule, the Competition Tribunal may impose a pecuniary penalty and make all or any of the orders specified in Schedule 3 of the Competition Ordinance which it considers appropriate, such as, awards of damages, interim injunctions, declare agreements to be void, etc. For conduct that constitutes a single contravention, the amount of pecuniary penalty imposed will be capped at 10% of the turnover of the undertaking concerned for each year in which the contravention occurred, up to a maximum of 3 years.

The Competition Tribunal may also make a disqualification order against the director of a company for a period not exceeding 5 years if it considers that the company of which the person is a director has contravened a competition rule and that the person's conduct as a director makes the person unfit for being involved in the management of the company.

B. Others***Occupational Safety and Health Ordinance (Chapter 509 of the Laws of Hong Kong)***

The Occupational Safety and Health Ordinance provides for the safety and health protection to employees in workplaces in both industrial and non-industrial settings. Under the Occupational Safety and Health Ordinance, employers must, so far as reasonably practicable, ensure the safety and health of all their employees in their workplaces by:

- providing and maintaining plant and work systems that are safe and without risks to health;
- making arrangements to ensure the safety and absence of risk to health in connection with the use, handling, storage or transport of plant or substances;
- providing all necessary information, instruction, training and supervision for ensuring safety and health;
- providing and maintaining safe access to and egress from the workplaces; and
- providing and maintaining a work environment that is safe and without risks to health.

Failure of the employer to comply with the above intentionally, knowingly or recklessly constitutes an offence and is liable to a fine of HK\$200,000 and to imprisonment for 6 months.

REGULATORY OVERVIEW

The Commissioner for Labour is empowered to issue an improvement notice against any failure to comply with the Occupational Safety and Health Ordinance or the Factories and Industrial Undertakings Ordinance or a suspension notice against activity or condition or use of the workplace which may create imminent risk of death or serious bodily injury to employees. Failure to comply with the notices without reasonable excuse constitutes an offence and is liable to a fine of HK\$200,000 and HK\$500,000 respectively and to imprisonment for 12 months. An employer or occupier who knowingly and intentionally continues to contravene the suspension notice will be liable to a further fine of HK\$50,000 for each day.

Occupiers Liability Ordinance (Chapter 314 of the Laws of Hong Kong)

The Occupiers Liability Ordinance regulates the obligations of a person occupying or having control of the premises on injury to persons or damage to goods or other property lawfully on the land.

Under the Occupiers Liability Ordinance, an occupier of the premises is imposed with a “common duty of care” to take such care as in all the circumstances of the case is reasonable to see that the visitor will be reasonably safe in using the premises for the purposes for which he is invited or permitted by the occupier to be there.

Minimum Wage Ordinance (Chapter 608 of the Laws of Hong Kong)

The Minimum Wage Ordinance provides for a prescribed minimum wage at an hourly rate during the wage period for every employee engaged under a contract of employment under the Employment Ordinance (Chapter 57 of the Laws of Hong Kong), save and except for those specified under section 7(2)(3)(4)(5) of the Minimum Wage Ordinance. With effect from May 1, 2017, the statutory minimum wage has been increased to HK\$34.5 per hour. Any provision of the employment contract which purports to extinguish or reduce the right, benefit or protection conferred on the employee by the Minimum Wage Ordinance is void.

Mandatory Provident Fund Schemes Ordinance (Chapter 485 of the Laws of Hong Kong)

Pursuant to the Mandatory Provident Fund Schemes Ordinance, employers shall enroll their employees (between the ages 18 to 65) in a Mandatory Provident Fund Scheme (“**MPF Scheme**”) within the first 60 days of employment. The MPF Scheme is a defined contribution retirement scheme managed by independent trustees. Subject to the minimum and maximum relevant income levels, it is mandatory for both employers and their employees to contribute 5% of the employee’s relevant income to the MPF Scheme. Currently, the minimum and maximum relevant income levels for employees who are paid monthly are HK\$7,100 and HK\$30,000 respectively.

REGULATORY OVERVIEW

OVERVIEW OF PRC LAWS AND REGULATIONS

A summary of the main PRC laws, rules and regulations applicable to our current business and operations is set out below.

Policies Relating to Foreign Investment

Guidance on foreign investment in different industries in the PRC can be found in the Foreign Investment Industrial Guidance Catalogue 《外商投資產業指導目錄》 (the “**Catalogue**”) jointly issued by NDRC and MOFCOM and such Catalogue will be amended and re-promulgated from time to time by these two government authorities. Industries generally fall into four categories for the purposes of guiding foreign investment: the encouraged, permitted, restricted and prohibited categories. The Catalogue only lists out specific industries falling under the encouraged, restricted and prohibited categories and what is not listed there would fall into the permitted category. The current effective version of the Catalogue was issued on June 28, 2017 and became effective on July 28, 2017 (the “**2017 Catalogue**”). According to the 2017 Catalogue, the business activities conducted by the subsidiaries of our Company established in the PRC should belong to the encouraged category.

Laws and Regulations Relating to the Food Industry

Food Safety in General

The Food Safety Law of the PRC 《中華人民共和國食品安全法》 (the “**Food Safety Law**”), which was amended by the Standing Committee of the National People’s Congress (the “**NPCSC**”) on April 24, 2015 and became effective on October 1, 2015, and its implementation regulation 《中華人民共和國食品安全法實施條例》, which was promulgated by the State Council, became effective on July 20, 2009, and amended on February 6, 2016, adopt the measures and requirements in the following aspects to improve food safety and prevent large scale food safety accidents:

- strengthening the role of local governments in the supervision and coordination of food safety regulation work
- strengthening food safety risk monitoring and assessment; early intervention and quick control over food safety accidents
- revising the standards for the use of food additives and strengthening regulations on the use of food additives
- establishing a food recall system
- abolishing food safety inspection exemption system
- clarifying the fundamental principles in formulating food safety standards

REGULATORY OVERVIEW

Food Production Permit

According to the Food Safety Law, the state shall adopt a licensing system for food production and trade. Those intending to operate in the production or sale of food or the catering services shall legally obtain a permit.

According to the Measures for the Administration of Food Production Licences 《食品生產許可管理辦法》, which was promulgated by CFDA on August 31, 2015, became effective on October 1, 2015 and was amended on November 17, 2017, CFDA shall take charge of the supervision over and guidance to the nationwide food production licensing administration; and local food and drug regulatory authorities at and above the county level shall take charge of food production licensing within their respective administrative regions. Entities and/or individuals engaging in the production of food shall obtain a food production licence. Applicants applying for a food production licence shall meet various conditions set out in the Measures for the Administration of Food Production Licences. The licence is issued by food and drug administration at or above the county level and is valid for five years. The production permit obtained before the Measures for the Administration of Food Production Licences becoming effective shall still be valid during its period of validity.

Food Operation Permit

According to the Measures for the Administration of Food Operation Licences 《食品經營許可管理辦法》, which was promulgated by CFDA on August 31, 2015, became effective on October 1, 2015 and amended on November 17, 2017, entities and/or individuals engaging in the operation of food shall obtain a food operation licence. Applicants applying for a food operation licence shall meet various conditions set out in the Measures for the Administration of Food Operation Licences.

The licence is issued by food and drug administration at or above the county level and is valid for five years.

According to the Circular of CFDA Regarding the Implementation of the Measures for the Administration of Food Operation Licences 《食品藥品監管總局關於貫徹實施〈食品經營許可管理辦法〉的通知》, which was promulgated by CFDA and became effective on September 30, 2015, Food Circulation Certificate (食品流通許可證) and Catering Service License (餐飲服務許可證) obtained before the Measures for the Administration of Food Operation Licences becoming effective shall still be valid during its period of validity.

Food Inspection

In accordance with the Food Safety Law, the PRC has implemented an inspection system relating to food production and operation. The food and drug supervision and administration departments at and above the county level shall carry out food inspection by taking samples on a regular or irregular basis and may not exempt any food from inspection. An enterprise engaging in the production or operation of food may itself inspect the food it produces, or entrust a qualified food inspection institution to undertake with the inspection.

REGULATORY OVERVIEW

Food Recall System

The PRC has established a food recall system under the requirements of the Food Safety Law.

Pursuant to the Provisions on the Administrative Measures for Food Recalls 《食品召回管理辦法》, which was promulgated by CFDA on March 11, 2015 and became effective on September 1, 2015, food recall is categorised into three grades, namely grade one recall, grade two recall and grade three recall, based on the severity and urgency level of food safety hazards that have been or may be caused. Food will be recalled on two bases: voluntary recall or recall by order.

Laws on Product Quality

The Product Quality Law of the PRC

Products that we manufacture are subject to the laws, rules and regulations in relation to the product quality in the PRC. The Product Quality Law of the PRC 《中華人民共和國產品質量法》 (the “**Product Quality Law**”), which was promulgated by NPCSC on February 22, 1993, became effective on September 1, 1993 and amended on August 27, 2009, is the principal law governing the supervision and administration of product quality.

According to the Product Quality Law, manufacturers are liable for the quality of products they produce and sellers must take reasonable actions to ensure the quality of the products they sell.

A manufacturer shall be liable to compensate for any bodily harm or damage to property (other than the defective product itself) caused by the defective product of the manufacturer unless the manufacturer is able to prove that:

- it has not circulated the product;
- the defect did not exist at the time when the product was circulated; or
- the state of scientific or technological knowledge at the time when the product was circulated was not such that it allowed the defect to be discovered.

The seller shall be liable to compensate for any bodily harm or damage to property (other than the defective product itself) caused by the defective product it sold if such defect is attributable to the seller. A person who is harmed or whose property is damaged by the defective product may claim such loss against the manufacturer or the seller.

Laws on Products Standardization

The Standardization Law of the PRC 《中華人民共和國標準化法》, which was promulgated by NPCSC on December 29, 1988, became effective on April 1, 1989 and amended on November 4, 2017 and the Regulations for the Implementation of the Standardization Law of the PRC 《中華人民共和國標準化法實施條例》 (the “**Standardization Law and Regulations**”) promulgated and implemented on April 6, 1990,

REGULATORY OVERVIEW

formed the legal framework for the development of standard directives and their applications of agricultural, industrial, and service sectors as well as social undertakings and other fields. The tasks of standardization work include the formulation of standards, the implementation of the standards and the supervision over the implementation of the standards.

Standards include national standards, trade standards, local standards, group standards, and enterprise standards. National standards are classified into compulsory standards and voluntary standards, while trade standards and local standards are voluntary standards. Those standards created for protecting human health and life and property safety, maintaining national security and environmental safety, and meeting the basic needs of economic and social administration shall be compulsory standards.

According to the Standardization Law and Regulations, except as otherwise stipulated by laws and regulations, the following standards are in the compulsory category:

1. standards for food hygiene;
2. safety and hygiene standards for products and the production, storage and transportation and utilization of products; standards for the safety of labour and hygiene standards and safety standards for transportation; and
3. quality, safety and sanitation standards for project construction and other standards for project construction that must be controlled by the government.

Enterprises producing, selling or importing products or providing services that fail to meet the compulsory standards shall be investigated and punished in accordance with the Product Quality Law and other laws and regulations, which shall be recorded in the credit record. Criminal liabilities may also be imposed for serious breach of the Standardization Law and Regulations. Standard certificates obtained by enterprises which are in serious breach of the Standardization Law and Regulations may be revoked.

Laws on Product Liabilities

Pursuant to the General Provisions of the Civil Law of the PRC 《中華人民共和國民法總則》, which was promulgated by the National People's Congress and became effective on October 1, 2017 and the Law on the Protection of Consumers' Rights and Interests of the PRC 《中華人民共和國消費者權益保護法》, which was promulgated by the NPCSC on October 31, 1993, became effective on January 1, 1994 and was amended on October 25, 2013, both manufacturers and distributors shall be held jointly liable for the losses and damage suffered by consumers caused by the defective product they manufacture or distribute.

The Tort Liability Law of the PRC 《中華人民共和國侵權責任法》, which was promulgated by the NPCSC on December 26, 2009 and became effective on July 1, 2010, provides that where a product endangers personal life or property due to its defect, the manufacturers and the distributors shall bear the liability in tort.

REGULATORY OVERVIEW

LAWS AND REGULATIONS RELATING TO THE TAXATION**EIT**

According to EIT Law and the EIT Rules, enterprises are divided into resident enterprises and non-resident enterprises. A resident enterprise shall pay EIT on its income deriving from both inside and outside the PRC at the rate of EIT of 25%. A non-resident enterprise that has an establishment or place of business in the PRC shall pay EIT on its income deriving from inside the PRC and obtained by such establishment or place of business, and on its income which derives from outside the PRC but has actual relationship with such establishment or place of business, at the rate of EIT of 25%. A non-resident enterprise that does not have an establishment or place of business in the PRC, or has an establishment or place of business in the PRC but the income has no actual relationship with such establishment or place of business, shall pay EIT on its income deriving from inside the PRC at the reduced rate of EIT of 10%.

Value-added Tax (“VAT”)

Pursuant to the Provisional Regulations on Value-added Tax of the PRC 《中華人民共和國增值稅暫行條例》 (the “**VAT Regulations**”), which was promulgated by State Council on December 13, 1993, became effective on January 1, 1994 and was amended respectively on November 10, 2008, February 6, 2016 and November 19, 2017, and its implementation rules 《中華人民共和國增值稅暫行條例實施細則》, which were amended by MOF on October 28, 2011, entities or individuals engaging in sale of goods, provision of processing services, repairs and replacement services or importation of goods within the territory of the PRC shall pay VAT. Unless provided otherwise, the rate of the VAT is 17%.

LAWS AND REGULATIONS RELATING TO DIVIDEND DISTRIBUTION

Under the Company Law of the PRC 《中華人民共和國公司法》 which was amended by NPCSC on December 28, 2013 and the Law of the PRC on Wholly Foreign-Owned Enterprises 《中華人民共和國外資企業法》 (the “**Wholly Foreign-Owned Enterprises Law**”), which was amended by NPCSC on September 3, 2016, foreign-invested enterprises may not distribute after-tax profits unless they have contributed to the funds as required by PRC laws and regulations and have set off financial losses of previous accounting years.

According to the EIT Law and the relevant implementation rules, dividends paid to its foreign investors are subject to a withholding tax rate of 10%, unless relevant tax agreements entered into by the PRC government provide otherwise.

The PRC government and the government of Hong Kong entered into the Arrangement between Mainland China and Hong Kong for the Avoidance of Double Taxation and the Prevention of Fiscal Evasion with respect to Taxes on Income 《內地和香港特別行政區關於對所得避免雙重徵稅和防止偷漏稅的安排》 (the “**PRC-HK Tax Arrangement**”) on August 21, 2006. According to the PRC-HK Tax Arrangement, the withholding tax rate on dividends

REGULATORY OVERVIEW

paid by a PRC resident enterprise to a Hong Kong resident is 5%, provided that such Hong Kong resident directly holds at least 25% of the equity interests in the PRC resident enterprise. Otherwise, the withholding tax rate is 10%.

Pursuant to the Notice of the PRC State Administration of Taxation on Issues concerning the Application of the Dividend Clauses in Tax Agreements 《國家稅務總局關於執行稅收協定股息條款有關問題的通知》, which was promulgated by SAT on February 20, 2009 and became effective on the same day, all of the following requirements shall be satisfied where a fiscal resident of the other party to a tax agreement needs to be entitled to such tax agreement treatment as being taxed at a tax rate specified in the tax agreement for the dividends paid to it by a PRC resident enterprise: (i) such a fiscal resident who obtains dividends should be a company as provided in the tax agreement; (ii) owner's equity interests and voting shares of the PRC resident enterprise directly owned by such a fiscal resident reaches a specified percentage; and (iii) the equity interests of the PRC resident enterprise directly owned by such a fiscal resident, at any time during the 12 months prior to the obtainment of the dividends, reach a percentage specified in the tax agreement.

According to the Announcement of the State Administration of Taxation on Issues concerning “Beneficial Owners” in Tax Treaties (《國家稅務總局關於稅收協定中“受益所有人”有關問題的公告》) which was promulgated by SAT on February 3, 2018, and the Measures for the Administration of Non-Resident Taxpayers’ Enjoyment of the Treatment under Tax Agreements 《非居民納稅人享受稅收協定待遇管理辦法》 (the “**Administrative Measures**”), which was promulgated by SAT on August 27, 2015 and became effective on November 1, 2015, any non-resident taxpayer meeting conditions for enjoying the convention treatment may be entitled to the convention treatment itself/himself when filing a tax return or making a withholding declaration through a withholding agent, subject to the subsequent administration by the tax authorities.

LAWS AND REGULATIONS RELATING TO ENVIRONMENTAL PROTECTION

The Environmental Protection Law of the PRC 《中華人民共和國環境保護法》 (the “**Environmental Protection Law**”), which was promulgated by National People’s Congress on December 26, 1989, became effective on the same day and was amended by NPCSC on April 24, 2014, establishes the legal framework for the environmental protection in the PRC. The environmental protection department of the State Council supervises and administers the environmental protection work in the PRC, and establishes national standards for the environmental quality and discharge of pollutants. Local environmental protection bureaus are in turn responsible for the environmental protection work within their respective jurisdictions.

Prevention and Control of Pollutions

The Law of the PRC on Prevention and Control of Water Pollution 《中華人民共和國水污染防治法》, which was promulgated by National People’s Congress on May 11, 1984, became effective on November 1, 1984 and was amended by NPCSC respectively on May 15, 1996, February 28, 2008 and June 27, 2017, the Law of the PRC on Prevention and Control of Atmospheric Pollution 《中華人民共和國大氣污染防治法》, which was promulgated by National People’s Congress on September 5, 1987, became effective on

REGULATORY OVERVIEW

June 1, 1988 and was amended by NPCSC respectively on August 29, 1995, April 29, 2000 and August 29, 2015, and the Law of the PRC on Prevention and Control of Environmental Noise Pollution 《中華人民共和國環境噪聲污染防治法》, which was promulgated by NPCSC on October 29, 1996 and became effective on March 1, 1997, as well as the Law of the PRC on the Prevention and Control of Environmental Pollution by Solid Wastes 《中華人民共和國固體廢物污染環境防治法》, which was promulgated by National People's Congress on October 30, 1995, became effective on April 1, 1996 and was amended by NPCSC respectively on December 29, 2004, June 29, 2013, April 24, 2015 and November 7, 2016, prescribe the details for the prevention and control of water pollution, atmospheric pollution, noise pollution and solid waste pollution.

Construction Project Environmental Protection

The Environmental Impact Appraisal Law 《中華人民共和國環境影響評價法》, which was promulgated by NPCSC on October 28, 2002, amended on July 2, 2016 and became effective on September 1, 2016, the Regulations on the Administration of Construction Project Environmental Protection 《建設項目環境保護管理條例》, which was promulgated and became effective by the State Council on November 29, 1998 and amended on July 16, 2017, and the Interim Measures for the Acceptance Inspections of Environment Protection Facilities of Construction Projects 《建設項目竣工環境保護驗收暫行辦法》, which was promulgated by the Ministry of Environmental Protection of the PRC (中華人民共和國環境保護部), require enterprises that are planning construction projects to provide assessment reports, statement or registration form on the environmental impact of such projects. The assessment reports and statements must be approved by the competent environmental protection authorities prior to commencement of any construction work, while the registration forms shall be filed to them. Unless otherwise stipulated by laws and regulations, enterprises which are required to provide assessment reports and statements shall undertake the responsibility of acceptance inspections of the environmental protection facilities by itself upon the completion of the construction project. A construction project may be formally put into production or use only if the corresponding environmental protection facilities have passed the acceptance examination. The competent authorities may carry out spot check and supervision on the implementation of the environmental protection facilities.

LAWS AND REGULATIONS RELATING TO LABOUR

Employment Contracts

The Labour Contract Law of the PRC 《中華人民共和國勞動合同法》 (the “**Labour Contract Law**”), which was promulgated by NPCSC on June 29, 2007 and became effective on January 1, 2008 and whose amendments were made on December 28, 2012, governs the relationship between employers and employees and provides for specific provisions in relation to the terms and conditions of an employment contract. The Labour Contract Law stipulates that employment contracts must be in writing and signed. It imposes more stringent requirements on employers in relation to entering into fixed-term employment contracts, hiring of temporary employees and dismissal of employees.

REGULATORY OVERVIEW

Employee Social Insurance and Housing Provident Funds

Under applicable PRC laws and regulations, including the Social Insurance Law of the PRC 《中華人民共和國社會保險法》, which was promulgated by NPCSC on October 28, 2010 and became effective on July 1, 2011, and the Regulations on the Administration of Housing Provident Fund 《住房公積金管理條例》, which was promulgated by the State Council on April 3, 1999, became effective on the same day and was amended on March 24, 2002, employers and/or employees (as the case may be) are required to contribute to a number of social security funds, including funds for basic pension insurance, unemployment insurance, basic medical insurance, occupational injury insurance, maternity leave insurance, and to housing provident funds. These payments are made to local administrative authorities and employers who fail to contribute may be fined and ordered to rectify within a stipulated time limit.

LAWS AND REGULATIONS RELATING TO PRODUCTION SAFETY

The Production Safety Law of the PRC 《中華人民共和國安全生產法》 (the “**Production Safety Law**”), which was promulgated by NPCSC on June 29, 2002, became effective on November 1, 2002 and was amended on August 31, 2014, is the principal law governing the supervision and administration of production safety in the PRC. This law requires production entities to meet the relevant legal requirements, such as providing its staff with training and a handbook on production safety and providing safe working conditions in compliance with relevant laws, rules and regulations. Any production entities unable to provide the required safe working conditions may not engage in production activities. Violation of the Production Safety Law may result in the imposition of fines and penalties, the suspension of operations, an order to cease operations, or even criminal liability in severe cases.

LAWS AND REGULATIONS RELATING TO FOREIGN-INVESTED ENTERPRISES

The establishment and change of a wholly foreign-owned enterprise (“**WFOE**”), unless WFOE approved by the state to adopt the special access management measures, shall be subject to the record-filing administrative measures as stipulated under Articles 6, 10 and 20 of the Wholly Foreign-Owned Enterprises Law.

The Interim Administrative Measures for the Record-filing of the Incorporation and Change of Foreign-invested Enterprises 《外商投資企業設立及變更備案管理暫行辦法》 (the “**Record-filing Interim Administrative Measures**”) was promulgated on October 8, 2016 and amended on July 30, 2017 by MOFCOM. According to the Record-filing Interim Administrative Measures, the designated representatives or entrusted agents of a foreign-invested enterprise that should be put on record, in the case of the change matters provided in the Record-filing Interim Administrative Measures, shall fill in online and submit an Application for Record-filing of the Change of Foreign-invested Enterprises (外商投資企業變更備案申報表) and the relevant documents via the comprehensive administration system within 30 days upon the occurrence of the change to initiate the record-filing procedures.

REGULATORY OVERVIEW

LAWS AND REGULATIONS RELATING TO FOREIGN CURRENCY EXCHANGE

The principal regulations governing foreign currency exchange in the PRC are the Foreign Exchange Administration Rules of the PRC 《中華人民共和國外匯管理條例》 (the “**Foreign Exchange Administration Rules**”), which were last amended and promulgated on August 5, 2008 and took effect from the same date. Under these rules, international payment and transfer of foreign exchange under current accounts shall not be restricted. The foreign exchange income of a domestic institution or individual may be transferred back into the PRC or deposited overseas. Payment and receipt of foreign exchange under current accounts shall be based on true and legal transactions. Foreign exchange and foreign exchange settlement funds under capital accounts shall be used for the purposes approved by the competent authority and foreign exchange administrative department. Foreign institutions or individuals conducting direct investment in the PRC shall register with the foreign exchange administrative department after obtaining the approval from the competent authority. Domestic institutions or individuals conducting direct investment overseas or issuing or trading marketable securities or derivative products overseas shall complete the registration according to the requirements of the foreign exchange administration under the State Council.

According to the Wholly Foreign-Owned Enterprises Law and its implementation rules, WFOEs shall open bank accounts with the Bank of China or a bank designated by SAFE. Foreign exchange income of a WFOE shall be deposited to the foreign exchange account at the bank it has opened the account with and foreign exchange expenses shall be paid by the foreign exchange account. Foreign investors may remit abroad their legitimate profit, other lawful incomes and liquidated funds received from WFOEs.

INTELLECTUAL PROPERTY LAWS AND REGULATIONS

The PRC has adopted legislations related to intellectual property rights, including trademarks. The PRC is a signatory party to major intellectual property conventions, including the Paris Convention for the Protection of Industrial Property and the Madrid Agreement on the International Registration of Marks and Madrid Protocol.

Regulations on Trademarks

The Trademark Law of the PRC 《中華人民共和國商標法》 (the “**Trademark Law**”) was promulgated in August 1982 (and amended on February 22, 1993, October 27, 2001 and August 30, 2013, respectively), and the Implementation Regulations on the Trademark Law of the PRC 《中華人民共和國商標法實施條例》 were promulgated on August 3, 2002 by the State Council and were amended on April 29, 2014. These laws and regulations provide the basic legal framework for the regulations of trademarks in the PRC. In the PRC, registered trademarks include commodity trademarks, service trademarks, collective marks and certificate marks. The Trademark Office under the State Administration for Industry and Commerce is responsible for the registration and administration of trademarks throughout the country. Trademarks are granted on a term of ten years. Twelve months prior to the expiration of the ten-year term, an applicant can renew the application and reapply for trademark protection. If the registrant fails to apply in a timely manner, a grace period of six additional months may be granted. Within one year from the time where a registered

REGULATORY OVERVIEW

trademark is cancelled or declared invalid, or is not renewed upon the expiry of its validity period, the Trademark Office under the State Administration for Industry and Commerce will not approve any application for registration of a trademark identical with or similar to the trademark in question.

Under the Trademark Law, any of the following acts may be regarded as an infringement of the exclusive right to use of a registered trademark:

- use of a trademark that is identical with or similar to a registered trademark on the same or similar kind of commodities without the authorization of the trademark registrant;
- sale of commodities infringing upon the exclusive right to use the registered trademark;
- counterfeiting or making, without authorization, representations of a registered trademark, or sale of such representation of a registered trademark;
- replacing the trademark and reselling the products without the consent of the registrant of the replaced trademark;
- providing conveniences to help others to infringe the exclusive rights to use the registered trademark on purpose; and
- creating other damages to others' exclusive rights to use the registered trademarks.

Violation of the Trademark Law may result in the imposition of fines, confiscation and destruction of the infringing commodities. Trademark licensing agreements must be filed with the Trademark Office under the State Administration for Industry and Commerce or its regional counterparts. The licensor shall supervise the quality of the commodities on which the trademark is used, and the licensee shall guarantee the quality of such commodities.

HISTORY, DEVELOPMENT AND CORPORATE STRUCTURE

HISTORY AND BUSINESS DEVELOPMENT**Introduction**

Our Group was founded by Wong Keu (“**Founder**”), the grandfather of Mr. Wong, in the early 1930s with the business trading principally as a wholesaler in the supply of coffee and tea products, which was then incorporated in 1956 as TWHK.

In 1963, our Group acquired our first factory located in Beech Street, Kowloon for roasting and packaging coffee products. In the 1980s, under the leadership of Mr. Wong, our Group determined to specialize our business in coffee and tea processing and trading with our extensive marketing towards the hotels and fast food chains in Hong Kong. In 1980, our Group acquired and relocated to our present factory in Kwai Tak Industrial Centre in Kwai Chung, New Territories. In 1982, we installed a computerized coffee processing line with automated system, which allowed us to increase our production efficiency. In addition, our Group established alliances with well-established local supermarket chains and convenience stores in Hong Kong for our domestic retail coffee business in Hong Kong.

In the 1990s, in view of the great potential market and business opportunities coming along the social and economic reform in the PRC, our Group extended our presence to the PRC with the aim of capturing the domestic needs of the PRC. In May 1994, we set up ZHTW under the laws of the PRC which carried out coffee processing, including the roasting of coffee beans and the packaging of All-In-One Beverage Mix products, blended tea products and catering supply business.

In the 2000s, with China’s accession to the World Trade Organisation, our Group also benefited from the economic growth of China, particularly in the Pearl River Delta area. In order to utilize the growing logistic network and to capture the opportunities in the PRC market, DGTW was incorporated in 2009, which marked our establishment of the existing integrated production and service centre in Dongguan, the PRC.

In order to enhance our corporate profile, increase the liquidity of our Shares, bring in strategic partner to our Group and expand sources of funding for our then expansion plans, our Company was incorporated on June 13, 2000 under the laws of Bermuda as an exempted company with limited liability for the purpose of listing on the SGX-ST and we were subsequently listed on the SGX-ST on December 14, 2001. On October 3, 2013, our Company was delisted from the SGX-ST for the reasons stated in the paragraph headed “Delisting from SGX-ST” below.

HISTORY, DEVELOPMENT AND CORPORATE STRUCTURE

With a vision to diversify the business profile of our Group and seeing the potential in food market, in January 2013, Whole Sun was incorporated for the purpose of the acquisition of the business and assets of Oriole Properties Limited as part of our plan to commence business in the frozen food business. Details relating to the corporate development of Whole Sun are set out in the paragraph headed “Our Corporate Development — (a) Major subsidiaries of TWIC — Whole Sun” below. Our Group has been continuously expanding our business in frozen food market via local and global cooperation so as to increase our product variety. We started to sell frozen processed food in Hong Kong and the PRC in 2015 and 2016, respectively. In July 2017, our Company entered into a strategic cooperation agreement with NH Foods for the sale of frozen, fresh, pre-cooked processed meat and seafood products. In April 2018, our Company entered into a memorandum of understanding with F&N to explore business and product development opportunities for the supply, distribution, co-branded promotion and co-development of beverage products and/or beverage solutions.

As of the Latest Practicable Date, our Company was wholly-owned by Mr. Wong through an investment holding company, Hero Valour. Our Company holds three wholly-owned intermediate subsidiaries, namely TWIC, TWCH and Great Guarder. TWIC mainly holds our subsidiaries incorporated in Hong Kong with principal businesses conducted in Hong Kong, whilst TWCH mainly holds our subsidiaries established in the PRC with principal businesses conducted in the PRC. Great Guarder holds an investment holding company, namely TWCC.

HISTORY, DEVELOPMENT AND CORPORATE STRUCTURE

The following chart sets forth our Group's corporate and shareholding structure before completion of the Global Offering:

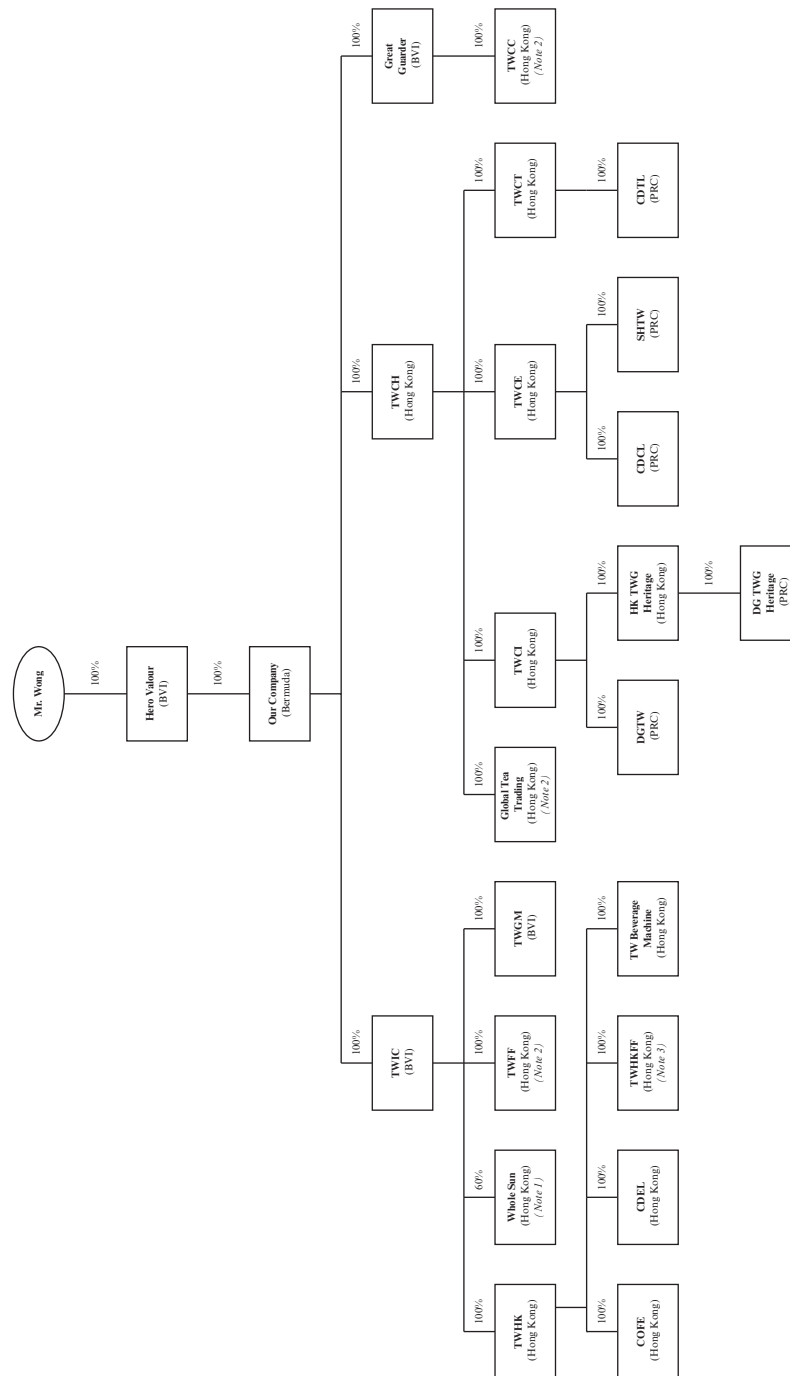

Note 1: The remaining 40% is held as to 20% by Mr. Chu Sun Chi and 20% by Ms. Fan Yin Fun, the spouse of Mr. Chu Sun Chi.

Note 2: TWFF, Global Tea Trading and TWCC are under the process of deregistration as of the Latest Practicable Date.

Note 3: TWHKFF had no business operations as of the Latest Practicable Date.

HISTORY, DEVELOPMENT AND CORPORATE STRUCTURE

Our Approach to Corporate Social Responsibility

Our Group manages corporate social responsibility alongside our business operation, as it is not only our responsibility but also an opportunity for us to achieve long-term business competitiveness. Having been rooted in Hong Kong for 85 years, our Group strives to fulfill our responsibilities as the community's corporate citizen. To address the needs of society through community services, we actively encourage employees' involvement in social contribution activities. Since 2009, our Group has been continuously participating in and initiating various fund raising events. Our Group pays particular care to the elderly and young generations. For instance, we organized the home-cleaning scheme and local tour event for the elderly who live alone for years and provided job shadowing for students. Our Group seeks to bring positive impact to society with our caring commitment. As a recognition from our community, we were awarded with "Caring Company" by the Hong Kong Council of Social Service consecutively for nine years. Our Group regularly reviews and will keep such practice to review our performance and ensure that our corporate social responsibility approach stays correlated to our operational growth and community development.

Milestones in Our Business Development

Year	Event
1932	<ul style="list-style-type: none"> Establishment of our Group, primarily engaged in the business trading principally as a wholesaler in the supply of coffee and tea products
1956	<ul style="list-style-type: none"> Incorporation of TWHK
1963	<ul style="list-style-type: none"> Acquisition of our own factory in Beech Street, Kowloon for coffee roasting and packaging
1978	<ul style="list-style-type: none"> Mr. Wong joined our Group
1980	<ul style="list-style-type: none"> Acquisition of properties in Kwai Tak Industrial Centre in Kwai Chung, New Territories, Hong Kong for our production and as our Group's head office
1982	<ul style="list-style-type: none"> Adoption of computerized coffee processing line and machineries from the United States
1994	<ul style="list-style-type: none"> Establishment of ZHTW
2000	<ul style="list-style-type: none"> Incorporation of our Company
2001	<ul style="list-style-type: none"> Our Company was listed on the main board of SGX-ST
2004	<ul style="list-style-type: none"> COFE was awarded "Hong Kong Top Brand Awards — 2004 Emerging Brand" by the Chinese Manufacturers' Association of Hong Kong

HISTORY, DEVELOPMENT AND CORPORATE STRUCTURE

Year	Event
2005	<ul style="list-style-type: none"> ● Our Group was awarded “Superbrands” by the Hong Kong Superbrands Council
2006	<ul style="list-style-type: none"> ● COFE was recognised under the “Hong Kong Q-Mark Product Scheme” by Hong Kong Q-Mark Council, Federation of Hong Kong Industries ● The management system of COFE was awarded ISO 9001:2008 accreditation for quality management system by SGS United Kingdom Limited ● The management system of COFE was awarded HACCP Codex Alimentarius Certificate by SGS Hong Kong Limited ● Our Group adopted ERP system in Hong Kong to enhance production efficiency
2008	<ul style="list-style-type: none"> ● The management system of COFE was awarded ISO 22000:2005 accreditation, a food safety management system recognition, for our roasted coffee and tea production line ● ZHTW was designated as the beverage product supplier at 2008 Beijing Olympics
2009	<ul style="list-style-type: none"> ● Establishment of DGTW for setting up an integrated production and service centre of our Group in Dongguan, the PRC
2010	<ul style="list-style-type: none"> ● The management system of COFE was awarded ISO 14001:2004 accreditation for quality management system by SGS United Kingdom Limited ● The Guangzhou branch office of SHTW together with ZHTW were designated as the food supplier for the 16th Asian Games in Guangzhou, the PRC
2011	<ul style="list-style-type: none"> ● The Guangzhou branch office of SHTW was designated as the beverage product supplier for the Shenzhen Summer Universiade Games
2013	<ul style="list-style-type: none"> ● Our Company underwent privatization and was delisted from SGX-ST ● Incorporation of Whole Sun for the purpose of acquiring the business and assets of Oriole Properties Limited, which marked the commencement of our frozen food business

HISTORY, DEVELOPMENT AND CORPORATE STRUCTURE

Year	Event
2015	<ul style="list-style-type: none">● We further expanded our business in food market by importing frozen processed food
2016	<ul style="list-style-type: none">● Launch of the TWG Coffee Connoisseurs Academy
2017	<ul style="list-style-type: none">● Our Company entered into a strategic cooperation agreement with NH Foods
2018	<ul style="list-style-type: none">● Our Company entered into a memorandum of understanding with F&N

Delisting from SGX-ST

Our Company was incorporated under the laws of Bermuda on June 13, 2000 as an exempted company with limited liability, and was listed on the SGX-ST on December 14, 2001. Our Directors at the relevant time considered that SGX-ST was a more preferred destination for the listing of our Company primarily due to our Directors' view that the investment environment in Hong Kong during the early 2000s was more favourable for the information technology industry, which was generally perceived to have higher growth capacity than production of consumer goods such as food and beverages. We remained listed on the SGX-ST until October 3, 2013, during which time we did not breach any requirement of the listing rules of the SGX-ST and were not subject to any disciplinary action, whether private or public, by the SGX-ST or other regulatory authorities in Singapore.

On June 25, 2013, DBS Bank Limited, on behalf of Hero Valour as the offeror, announced the mandatory unconditional cash offer for all the offer shares of our Company (the "**Delisting Offer**").

The terms of the Delisting Offer were as follows:

- (i) Hero Valour offered to pay S\$0.3075 in cash for each offer share of our Company and this price was applicable to any number of shares tendered in acceptance of the Delisting Offer;
- (ii) the Delisting Offer was unconditional in all respects; and
- (iii) the shares of our Company acquired by Hero Valour were fully paid and free from all encumbrances and other third party rights.

HISTORY, DEVELOPMENT AND CORPORATE STRUCTURE

The reasons for the delisting of our Company, amongst others, were as follows:

(a) Opportunity for the Shareholders to Realize their Investments at a Premium

The Delisting Offer provided an opportunity for our then minority Shareholders to realize the value of their investments in our Company at a premium over the historical trading prices of our Shares on the SGX-ST, an option which might not otherwise be readily available.

(b) Low Trading Liquidity and Low Free Float of Shares

Based on the historical trading records, the liquidity of our Shares on the SGX-ST had been generally low partially attributable to the low free float of our Shares. The Delisting Offer provided an exit opportunity for those Shareholders who wished to realize their entire investment in our Shares but had found it difficult to do so as a result of the low trading liquidity of our Shares.

(c) Greater Management Flexibility

The delisting would facilitate greater management flexibility to manage and plan our Group's business on a longer time horizon to optimize the use of our management and capital resources. In particular, as we had no office or establishment in Singapore, our Directors had to travel regularly to Singapore for a few times each year for attending annual general meetings and other meetings with the then independent non-executive Directors and legal advisers of our Company in Singapore. Our Directors consider that the delisting would achieve greater management flexibility by enabling our management to better utilize the time and cost that would have otherwise incurred, so as to better focus on our Group's business development.

(d) Eliminate Compliance Costs

Our Company would also dispense with the expenses relating to the maintenance of a listed status and focus its resources on our business operations. Our then Directors had considered that it was not cost effective and efficient to deploy our resources in Singapore as our main operation is conducted in Hong Kong. The delisting would allow our Company to rationalize the management, resources and cost structure of our Group's businesses and enable us to channel such resources towards our business operation instead.

Pursuant to the Delisting Offer, Hero Valour, through its financing from a private company, purchased our Shares from Shareholders who accepted the Delisting Offer at S\$0.3075 per share and exercised its right to compulsorily acquire all our Shares of the remaining Shareholders who had not accepted the Delisting Offer under section 103 of the Companies Act. The compulsory acquisition was completed on October 1, 2013 and our Company was subsequently delisted from the SGX-ST on October 3, 2013.

HISTORY, DEVELOPMENT AND CORPORATE STRUCTURE

Market Capitalization

The market capitalization of our Company at the time of its delisting from the SGX-ST on October 3, 2013 was S\$65.6 million (based on the exchange rate of HK\$6.21 to S\$1 on October 3, 2013, equivalent to approximately HK\$407.4 million). Our market capitalization upon Listing is expected to be between HK\$1,086.0 million (based on the low end of the Offer Price range) and HK\$1,585.5 million (based on the high end of the Offer Price range). We believe our higher expected market capitalization upon Listing is primarily due to:

- (i) expected stronger investor demand in Hong Kong as a result of (a) greater liquidity and a larger and more diversified investor base with respect to the Hong Kong Stock Exchange and (b) the proximity between Hong Kong and mainland China, which is a focus for our future growth;
- (ii) the commencement of our frozen food business since 2013, which has contributed to the growth of our revenue and profit during the Track Record Period; and
- (iii) the expected proceeds from the Global Offering which are accounted for in our projected market capitalization upon the Listing.

Material Development after Delisting

After delisting from the SGX-ST, material development of our Group up to the Latest Practicable Date is set out as follows:

(a) Deregistration of ZHTW

ZHTW was deregistered on December 30, 2013 as a result of the relocation of our production and service to our integrated production and service centre located in Dongguan, the PRC. The deregistration of ZHTW was properly and legally completed and settled and all relevant approvals have been obtained.

(b) Incorporation, Acquisitions and Disposal of Elect Gold

On December 18, 2013, Elect Gold was incorporated in the BVI. Elect Gold is authorized to issue a maximum of 50,000 shares of par value US\$1.00 each of a single class. One ordinary share of Elect Gold was allotted and issued to our Company on March 13, 2014. Elect Gold was incorporated as an investment holding company for the purpose of acquiring certain companies engaging in the ice-cream business. The first director of Elect Gold was Mr. Wong, appointed on March 13, 2014.

Pursuant to a sale and purchase agreement (the “**HKDD Agreement**”) dated May 20, 2014 entered into amongst Elect Gold (as purchaser), Super Active Profits Limited (as vendor) and Wong Sek Yuen Peter (as warrantor), both being Independent Third Parties, Elect Gold acquired 8,000 issued ordinary shares of HKDD representing 80% of its issued share capital at a cash consideration of HK\$5.2 million on June 3, 2014 to explore and develop ice-cream business. Such consideration was determined with

HISTORY, DEVELOPMENT AND CORPORATE STRUCTURE

reference to primarily the benefit of expected synergies and revenue growth of the companies to be acquired. Upon completion of the above share transfer, HKDD became 80% and 20% owned by Elect Gold and Super Active Profits Limited, respectively. At the time of the HKDD Agreement, HKDD had a wholly-owned subsidiary, namely GZDD, a company established in the PRC on April 9, 1994 and engaged in the sales of ice-cream in the PRC.

On September 1, 2014, as part of the group restructuring under the HKDD Agreement, HKDD became sole shareholder of Bofon, a company holding the ice-cream trademark. On June 30, 2015, DD(GZ) CC was incorporated as a wholly-owned subsidiary of HKDD for the purpose of conducting retail sales of ice-cream products in the PRC.

Elect Gold recorded a loss of approximately HK\$7.1 million and HK\$1.2 million (before taking into account gain on disposal of the entire issued share of Elect Gold) for the years ended December 31, 2015 and 2016, respectively. We recognized impairment losses of approximately HK\$4.9 million in respect of goodwill for the year ended December 31, 2015, reflecting the lower than expected profitability of this business as a result of keen competition in ice-cream products in the PRC market. Our Directors consider that maintaining the operation of ice-cream business would require substantial resources which may not be in the best interest of our Group. With a view to allowing our Group to focus on other business lines with better prospects, pursuant to a memorandum for sale and purchase dated May 30, 2016 entered into between our Company and Hero Ace, our Company transferred one ordinary share, being the only issued share, of Elect Gold to Hero Ace, an investment holding company incorporated in the BVI and wholly-owned by Mr. Wong, at a nominal consideration of US\$1.00 on May 31, 2016. Our Directors consider that the disposal at nominal consideration was fair and reasonable given the significant goodwill impairment loss incurred after the acquisition. The acquisition and disposal of Elect Gold were properly and legally completed and settled.

(c) Establishment of DG TWG Heritage

On January 7, 2014, DG TWG Heritage was established in the PRC with an initial registered capital of RMB13.5 million, out of which approximately RMB10.1 million has been paid up by HK TWG Heritage as of the Latest Practicable Date. DG TWG Heritage was set up to engage in the business of wholesale, import and export of powdered drinks, roasted coffee, coffee making equipment, tea making equipment and sub-packaging of tea leaves.

(d) Incorporation of Whole Sun for the purpose of acquiring the business and assets of Oriole Properties Limited

On January 7, 2013, Whole Sun was incorporated under the laws of Hong Kong. For details relating to the corporate development of Whole Sun, please refer to the paragraph headed “Our Corporate Development — Whole Sun” in this section.

HISTORY, DEVELOPMENT AND CORPORATE STRUCTURE

On January 24, 2013, Oriole Properties Limited as the seller and Whole Sun as the buyer entered into an agreement with TWIC, Mr. Chu Sun Chi (“**Mr. Chu**”) and Ms. Fan Yin Fun, the spouse of Mr. Chu (“**Mrs. Chu**”) for the sale and purchase of the business of marketing and selling of frozen food carried on by Oriole Properties Limited and the related business assets as defined in the agreement together with the goodwill of such business at a total cash consideration of HK\$33.6 million. Such consideration was determined with reference to valuation based on discounted cash flow projection. As at the time of the agreement, Oriole Properties Limited was held by Mr. Chu and Mrs. Chu in equal proportion. The completion of this transaction took place on March 5, 2013. The acquisition of business was properly and legally completed and settled.

(e) Acquisition of HK TWG Heritage

On January 10, 2017, pursuant to a memorandum for sale and purchase dated December 30, 2016 entered into between Heritage Teas (Private) Limited and TWCI, TWCI acquired 300,000 shares, representing 20% of the issued share capital, of HK TWG Heritage, from Heritage Teas (Private) Limited, an Independent Third Party, at a cash consideration of US\$124,753 based on the net asset values of HK TWG Heritage and DG TWG Heritage as at 31 December 2016. On the same day, pursuant to a memorandum for sale and purchase dated December 30, 2016 entered into between Global Tea Trading and TWCI, TWCI acquired 435,000 shares, representing 29% of the issued share capital of HK TWG Heritage, from Global Tea Trading (a wholly-owned subsidiary of our Company), at a nominal consideration of HK\$1.00. After the above acquisitions, HK TWG Heritage became a direct wholly-owned subsidiary of TWCI. The acquisitions of HK TWG Heritage were properly and legally completed and settled.

(f) Share Subscription Agreement

Pursuant to a share purchase and subscription agreement entered into amongst Hero Valour, the Former Shareholder, our Company and Mr. Wong (the “**Share Subscription Agreement**”) dated October 10, 2014, our Company allotted and issued 31,789,282 ordinary Shares of par value HK\$0.25 each to the Former Shareholder for a cash consideration of approximately HK\$119.25 million on October 17, 2014. Meanwhile, Hero Valour transferred 10,596,427 ordinary Shares to the Former Shareholder for a cash consideration of approximately HK\$39.75 million. Such consideration was determined with reference to valuation based on discounted cash flow projection. At the time of such allotment and transfer, the Former Shareholder was a supplier of our Group. Upon completion, the Former Shareholder held an aggregate of 42,385,709 Shares, representing approximately 17.16% of the then issued share capital of our Company on a fully diluted basis. Prior to the investment, the Former Shareholder had developed a mutual beneficial business relationship with our Group for over ten years under which we could utilize the sourcing network of the Former Shareholder to access to quality materials while the Former Shareholder managed to enhance the brand awareness of its products through our well-established and diversified customer base. During the Former Shareholder’s investment in the

HISTORY, DEVELOPMENT AND CORPORATE STRUCTURE

Company, we have shared our sales and marketing channels to help the Former Shareholder to launch new products in the Hong Kong and PRC markets. After taking into account the less-than-expected synergy effects arising therefrom and the difference in management style and corporate culture, on March 2, 2016, the Former Shareholder decided to divest the investment and sold and transferred all the 42,385,709 Shares to Hero Valour at a consideration of HK\$136.62 million pursuant to the put option right of the Former Shareholder as stipulated in the Share Subscription Agreement. Such consideration was determined with reference to valuation based on discounted cash flow projection. After the divestment, the Former Shareholder remained as a supplier of the Group.

(g) Entering into Strategic Cooperation Agreement with NH Foods

On July 27, 2017, our Company entered into a strategic cooperation agreement with NH Foods to develop business opportunities in Hong Kong, Macau and the PRC with regard to frozen, fresh, pre-cooked processed meat and seafood products. Under the terms of the strategic cooperation agreement:

- our Company and NH Foods in principle agreed to cooperate with each other to explore future food business opportunities in the PRC, Hong Kong and Macau particularly regarding meat related business. Our Company and NH Foods agreed to jointly optimize product development, maintain sufficient stock and product and to provide periodic training to staff;
- our Company further agreed to negotiate with NH Foods in good faith to decide the most suitable form of cooperation to conduct a concrete business in the future and would enter into formal agreements after the main terms and conditions of the concrete business are decided; and
- if our Company wishes to create a relationship of partnership, joint venture or agency, a written offer to form such relationship shall be made to NH Foods first. Only if both parties fail to reach an agreement within 60 days after such offer is made to NH Foods, our Company may proceed to form such relationship with a third party.

HISTORY, DEVELOPMENT AND CORPORATE STRUCTURE

(h) Entering into Memorandum of Understanding with F&N

On April 19, 2018, our Company entered into a memorandum of understanding with F&N with the aim to explore business and product development opportunities in Hong Kong, Macau, the PRC and/or the Southeast Asia through co-operation on strategic alliance initiatives including the following:

- F&N to be appointed as our Company's exclusive supplier of evaporated and condensed milk products;
- distribution of alcoholic and non-alcoholic beverage products of F&N and its affiliates by our Company;
- distribution of our Company's coffee and tea products by F&N;
- co-branded promotion of our Company's products and the products of F&N in food outlets; and
- co-development of new Ready-To-Drink products and beverage solutions.

Our Company and F&N will enter into formal agreements and relevant ancillary documents after deciding the terms and conditions of such cooperation.

Application for Listing on the Hong Kong Stock Exchange

Our Directors consider Hong Kong to be a suitable place for Listing as they believe that with the business and operations of our Group primarily located, managed and conducted in Hong Kong, a listing in Hong Kong will not only contribute to opportunities for future fund-raising and potential improvement in the trading liquidity and valuation of our Shares, but also provide better synergy for our Group in terms of branding and raising our corporate profile. Our Directors also believe that the Listing will enable our Group to attract and retain talented people and strengthen the corporate governance and internal control of our Group and thus increase the value of our Group as a whole. Our Directors further believe that the close proximity between Hong Kong and mainland China will also allow our Group to better utilize and deploy our management and resources with greater efficiency, flexibility and competitiveness.

HISTORY, DEVELOPMENT AND CORPORATE STRUCTURE

OUR CORPORATE DEVELOPMENT

The major corporate development including the major shareholding change of the material subsidiaries of our Group which were material to the performance of our Group during the Track Record Period is set out below:

Our Company

On June 13, 2000, our Company was incorporated under the laws of Bermuda with an initial authorized share capital of HK\$100,000 comprising 1,000,000 Shares of par value HK\$0.10 each, all of which were subsequently allotted and issued to Wong's Brothers Consortium Inc., a company incorporated under the laws of the BVI. The shareholders of Wong's Brothers Consortium Inc. were three companies incorporated under the laws of the BVI, namely Swift Mind Holdings Limited, Prosperous Town Limited and Global King International Limited, in the shareholding proportions of 22.2%, 47.3% and 30.5%, respectively. All of them were corporate trustees with members of Mr. Wong's family as beneficiaries. On June 23, 2010, all the issued shares of Wong's Brothers Consortium Inc. held by Swift Mind Holdings Limited were redeemed and cancelled.

By resolutions passed at a special general meeting of our Company held on November 29, 2001, our Company consolidated every five ordinary Shares of par value HK\$0.10 each in the authorized and issued share capital of our Company into two ordinary Shares of par value HK\$0.25 each and accordingly the authorized share capital of our Company became HK\$100,000 divided into 400,000 ordinary Shares of par value HK\$0.25 each, and increased our authorized share capital to HK\$100,000,000 by the creation of 399,600,000 additional ordinary Shares of par value HK\$0.25 each. As a result, our Company had an authorized share capital of HK\$100,000,000 comprising 400,000,000 ordinary Shares of par value HK\$0.25 each.

After a series of allotments and transfers of shares, save for a period between October 17, 2014 to March 2, 2016 during which the Former Shareholder was one of our Shareholders, our Company has been wholly-owned by Mr. Wong through Hero Valour since the delisting of our Company from SGX-ST. For further details of the Former Shareholder, please refer to the paragraphs headed "Material Development after Delisting — (f) Share Subscription Agreement" in this section.

On September 4, 2017, written resolutions of the sole Shareholder has been passed pursuant to which, among other things:

- (i) 86,719 ordinary Shares of par value HK\$0.25 each, credited as fully paid, were allotted and issued to Hero Valour for a cash consideration of HK\$21,679.75;
- (ii) every two issued and unissued ordinary Shares of par value HK\$0.25 each were subdivided into five ordinary Shares of par value HK\$0.10 each, such that immediately following the Share Subdivision, the authorized share capital of our Company became HK\$100,000,000 divided into 1,000,000,000 Shares of par value HK\$0.10 each; and

HISTORY, DEVELOPMENT AND CORPORATE STRUCTURE

(iii) the authorized share capital of our Company was increased from HK\$100,000,000 divided into 1,000,000,000 Shares of par value HK\$0.10 each to HK\$200,000,000 divided into 2,000,000,000 Shares of par value HK\$0.10 each, by the creation of 1,000,000,000 new Shares.

Our Company is an investment holding company.

(a) Major subsidiaries of TWIC

TWHK

On January 3, 1956, TWHK was incorporated in Hong Kong with an authorized share capital of HK\$500,000 divided into 1,000 ordinary shares of HK\$500.00 each.

By a special resolution passed by the then shareholders of TWHK on March 17, 1970, its authorized share capital was increased to HK\$1,000,000 by creation of 1,000 additional ordinary shares of HK\$500.00 each. By a special resolution passed by the then shareholders of TWHK on August 9, 1972, every issued and unissued ordinary share of HK\$500.00 each was subdivided into 100 fully paid shares of HK\$5.00 each. On August 12, 1972, by a special resolution passed by the then shareholders of TWHK, HK\$250,000 standing to the credit of profit and loss account was capitalized and 50,000 shares were allotted and issued to the then shareholders of TWHK with each of them being entitled to one share for every three shares held. By a special resolution passed by the then shareholders of TWHK on February 3, 1977, the authorized share capital of TWHK was increased to HK\$2,000,000 by creation of 200,000 additional ordinary shares of HK\$5.00 each. By a special resolution passed by the then shareholders of TWHK on April 11, 1978, the authorized share capital of TWHK was further increased to HK\$5,000,000 by creation of 600,000 additional shares of HK\$5.00 each. By a special resolution passed by the then shareholders of TWHK on April 29, 1992, the authorized share capital of TWHK was increased to HK\$6,000,000 divided into two classes of share: (i) 172,400 ordinary shares of HK\$5.00 each; and (ii) 1,027,600 5% non-voting deferred shares of HK\$5.00 each.

On the date of its incorporation, the initial subscribers of TWHK were our Founder and Wong Sek Fook, each of whom was allotted and issued with one share of HK\$500.00 each. After a series of allotments and transfers of shares, Mr. Wong held one ordinary share of TWHK of HK\$5.00 each, and TWIC held 999 ordinary shares of HK\$5.00 each and 1,027,600 5% non-voting deferred shares of TWHK of HK\$5.00 each. TWHK has been wholly-owned by TWIC since September 26, 2014 when Mr. Wong transferred his one ordinary share of TWHK to TWIC.

TWHK is an investment holding company for four wholly-owned subsidiaries of our Company, namely COFE, CDEL, TWHKFF and TW Beverage Machine. TWHK also holds all the production premises, warehouses and car parking spaces owned by our Group in Hong Kong.

HISTORY, DEVELOPMENT AND CORPORATE STRUCTURE

COFE

On December 10, 1992, COFE was incorporated in Hong Kong with an authorized share capital of HK\$10,000 divided into 10,000 shares of HK\$1.00 each.

On the date of its incorporation, the initial subscribers of COFE were Becmac Limited and Camceb Limited, each of whom was allotted and issued with one share of HK\$1.00 each. On December 30, 1992, TWHK subscribed for and was issued with 9,998 shares of COFE. On February 10, 1993, Camceb Limited transferred its only one share of COFE to TWHK, and Becmac Limited transferred its only one share of COFE to Mr. Wong on December 8, 2000, which was then transferred to TWHK on September 26, 2014. Since September 26, 2014, COFE has become wholly-owned by TWHK.

The principal activities of COFE are processing of coffee beans, distribution of coffee, tea and related complementary products, sale and rental of coffee and tea machines and sale of frozen processed food.

CDEL

On November 28, 1978, CDEL was incorporated in Hong Kong with an authorized share capital of HK\$2,000,000 divided into 400,000 shares of HK\$5.00 each.

On the date of its incorporation, the initial subscribers of CDEL were our Founder and Mr. Wong, each of whom was allotted and issued with one share of HK\$5.00 each. On December 14, 1978, 101,999 and 29,999 shares of CDEL were allotted to TWHK and Mr. Wong, respectively, amongst nine allottees of this share allotment. Upon completion of such allotment, TWHK and Mr. Wong held approximately 51.0% and 15.0%, respectively of the then issued share capital of CDEL. After a series of allotments and transfers of shares, CDEL has become wholly-owned by TWHK since September 26, 2014.

The principal activity business of CDEL is distribution of grocery products.

TW Beverage Machine

On October 5, 1993, TW Beverage Machine was incorporated in Hong Kong with an authorized share capital of HK\$10,000 divided into 10,000 shares of HK\$1.00 each.

On the date of its incorporation, the initial subscribers of TW Beverage Machine were Becmac Limited and Camceb Limited, each of whom was issued and allotted with one share of HK\$1.00 each. On November 11, 1993, TWHK acquired one share, representing 50% of the then issued share capital of TW Beverage Machine, from Camceb Limited. On December 8, 2000, Mr. Wong acquired one share of TW Beverage Machine from Becmac Limited. After Mr. Wong transferred his one share of TW Beverage Machine to TWHK on September 26, 2014, TW Beverage Machine has become wholly-owned by TWHK.

HISTORY, DEVELOPMENT AND CORPORATE STRUCTURE

The principal activities of TW Beverage Machine are trading of coffee machines and related products.

Whole Sun

On January 7, 2013, Whole Sun was incorporated in Hong Kong with an authorized share capital of HK\$10,000 divided into 10,000 ordinary shares of HK\$1.00 each.

On the date of its incorporation, the initial subscribers of Whole Sun were TWFF, Mr. Chu and Mrs. Chu who held 6,000, 2,000 and 2,000 ordinary shares of Whole Sun, representing 60%, 20% and 20% of the issued share capital of Whole Sun, respectively. On October 12, 2016, TWIC acquired 6,000 shares of Whole Sun, representing 60% of the issued share capital of Whole Sun, from TWFF at a consideration of HK\$6,000. As of the Latest Practicable Date, Whole Sun was held as to 60%, 20% and 20% by TWIC, Mr. Chu and Mrs. Chu, respectively. For further details, please refer to the paragraph headed “History, Development and Corporate Structure — Material Development after Delisting — (d) Incorporation of Whole Sun for the purpose of acquiring the business and assets of Oriole Properties Limited” in this section.

During the Track Record Period, apart from his interest in Whole Sun, Mr. Chu was also a shareholder and director of Oriole, which was held as to 52.4% and 47.6% by Mr. Chu and Mr. Chu Cho Wing, the son of Mr. Chu, respectively, until Mr. Chu transferred all his shareholding in Oriole to Mr. Chu Cho Wing on September 4, 2017 with a view to avoiding any possible potential competition between Whole Sun and Oriole. Mr. Chu also resigned as a director of Oriole on September 4, 2017. Mr. Chu has also confirmed that Mr. Chu Cho Wing is not acting as his trustee or nominee and that he has no role in any aspects of the business management of Oriole.

On July 12, 2017, Mr. Chu and Mrs. Chu (the “**Covenantors**”) entered into a deed of non-competition (the “**Non-Compete Undertaking**”) in favour of our Company and have undertaken and covenanted with our Company (for itself and on behalf of Whole Sun and other subsidiaries of our Group engaging in the business of trading and processing of frozen, chilled and pre-cooked food and any other food-related business (the “**Restricted Business**”)) not to at any time during the period that the Non-Compete Undertaking remains effective, directly or indirectly, (a) engage in any business which is the same as, similar to or in competition with the Restricted Business; (b) entice away from Whole Sun and other subsidiaries of our Group engaging in the Restricted Business any persons or firms which in the past one year had been their customer, supplier, business partner or employee for the purpose of engaging in the Restricted Business; (c) do or say anything which may be harmful to the reputation of Whole Sun and/or other subsidiaries of our Group engaging in the Restricted Business; and (d) make use of any information pertaining to the business of Whole Sun and/or other subsidiaries of our Group engaging in the Restricted Business for the purpose of competing with the business of our Group.

HISTORY, DEVELOPMENT AND CORPORATE STRUCTURE

The Non-Compete Undertaking and the rights and obligations thereunder are conditional and will take effect immediately upon Listing. The obligations of the Covenantors under the Non-Compete Undertaking shall cease if (a) our Shares cease to be listed on the Main Board of the Hong Kong Stock Exchange; or (b) in respect of a Covenantor, the date on which the Covenantor and/or his/her associates ceases to be the controlling shareholder(s) of Whole Sun.

The principal activity of Whole Sun is trading of frozen meat.

(b) Major subsidiaries of TWCH***TWCI***

On December 15, 1999, TWCI was incorporated in Hong Kong with an authorized share capital of HK\$23,400,000 divided into 3,000,000 shares of HK\$7.80 each. On the date of its incorporation, the initial subscribers were Becmac Limited and Camceb Limited, each of whom was issued and allotted with one share of HK\$7.80 each. Subsequent to a series of allotments and transfers of shares between 2000 and 2006, TWIC held 2,854,459 shares on April 27, 2006, representing the entire issued share capital of TWCI. On November 29, 2012, TWIC transferred 2,854,458 shares of TWCI to TWCH at a consideration of HK\$22,264,780.20. Since October 6, 2014, on which TWIC transferred the remaining one share of TWCI to TWCH at a consideration of HK\$1.00, TWCH has become the sole shareholder of TWCI. TWCI is an investment holding company of two of our major operating subsidiaries, namely DGTW and DG TWG Heritage.

DGTW

On September 11, 2009, DGTW was established under the laws of the PRC with the initial registered capital of HK\$78.88 million, which has been fully paid up by TWCI.

The principal activities of DGTW are processing of coffee beans, distribution of coffee, tea and related complementary products and sale of food and beverages.

DG TWG Heritage

On January 7, 2014, DG TWG Heritage was established under the laws of the PRC with an initial registered capital of RMB13.5 million, out of which approximately RMB10.1 million has been paid up by HK TWG Heritage as of the Latest Practicable Date.

DG TWG Heritage was established for the business of the wholesale, import and export of powdered drinks, roasted coffee, coffee marking equipment, tea making equipment and the sub-packaging of tea leaves.

The principal activity of DG TWG Heritage is processing of tea products.

HISTORY, DEVELOPMENT AND CORPORATE STRUCTURE

SHTW

On June 6, 2003, SHTW was established under the laws of the PRC with an initial registered capital of US\$300,000 which has been fully paid up by TWCE. After several amendments had been made to the articles of SHTW, the registered capital of SHTW was increased to US\$2,400,000 on August 20, 2006. Subsequent to a series of capital injection which took place between November 2003 and December 2006, all the registered capital of SHTW had been fully paid up.

On October 18, 2007, the Shanghai Foreign Investment Commission approved the application to set up branch offices in Beijing and Guangzhou submitted by SHTW. The Beijing branch office and Guangzhou branch office of SHTW were established on December 12, 2007 and January 28, 2008, respectively.

The principal activities of SHTW and its branch offices are trading of coffee, tea and related complementary products, sale and rental of coffee and tea machines and sale of frozen processed food in the PRC.

CDCL

On October 19, 2011, CDCL was established under the laws of the PRC with an initial registered capital of HK\$5.0 million, which has been fully paid up by TWCE. At the time of its establishment, CDCL was established as a wholly-owned foreign enterprise. Since its establishment, TWCE remains the sole shareholder of CDCL.

The principal activities of CDCL are trading of coffee machines and related products in the PRC.

CDTL

On July 26, 2012, CDTL was established under the laws of the PRC with a registered capital of RMB5.0 million which has been fully paid up by TWCT.

The principal activity of CDTL is trading of goods in the PRC.

HISTORY, DEVELOPMENT AND CORPORATE STRUCTURE

Note 2: TWFF, Global Tea Trading and TWCC are under the process of deregistration as of the Latest Practicable Date.







Note 3: TWHKFF had no business operations as of the Latest Practicable Date.

Note 4: NH Foods has agreed to subscribe for our Shares at the Offer Price with an investment amount of one billion Japanese Yen. The number of Shares to be subscribed by NH Foods represents 5.47% of our total issued Shares (based on the mid-point of the Offer Price range of HK\$1.84 and the indicative exchange rate of one Japanese Yen to HK\$0.0729 as of the Latest Practicable Date).

BUSINESS

OVERVIEW

We are a leading integrated B2B coffee and black tea solutions provider in Hong Kong, Macau and the PRC with an established food products business. Our 85-year heritage originates from an outlet providing coffee roasting and trading of coffee and tea in 1932. Since then, we have grown into a well-trusted brand in Hong Kong, Macau and the PRC providing one-stop coffee and tea solutions services to commercial customers that cover the entire coffee and tea procurement, processing and distribution value chain. In the PRC, we have established a stable beverage solutions business, which we believe has good growth potential as reflected in our financial results for the year ended December 31, 2017. With a view to better serve our customers, we broadened our business scope and commenced our food products business in Hong Kong and the PRC in 2013 and frozen processed food business in Hong Kong in 2015 and in the PRC in 2016.

We have developed a stable and diverse group of customers that include fast food chains, Cha Chaan Tengs, luxury hotels, cafe and restaurants, and leading fast food industry participants, such as franchised business of McDonald's in the PRC and Hong Kong , Yoshinoya, 7-Eleven , Café de Coral , Fairwood , Tsui Wah, Tai Hing  and Spaghetti House . Together with our customers, we catered to generations of end consumers in the regions we serve and successfully evolved to meet changing consumer tastes. We provide a total solution for coffee and black tea, with an expertise on Hong Kong-style milk tea. At the same time, we implemented various measures that we believe contributed to the advancement of the coffee and black tea culture in Hong Kong, including providing coffee machines along with our coffee products since 2003 to fast food chains and Cha Chaan Teng in Hong Kong to serve fresh brewed coffee and espresso. We believe such measures not only elevated the consumer experience, but also enhanced our brand recognition amongst our customers and/or their end-users, which in turn, strengthened our business growth and leading market position. According to Frost & Sullivan, we were the largest B2B coffee and black tea solutions provider in Hong Kong in 2016, and the third and fourth largest B2B coffee and black tea solutions provider in Macau and the PRC, respectively, in 2016 in terms of B2B revenue. In addition, in 2016, we were the largest Sri Lanka tea importer in terms of volume in Hong Kong and the third-largest Sri Lanka tea importer in terms of volume in the PRC.

We take pride in being a trusted coffee and tea solutions provider to our customers. We believe our success is based on our proactive approach towards understanding our customers' needs, adapting our operation to meet their demand and applying our wealth of industry knowledge to forming economical solutions quickly. In particular, to help our customers attain their goals, we leverage off our well-established network of renowned suppliers to access to a comprehensive portfolio of quality-assured materials. While at the product execution stage, we reach to our rich roasting, blending and mixing experience and rely on our automated production system to deliver safe and reliable tailor-made products in mass volumes. We have the ability to simultaneously produce different products that are packaged for wholesale and/or assembling them in retail ready portions to fulfill the demands of our diverse customer base. Moreover, to make sure our proposed coffee and tea solutions can be implemented consistently with the desired effect, we not only help our customers form the product but also provide the essential coffee equipment and design the

BUSINESS

details of the preparation techniques. Building on our strong customizing capability, we often closely collaborate with our customers in designing specialty formulations. During the Track Record Period, we collaborated with renowned fast food chains and other well-known food and beverage service providers in introducing customized beverages of various flavors to be served in different seasons. Such close collaboration allows us to gain valuable market knowledge, and we believe the proven success of such products has also further strengthened our customer loyalty.

Our ability to customize beverage solutions and our “customer first”, “solution driven” principles have helped us build a stable and diverse customer base. We provide services and deliver products to both food and beverage providers that satisfy the demand of the mass market and that of a niche segment that demand for specialized products. We believe we are one of the few coffee and tea solutions providers in Hong Kong that have the ability to consistently meet the scaled demands of fast food chains and Cha Chaan Teng, and at the same time, bring quality solutions to customers that serve a niche consumer market. Our diverse customer base gives us a multi-channel distribution network that can reach approximately 60% of the food outlets in Hong Kong in 2016, which include approximately up to 77.6%, 70.3% and 78.7% market coverage of fast food stores, Cha Chaan Tengs and cafes respectively. The extensive market exposure coupled with our dedication to customer needs keep us abreast of the latest consumer preferences across market segments and continue to introduce innovative coffee and tea solutions. In turn, we apply such knowledge to form new beverage flavors for our customers, and thus creating a positive cycle of knowledge accumulation.

In 2017, coffee sold by us can be made into 253.2 million to 337.7 million cups of coffee per year and between 693,800 to 925,100 cups of coffee per day (assuming nine to 12 grams of coffee is applied to produce each cup), while tea sold by us can be made into 302.4 million to 403.2 million cups of milk tea per year and between 828,500 to 1,104,600 cups of milk tea per day (assuming nine to 12 grams of tea is applied to produce each cup of milk tea). As our products are consumed by a sizeable population on a daily basis, we have an unwavering commitment to food safety and consistent service quality. Our stringent quality control process starts with sourcing from suppliers with internationally-accredited quality certifications, and journeys through our operations in Hong Kong and the PRC under the strict commitment to internationally recognized standards, including HACCP, ISO 9001:2008, ISO 14001:2004 and ISO 22000:2005. We have also installed automated and digitized systems that monitor and instantly record production data to ensure full traceability by pack. Our commitment to food safety has been recognized by leading food and beverage service providers, including franchised business of McDonald’s in the PRC and Hong Kong, known to enforce stringent quality standards. Moreover, we have been recognized as Hong Kong top brand mark since 2009 and were appointed the beverage product supplier at 2008 Beijing Olympics and 2011 Shenzhen Summer Universiade Games. We were also appointed as the food supplier for the 16th Asian Games in Guangzhou in 2010. We believe these official appointments, certifications and initiatives signify our commitment to food safety and consistent service quality, and have been the foundation to our strong track record.

BUSINESS

We broadened our business scope to provide food supplies to our B2B customers and commenced our frozen meat business in Hong Kong and the PRC in 2013, and our frozen processed food business in Hong Kong in 2015 and in the PRC in 2016. We import frozen meat products, mainly beef, pork, poultry and lamb from international meat suppliers located in countries including Brazil, New Zealand, Japan, United States, Thailand and the PRC. We follow market developments closely to provide cost-competitive frozen meat products for our major customers, who are primarily wholesalers catering to fast food chains and Cha Chaan Tengs. We have on average over four years of experience serving our major frozen meat product customers. We believe such stable business relationship is built on a commitment and ability to continuously procure and provide quality food products, according to our customers' demand at competitive prices.

Moreover, in 2016, we introduced our processed food products under our "Papa Chef" brand as part of a horizontal business expansion to capture the growth opportunities in the frozen processed food markets and other cross-selling opportunities. Going forward, we aim to provide frozen meat and frozen processed food to our customers and integrate such products into our customers' central kitchen. In addition, we entered into a strategic cooperation agreement in July 2017 with NH Foods, to jointly develop the food products market in Hong Kong, Macau and the PRC. We believe that our market knowledge and well-established customer base combined with NH Foods's expertise in food products, experience and resource strengthens our product portfolio and positions us well to develop targeted markets in Hong Kong, Macau and the PRC, including meeting the demand of tailor made products to our B2B customers in the fast food market. Furthermore, we entered into a memorandum of understanding with F&N in April 2018 to explore business and product development opportunities for the supply, distribution, co-branded promotion and co-development of beverage products and/or beverage solutions.

We have adopted an integrated business intelligence system that connects different segments of our operation. Through such system, we can efficiently coordinate our production planning, supply chain management and business development plans. Timely access to the daily inventory and sales data allows our management to efficiently monitor the inventory movement and sales data in an effective and systematic manner. Through such measures we can make appropriate operational adjustments in response to market conditions and customer needs and forecast future demands more accurately. Our commitment to adopting and developing an advanced operations system helps us more accurately forecast demands, which contributed to better managed inventory, product quality and profitability. We believe our advanced business intelligence system has allowed us to expand efficiently and enabled us to better apply targeted marketing strategy based on customer's purchase record and identify cross-selling opportunities.

For the years ended December 31, 2015, 2016 and 2017, our revenue generated from beverage solutions business was HK\$634.7 million, HK\$639.2 million and HK\$711.3 million, respectively, which accounted for approximately 75.7%, 75.2% and 74.5% of our total revenue for the same periods, respectively. In addition, we sold food products, which included frozen meat and frozen processed food. For the years ended December 31, 2015,

BUSINESS

2016 and 2017, our revenue generated from food products business was HK\$203.4 million, HK\$210.5 million and HK\$243.3 million, respectively, which accounted for approximately 24.3%, 24.8% and 25.5% of our total revenue for the same periods, respectively.

OUR COMPETITIVE STRENGTHS

We are a leading and trusted integrated B2B coffee and black tea solutions provider in Hong Kong, Macau and the PRC with 85 years of heritage.

We are a leading integrated B2B coffee and black tea solutions provider in Hong Kong, Macau and the PRC with 85 years of heritage. Leveraging off our wealth of market knowledge and product know-how, we provide our customers a one-stop service starting from market analysis and recipe development through sourcing, production, marketing and after sales services. Our origin could be traced to an outlet providing coffee roasting and trading of coffee and tea in 1932. Since then, we have grown into a well-trusted brand in Hong Kong, and along the way, developed a stable and diverse group of customers that include well-known industry food and beverage providers, including the franchised business of McDonald's in the PRC and Hong Kong, Yoshinoya, 7-Eleven, Café de Coral, Fairwood, Tsui Wah, Tai Hing and Spaghetti House. Together with our customers, we catered to generations of end consumers in our region and successfully evolved to meet changing consumer tastes. In addition, in the PRC, we have established a stable beverage solutions business, which we believe has good growth potential as reflected in our financial results for the year ended December 31, 2017.

According to Frost & Sullivan, we were the largest B2B coffee and black tea solutions provider in Hong Kong in 2016 with 24.5% of the market share in terms of B2B revenue, and the third and fourth largest B2B coffee and black tea solutions provider in Macau and the PRC, respectively, in 2016 in terms of B2B revenue. In addition, in 2016, we were the largest Sri Lanka tea importer in terms of volume in Hong Kong and the third-largest Sri Lanka tea importer in terms of volume in the PRC. For more detailed market rankings, please refer to the section headed "Industry Overview" in this prospectus. In addition, according to Frost & Sullivan, we have grown into a well-trusted brand in Hong Kong, Macau and the PRC providing one-stop coffee and tea solutions to commercial customers that cover the entire coffee and tea procurement, processing and distribution value chain. We have also been awarded the Hong Kong top brand mark since 2009 and served as the official coffee and tea provider at 2008 Beijing Olympics, 2010 Guangzhou Asia Games and 2011 Shenzhen Summer Universiade Games. According to the survey conducted by Frost & Sullivan, we are the most well-recognized top quality coffee and black tea brand among restaurants in Hong Kong.

Over the years, we have also implemented various measures that we believe contributed to the advancement of the coffee and black tea culture in Hong Kong. We began to provide coffee machines, including the introduction of Rex-Royal coffee machines, along with our coffee products in 2003 to fast food chains and Cha Chaan Teng in Hong Kong to serve fresh brewed coffee and espresso, which created consistently better tasting coffee products for end-users in such venues. At the same time, we are the distributor of Lipton yellow label tea in Hong Kong and began to exclusively import a renowned luxurious French syrup

BUSINESS

brand, Monin, for coffee and tea beverages in Hong Kong and Macau. Since then, we have successfully developed Monin products into a widely-accepted beverage supplement and paved the path for introduction of other Monin products, such as puree and frappe. We believe such market measures not only elevated the service standard for coffee and tea beverages in fast food chains and Cha Chaan Teng in Hong Kong, but also enhanced our brand recognition amongst our customers and/or their end-users, which in turn, strengthened our business growth and leading market position.

We have a strong beverage customizing capability and an established food products business supported by a worldwide sourcing network.

Our leading market position is attributable to our strong ability to customize integrated coffee and tea beverage solutions for our customers, and at the same time, we have an established frozen meat and frozen processed food business. We provide a total solution for coffee and black tea, with an expertise on Hong Kong-style milk tea. As a trusted partner, we actively approach our customers to form solutions that transfer their beverage concepts into customized products that suit the tastes of targeted consumers economically. Moreover, we remain committed to ensuring that solutions we form with our customers have the desired results through a comprehensive after sales service that includes 24-hour repair and maintenance service for coffee machines in Hong Kong and Macau. We pride ourselves in being a part of our customers' menu management process, and we believe our success is based on our ability to provide a full scale service covering the entire coffee and tea processing and distribution value chain to bring our customers' beverage concepts to market. We import frozen meat products, mainly beef, pork, poultry and lamb from international meat suppliers located in countries including Brazil, New Zealand, Japan, United States, Thailand and the PRC. We follow market development closely to provide cost-competitive frozen meat for our major customers, who are primarily wholesalers catering to fast food chains and Cha Chaan Teng. We have on average over four years of experience serving our major frozen meat product customers. We believe such stable business relationship is built on a commitment and ability to continuously procure and provide quality products, according to our customers' demand at competitive prices.

Our one-stop beverage solutions service starts with a good understanding of our customer's needs, which we believe is fundamental to our success. As such, we regularly engage our customers to discuss the latest market preferences and best practices that we assemble through our diverse sales and distribution venues, and to collect their feedback on the existing products and their new beverage concepts. We believe such two-way dialogue has helped us better understand our customer's needs and have built strong customer relationships. In addition, we believe our well-established connections to renowned suppliers have contributed to our success as an integrated coffee and tea solutions provider. Through our suppliers, we have access to a comprehensive portfolio of quality-assured materials from different continents across various climate zones.

We have on average over ten years of procurement experience with our major suppliers, and as a result of such long established relationship, we believe we are able to order a specified amount of raw materials at designated delivery times under competitive prices, thus permitting us to quickly formulate the desired solutions according to our

BUSINESS

customer's needs economically. Moreover, through close collaboration and frequent communication with our major suppliers, we believe we have been able to better forecast the raw material price changes and manage procurement costs. In turn, such value-added service helps our customers and us better manage financial risk associated with raw material price changes. At the product execution stage, leveraging off our rich roasting, blending and mixing experience and adoption of automated production system, we are able to consistently deliver quality-assured tailor-made products in mass volumes. We have the ability to simultaneously produce different products packaged for wholesale and/or assembling them in retail ready portions to fulfill the demands of our diverse customer base. Moreover, to make sure our proposed coffee and tea solutions can be implemented consistently with the desired effect, we not only help our customers form the product but also provide the essential coffee equipment and design the details of the preparation techniques. Also, we believe we were the first to establish an automated coffee production line in Hong Kong, and we believe our investment has enhanced our ability to bring product of great quality to the market.

Building on our strong customizing capability, we regularly participate in our customer's menu development process. During the Track Record Period, we collaborated with renowned fast food chains and other well-known food and beverage service providers in introducing customized beverages of various flavors to be served in different seasons. Much of such collaboration was with existing customers with whom we have well-established relationship. At the same time, our strong reputation and commitment to excellence has helped us develop new clients and expand our customer base, including renowned retail brands. In turn, our close collaboration with new and existing customers allows us to gain valuable market knowledge, and the proven success of such products has also strengthened our customer loyalty. Moreover, through this scalable business model, we have successfully expanded our operations and built a stable and diverse customer base.

We have a stable and diversified customer base supported by a well-established multi-channel distribution network with proven ability to capture new markets.

Our ability to consistently customize beverage solutions has helped us build a stable and diverse customer base. We deliver to fast food chains and Cha Chaan Teng with voluminous orders that satisfy the demand of the mass market, and serve airlines and luxury hotels that demand for specialized products to cater to the tastes of a niche segment. Supported by a pre-delivery system, a well-established logistics team, and supplemented by distributors with local market knowledge, we have been able to maintain a delivery service of within 24 hours to approximately 750 delivery points in Hong Kong on a daily basis. We believe we are one of the few integrated B2B coffee and black tea solutions providers in Hong Kong, that have the ability to consistently meet the scaled demands of fast food chains and Cha Chaan Teng, and at the same time, bring quality solutions to customers that serve consumer markets with specialized demand. In particular, we have on average of over ten years of experience working with our key customers, which demand for new beverage solutions frequently. Our close collaboration with key customers not only contributed to our business growth but also fed into a positive cycle of market knowledge accumulation.

BUSINESS

Our diverse customer base gives us a multi-channel distribution network that can reach approximately 60% of the food outlets in Hong Kong in 2016, which include up to approximately 77.6%, 70.3% and 78.7% market coverage of fast food stores, Cha Chaan Tengs and cafes, respectively. Such extensive market exposure coupled with our dedication to customer service keep us abreast of the latest consumer preferences across market segments. According to the survey conducted by Frost & Sullivan, we are the most well-recognized top quality coffee and black tea brand among restaurants in Hong Kong. At the same time, we believe such valuable market knowledge differentiates us from most of our competitors as we are one of few integrated B2B coffee and black tea solutions providers with a distribution network that covers a diverse base of food outlets. Moreover, leveraging off our established distribution network for beverage products, we have expanded our frozen processed food offering to well-established fast food chains and Cha Chaan Teng to which we previously only provided beverage products. We believe our success in cross-selling food products to such customers is contributed by our unwavering commitment to product quality and better understanding of the frozen processed food market. In addition, this illustrates our progress as a comprehensive food and beverage service provider. We believe our strong reputation has helped us successfully expand our offerings to our customers, and we will continue to seek such cross-selling opportunity to further grow our business.

We have a strong track record that is enhanced by integration of advanced quality control and data analysis system that also facilitates business development.

In 2017, coffee sold by us can be made into 253.2 million to 337.7 million cups of coffee per year and between 693,800 to 925,100 cups of coffee per day (assuming nine to 12 grams of coffee is applied to produce each cup), while tea sold by us can be made into 302.4 million to 403.2 million cups of milk tea per year and between 828,500 to 1,104,600 cups of milk tea per day (assuming nine to 12 grams of tea is applied to produce each cup of milk tea). As we provide products that are consumed by a sizable population on a daily basis, we embrace such responsibility with an unwavering commitment to food safety and consistent service quality. Our stringent quality control process starts with sourcing from suppliers with internationally-accredited quality certifications, and journeys through our operations in Hong Kong and the PRC under the strict commitment to internationally recognized standards, including HACCP, ISO 9001:2008, ISO 14001:2004 and ISO 22000:2005. Moreover, we have installed automated and digitized systems that monitor and instantly record production data to ensure full traceability. We also supplement our internationally accredited production process with scientific tests and online monitoring to further ensure our product quality. We believe such customer recognition and certifications and initiatives signify our commitment to food safety and consistent service quality, and have been the foundation to our strong track record.

We have adopted an integrated business intelligence system that connects different segments of our operation. Through such system, we can efficiently coordinate our production planning, supply chain management, business analysis management and financial reporting management. Timely access to the daily inventory and sales data allows our management to efficiently monitor the inventory movement and sales data in an

BUSINESS

effective and systematic manner. Through such measures we can make appropriate operational adjustments in response to market conditions and customer needs and forecast future demands more accurately.

Our commitment to adopting and developing an advanced operations system helps us more accurately forecast demands, which contributed to better managed inventory, product quality and profitability. We have amassed a comprehensive database of food and beverage outlets in Hong Kong which is officially updated annually, while our sales personnel receive up-to-date sales data through our internal sales software, QlikView. We generally update relevant sales data on QlikView on a daily basis. Such system allows us to perform customized sales analysis, which we then utilize to adjust purchasing decisions and product offering. Furthermore, such analysis allows our sales personnel to receive up-to-date market data which in turn allows them to engage in targeted sales efforts, including to identify cross-selling opportunities of food products to existing customers and develop new customers. We believe our advanced business intelligence system has allowed us to expand efficiently and enabled us to better apply targeted marketing strategy based on customer's purchase record and identify cross-selling opportunities.

We have an experienced and high caliber management team with valuable know-how supported by full adoption of modern management system.

We have an experienced and dedicated management team led by our chairman and executive Director, Mr. Wong. Mr. Wong is the third generation of our founder and has over 39 years of management and industrial experience in the food and beverage industry. Mr. Wong is the architect behind Tsit Wing's production modernization that included installation of automated equipment, and capacity expansion that was instrumental to our business growth. Mr. Wong's leadership and long-term vision was instrumental to our development in the past and has laid a strong foundation to our future expansion. Our other executive Directors, Mr. Wu Kam On Keith and Ms. Fan Yee Man, also have twelve and six years of experience in the food and beverage solutions industry, respectively. Mr. Wu, who joined our Group in 2005 as a management accountant of COFE, had held various financial and management positions within our Group before he was promoted as an executive Director and the group chief operation officer of our Company. Ms. Fan, who has been in our Group since 2012, had served as the financial controller of COFE and the group financial controller before she was promoted as an executive Director and the group chief financial officer of our Company.

Our experienced senior management team comprises of industry experts with valuable know-how and more than ten years of experience in the food and beverage industry on average. They have developed extensive experience in raw material procurement, product development and distribution management, which has all contributed to better operations and cost management. For further details of our Directors' and senior management teams' biographies, please refer to the section headed "Directors and Senior Management" in this prospectus. Our senior management is supported by staffs with strong local market knowledge and expertise. Our experienced senior management team has played a key role in leading the operation and development strategy of our Group and provided us with deep

BUSINESS

industry and operation knowledge. Their management capability and cohesiveness, supported by a strong execution team and management system, will continue to help us deliver sustainable growth in the future.

OUR BUSINESS STRATEGIES

Further strengthen our leading position in the integrated B2B coffee and black tea solutions market in Hong Kong, deepen our penetration in the PRC, expand our business in Southeast Asia, and enhance our brand recognition and awareness.

We seek to strengthen our leading position as an integrated B2B coffee and black tea solutions provider in Hong Kong, Macau and the PRC. According to Frost & Sullivan, from 2012 to 2016, B2B coffee and black tea products market in Hong Kong has expanded from HK\$927.0 million to HK\$1,105.5 million, representing a CAGR of 4.5%, and is expected to continue to grow from HK\$1,159.0 million in 2017 to HK\$1,363.8 million in 2021 with a CAGR of 4.2%. We believe that a commitment to improve our solution offering capabilities is crucial to maintaining our leading market position. As such, we will continue to leverage off our global sourcing capability and further invest in our market-oriented product development efforts. At the same time, leveraging off the wealth of industry knowledge that we have accumulated and continue to garner in our day-to-day operations, we remain committed to building a know-how data base that will help formulate integrated coffee and tea solutions even more efficiently, and in turn, improve the quality of our service, in the future. We will also continue to closely collaborate with our customers and assist them in developing effective ways to collect the preferences of the local consumers and to come up with trend setting products. We have successfully introduced new products and flavors such as seasonal drink series for renowned customers in the past and aim to continue to do so in the future. We also plan to expand our sales channels through increased coverage of supermarkets, luxury hotels, fast food chains and airlines. We intend to further enhance our brand recognition and awareness by devoting more resources in our promotional and marketing activities, including traditional advertising channels, print and television media and in-store promotional campaigns, as well as social network activities and joint sponsored events. We believe such marketing strategies are critical and essential to our future success. Furthermore, to support our operational growth, we intend to enhance our logistics capability by expanding our logistics team, and more closely collaborate with reliable third party logistics providers with whom we have established relationships.

We also seek to deepen our market penetration and enhance our brand recognition and awareness in the PRC. We intend to expand our sales channels that we believe have relatively higher growth potential, particularly the Pearl River Delta in the near term and the Yangtze River Delta in the long-run. During the Track Record Period, our sales efforts mainly focused in the first and second tier cities in eastern and southern China, such as Shanghai, Beijing, Hangzhou, Guangzhou, Shenzhen and Dongguan. Going forward, we seek to continue to expand in these major cities while further grow our sales and distribution network into other major cities with strong growth potential. We also plan to leverage our sales team and our sales offices in the PRC to help expand our sales network and build our understanding of local markets. In particular, through an enlarged sales

BUSINESS

team, we plan to grow our sales of Chinese tea to restaurants in the PRC and seek cross-selling opportunities of our other products. Moreover, we will continue to enhance our distribution ability in the PRC by seeking strategic cooperation opportunities with local distributors and enhance our logistics capabilities. At the same time we plan to expand our business in Southeast Asia, which we believe is a region which demands for coffee and tea products. For further details, please refer to the section headed “Future Plans and Use of Proceeds — Use of Proceeds” in this prospectus.

Continue to strengthen our frozen meat and frozen processed food products business and expand our product offerings.

We intend to actively expand our product offerings to provide the convenience of one-stop purchasing for our customers. With a more comprehensive portfolio of products, including food products, we seek to expand our sales channel to food and beverage providers. In particular, we seek to strengthen our relationship with our existing frozen meat and frozen processed food customers by continuing to source quality frozen meat and frozen processed food products that meet their needs, and through an enhanced understanding of the frozen meat and frozen processed food market, develop new customers. We also aim to further expand our business in the frozen processed food markets, enhance our ability to procure customized frozen processed food and integrate our frozen meat and frozen processed food products into our customer’s central kitchen. Further, leveraging off leading market position and well-established distribution network, we will continue to seek cross-selling opportunities in the frozen meat and frozen processed food and other food product markets in Hong Kong and the PRC.

Building on our experience of successfully offering food products to well-established food and beverage service providers, we intend to continue to work with existing and potential new customers to further explore such cross-selling opportunities. For example, we entered into a strategic cooperation agreement with NH Foods, a leading food provider with operations in about 90 locations in 19 countries and regions, in July 2017 to jointly develop the food products market in Hong Kong, Macau and the PRC. We believe that our market knowledge combined with NH Foods’s abundant resources positions us well to develop targeted markets. We also seek to cooperate with our strategic partner, NH Foods, to provide tailor-made frozen meat and processed food products to satisfy the needs of our customers. We intend to engage NH Foods as consultant as they have the expertise to share the knowledge and know-how of conducting processing food products business, including slicing, cutting, marinating and packaging procedures of raw meat to meet our customer’s specification. In addition, leveraging off our experience in providing frozen meat and frozen processed food, we plan to further develop frozen food processing and other business, in particular, potential future business or share acquisitions, joint ventures or other strategic arrangement with entities with (a) product portfolios that include meat, flour and/or dairy products and meet the demand of our customers, and (b) distribution channels to food outlets such as Chinese restaurants and other targeted customers that are currently not covered by our existing distribution network, including an established business to business distribution network, that allows us to enlarge and enhance our customer base, to expand

BUSINESS

and enhance our product portfolio and to deepen our market penetration. For further details, please refer to the section headed “Future Plans and Use of Proceeds — Use of Proceeds” in this prospectus.

Continue to strengthen our sourcing capability and strengthen our vendor selection process.

We seek to continue to strengthen both the breadth and the depth of our worldwide sourcing network by engaging more globally recognized suppliers while deepening our relationship with our existing supply channels. We strive to identify more materials that could be applied to our customized solutions and allow us to offer a comprehensive portfolio of products. Such measures include building a larger portfolio of milk product sources that encompass more variety of milk concentrates to be applied to our customized coffee and tea solutions. We will also continue to monitor market trend and seek raw materials that can be applied to form food and beverage flavors that best meet latest consumer preferences. Furthermore, we will continue to source trading goods that can effectively expand our product portfolio to promote one-stop purchasing experience or cater for specific needs of our customers.

In addition, we seek to maintain our long-term relationship with trusted suppliers while exploring new raw material sources and exporters of trading goods. Through such measures, we strive to continue to build a healthy pool of suppliers that can ensure stable and quality supply at competitive price. Moreover, we intend to strengthen our vendor selection process to ensure only qualified new suppliers are engaged and existing suppliers are evaluated regularly. In particular, we strive to enhance our supplier selection through an assessment that includes a detailed review of raw material quality as well as price competitiveness and service stability. Furthermore, leveraging off our successful experience in securing exclusive distribution agreements with our strategic syrup supplier of renowned brands, Monin, and coffee machine suppliers, Rex-Royal, we seek to further explore opportunities to source from well-established brands, especially under exclusive distribution arrangements, to enhance our product offerings.

Seek to upgrade our production facilities and further enhance our production capabilities.

As part of our effort to continuously provide optimal services to our customers, we intend to upgrade our production facilities and enhance our production capabilities. In particular, to ensure that we can meet different demands from our diverse customer base, we intend to (i) acquire new coffee machines for our customers, (ii) upgrade the coffee roasters in our Hong Kong facility, (iii) set up a warehouse and renovate facilities, and (iv) acquire additional machinery including equipment used to detect foreign objects, equipment for better working environment for our employees and packaging equipment with functions equipped to cater to small-size packaging for tea (which is not interchangeable for coffee) to increase the products portfolio of our Company. We split our production capacities in the PRC and in Hong Kong to diversify production risk and to better utilize our resources and enhance our processing capability by adding more retail packaging capability. In addition, we intend to establish a separate frozen food processing facility equipped with frozen food processing lines and relevant machinery to enhance our ability to serve more diverse customers, including direct sales to restaurants and cafes, as well as deploy a cold storage

BUSINESS

truck in Hong Kong to complement our frozen food business. For further details regarding our expansion plan, please refer to the sections headed “Financial Information — Capital Expenditures — Planned Capital Expenditures” and “Future Plans and Use of Proceeds” in this prospectus. Meanwhile, we will continue to advance our quality control equipment and warehouse capabilities to support the expansion of our production. We also intend to further upgrade our production capacity in Hong Kong as our key machines for processing our coffee and tea products in our production facility in Hong Kong have on average been implemented for over ten years.

OUR BRAND/PHILOSOPHY

We are a well-recognized and trusted coffee and tea solutions brand with an established food products business. According to the survey conducted by Frost & Sullivan, we are the most well-recognized top quality coffee and black tea brand among restaurants in Hong Kong. Operating under the “Tsit Wing” brand, we are principally engaged in the provision of integrated B2B coffee and black tea solutions, providing a one-stop service for our commercial customers that cover marketing analysis, recipe development, sourcing, production, marketing and after sales services which include regular customer training and equipment maintenance. In addition, we have an established B2B food products business, which encompass sales of frozen meat and frozen processed food.

The table below sets out a breakdown of our revenue categorized by business segments and by geographical sales during the Track Record Period.

	Year ended December 31,					
	2015		2016		2017	
	(HK\$'000)	% of total	(HK\$'000)	% of total	(HK\$'000)	% of total
Beverage Solutions	634,723	75.7%	639,175	75.2%	711,349	74.5%
— Hong Kong	418,048	49.9%	422,548	49.7%	458,610	48.0%
— PRC	196,771	23.5%	199,822	23.5%	234,387	24.6%
— Macau	12,067	1.4%	11,387	1.3%	11,153	1.2%
— Others ⁽¹⁾	7,837	0.9%	5,418	0.7%	7,199	0.7%
Food Products	203,429	24.3%	210,545	24.8%	243,261	25.5%
— Hong Kong	194,670	23.2%	206,072	24.3%	238,743	25.0%
— PRC	8,759	1.1%	4,473	0.5%	4,518	0.5%
Total	838,152	100%	849,720	100%	954,610	100%

Note:

- Others include revenue derived from sales in Australia, Canada, Malaysia, Philippines and Taiwan.

BUSINESS

Beverage Solutions

We are a leading integrated B2B coffee and black tea solutions provider in Hong Kong, Macau and the PRC with 85-years of heritage. Operating under “customer first”, “solution driven” principle, we provide our services and products to a stable and diverse group of food and beverage service providers, including fast food chains, Cha Chaan Tengs, luxury hotels, cafes and restaurants, and leading fast food industry participants, including the franchised business of McDonald’s in the PRC and Hong Kong, Yoshinoya, 7-Eleven, Café de Coral, Fairwood, Tsui Wah, Tai Hing and Spaghetti House. During the Track Record Period, we successfully introduced approximately 300 new customized products with our customers. Such customized products were sold to approximately 120 customers/distributors packaged in servings that ranged from 2.5 grams per pack to 20 kilograms per box, including a coffee product we jointly developed with our major customer, a leading fast food chain. During the product development process, we (i) commenced by preparing an update on the relevant coffee bean market and raw material sources (of various kinds of coffee by their origin, characteristics and grading) and engaged in discussions with the customer on the product concepts, (ii) created products of various tastes and organized product tastings for the customer, and confirmed the product formulation with the customer, (iii) designed the production and packaging (for both in house serving and retail sales) and detailed product preparation procedure, and (iv) participated in the customer’s marketing campaign for such products. Together with our customers, we have catered to generations of end users and successfully evolved to meet the changing tastes of end-users. We pride ourselves in being part of our customers’ menu management process and in our ability to constantly deliver customized solutions in a timely manner.

As a trusted partner, we actively offer our customer quality assured solutions that efficiently complete the “concept to market” process regularly. Leveraging off our expertise and our experienced employees, including our in-house trained coffee baristas and tea masters, we not only help formulate the flavor of the products, but also regularly provide ancillary services including, market research and feasibility studies, design and development of marketing strategies that fit the needs of our customers. During the process of forming such solutions, we not only leverage over our past experience but have also been able to tap into new resources, for instance drawing from raw materials which we did not regularly procure in the past. We believe our ability to successfully provide such services is a result of a combination of our knowledge base and our commitment to stay abreast of the latest market information.

In addition, to ensure the feasibility of our proposed solutions, our finance, marketing, and production departments work closely to ensure that new products can be brought to market in an economical and timely manner. The criteria considered include an analysis on the sourcing of raw materials, production capacity required, technology and equipment to conduct mass production of new product and the costs associated. Moreover, to ensure our proposed solutions can be implemented consistently with the desired result, we provide our customers with the essential coffee equipment and design the details of the preparation techniques.

BUSINESS

Our vision is to become a “world-class integrated food and beverages services provider”, and we are constantly in search of means to enhance our solutions offering capability and for horizontal business expansion. We continue to strengthen both the breadth and the depth of our global sourcing network by engaging more globally recognized suppliers while deepening our relationship with our existing supply channels. At the same time, leveraging off the wealth of industry knowledge that we have accumulated and continue to garner in our day-to-day operations, we remain committed to building a know-how data base that will help formulate integrated coffee and tea solutions even more efficiently, and in turn, improve the quality of our service, in the future.

Over the years, we have also implemented measures that we believe contributed to the advancement of the coffee and tea culture in Hong Kong. We began to provide coffee machines along with our coffee products in 2003 to fast food chains and Cha Chaan Tengs in Hong Kong to serve fresh brewed coffee and espresso, which created consistently better tasting coffee products for end-users in such venues. At the same time, we began to import a renowned luxurious French syrup brand, Monin, for coffee and tea beverages in Hong Kong. Since then, we have successfully developed Monin products into a widely-accepted beverage supplement and paved the path for introduction of other Monin products, such as puree and frappe. We believe we were amongst the first to introduce these market measures, and we believe such market measures not only elevated the service standard for coffee and tea beverages in fast food chains and Cha Chaan Teng in Hong Kong, but also enhanced our brand recognition amongst our customers and/or their end-users, which in turn, strengthened our business growth and leading market position.

Value Chain of the Coffee and Tea Products Market

Coffee and tea products market flows from producers to consumers. Producers such as individual farmers or plantation groups grow coffee beans and tea leaves and sell the raw products to processors. After processing, such products are then distributed to food and beverage serving establishments and fast moving consumer goods through wholesale channels. Consumers then purchase coffee or tea products through such retail outlets.

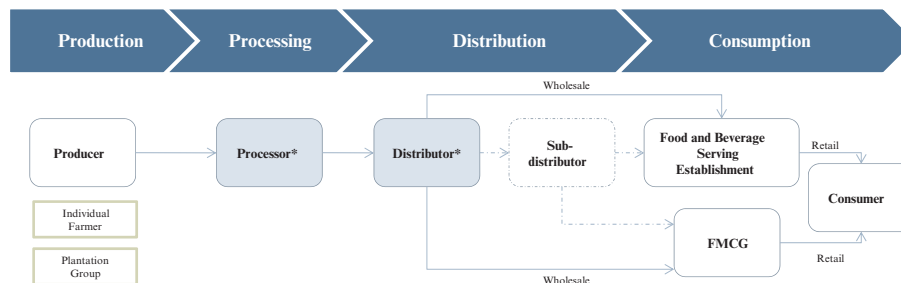

* Our Company is involved in the process.

BUSINESS

Our beverage solutions business model

We believe our success is built on our proactive approach towards providing customized beverage solutions in a timely manner. Such solutions are formed based on a one-stop customer focused, solutions driven business model executed in five closely-knit operational modules that reinforce each other and are connected by our ERP system. For further details of our ERP system, please refer to “Business — Business Intelligence and Information Technology” in this section.

Our five operational modules include (i) menu management and recipe development, (ii) strong global sourcing network, (iii) automated product execution, (iv) sophisticated distribution system for diverse customers, and (v) comprehensive customer services, as illustrated below.



* *Our business operation is fully integrated and connected by our ERP system. For further details, please refer to “Business — Business Intelligence and Information Technology” in this section.*

BUSINESS

1. Forming Integrated Solutions*Tailor-made menu management and recipe development*

A good understanding of our customer's needs is fundamental to our success. As such, we regularly engage with our customers to discuss the latest market preferences and best practices that we assemble through our multi-channel sales and distribution network, and to collect their feedback on the existing products and their new beverage concepts. When appropriate, we would take the initiative to introduce to our customers new ingredients and/or raw materials that could be applied to their new products. We have successfully and consistently introduced new products through such measures over the Track Record Period. We also believe such two-way dialogues have helped us better understand our customer's needs and built strong customer relationships. We take pride in the trust our customers place in us and our ability to be part of their menu management process.

Our integrated solutions cover the entire "concept to market" process. We not only help our customers form the product but also provide the essential coffee equipment and design the details of the preparation techniques to ensure a consistent end user experience. Such measures include recommending appropriate machinery and preparation steps (down to the minute) to be adopted when applying such machinery in an effort to optimize the quality of the end product and end user experience. In addition, leveraging off our knowledge of the local consumer market, we provide our marketing input or engage in joint promotions with our customers. We believe our strength in this area lies with our good grasp of how product characters connect with the latest consumer taste. In turn, we believe our strong handle over product character lies in our input to the product formation in the initial stages of our customers' menu management/product development process. We pride ourselves in the ability to provide such value-added input, and we believe such close collaboration has contributed to us building a diverse and stable portfolio of customers.

2. Strong Global Sourcing*Access to a global inventory through our major suppliers*

We have a stable sourcing network that includes many globally renowned major suppliers with whom we have over ten years of relationship, and we will continue to enhance the breadth and depth of our supply network by engaging more globally recognized suppliers while deepening our relationship with our existing supply channels.

Through such suppliers, we have access to quality raw materials from different continents across various climate zones at designated delivery times at competitive prices. Leveraging off such quality-assured raw materials, we constantly introduce customized beverages of various flavors served in different seasons that could be readily packaged for wholesale and/or assembled in retail portions to fulfill the demands of our diverse customer base. Such measures at times encompass blending niche raw materials in customized portions and packaging them in customized portions

BUSINESS

to achieve the anticipated taste. We believe our ability to provide such service illustrates our strong industry knowledge. In addition, through close collaboration and frequent communication with our major suppliers, we believe we have been able to better forecast the raw material price changes and manage procurement costs. In turn, such value-added service helps our customers and us better manage financial risk associated with raw material price changes.

3. Automated Product Execution*Automated production capability encompassing stringent quality control system*

To ensure that we are able to efficiently bring customized beverage products of consistent quality to our customers, we have established an automated production system encompassing a comprehensive set of automated production facilities. Through the automated features offered by such facilities, we can deliver tailor-made products in mass volumes to industry leading food and beverage providers that are known for enforcing strict food quality requirements.

We have also implemented stringent quality control procedures throughout our production and delivery process. We installed automated and digitized systems to ensure product traceability and minimize offline manual operation, and our operations in Hong Kong and the PRC have received quality assurance recognitions from internationally recognized quality assessment authorities, such as HACCP and ISO 9001:2008, ISO 14001:2004 and ISO 22000:2005.

4. Sophisticated Distribution System for Diverse Customers*Well-established logistics system with a delivery capability of within 24 hours for a wide-range of customer in Hong Kong*

We face the challenge of delivering products to approximately 750 delivery points in Hong Kong on a daily basis. Moreover, our diverse customer base comes the need to be able to simultaneously provide products packaged for wholesale volumes and retail ready portions in a timely manner. We overcame such challenge by adopting an operating system that produces meticulous pre-delivery planning from our warehouses, which is then double-checked by our experienced personnel before delivery. We then rely on our fleet of trucks in Hong Kong and cooperate with third party logistics providers to deliver our products on time. In the PRC, we collaborate with reputable third party logistics providers to ensure that orders we received are fulfilled on time.

Our well-established logistics system helps us ensure delivery of quality assured products in a timely manner, and along the way, develop a stable and diverse customer base that includes mass market customers (such as fast food chains, Cha Chaan Teng and cafes) and niche customers (such as luxury hotels, airlines and amusement parks). In turn, such extensive market exposure keeps us abreast of the latest consumer preferences across market segments and enhances our industry knowledge.

BUSINESS

5. Comprehensive Customer Service*A dedicated and resourceful support team*

Building on our success as an integrated B2B coffee and tea solutions provider, we continuously seek ways to enhance our services and strengthen our ability to provide a comprehensive set of solutions. As part of our effort to offer a complete set of offerings, we entered into the frozen meat market in Hong Kong and the PRC in 2013 and the frozen processed food business in Hong Kong in 2015 and in the PRC in 2016.

Our sales team stays abreast of our customers' needs and regularly provides ancillary services, such as product education, equipment knowledge update, and customer training on serving, brewing and preparation techniques, to ensure an optimized end user experience. We provide such services to our customers on a regular basis, and more frequently when new measures that we consider to be relevant to our customers are introduced to market. We believe such regular ancillary services show that we are committed to bringing not only quality products to our customers but also an optimized experience for the end users of our products. We also apply the market knowledge we garner from our communication with customers to form integrated solutions, thus forming a virtuous cycle of knowledge reinforcement. At the same time, we are committed to exploring measures that can improve end user experience. Such measures include partnering with renowned equipment providers and conducting market-research on latest consumer preferences, which we regularly provide to our diverse customer base. We have also established a customer service center that provides after sales support, including a 24-hour assistance on repair and maintenance of coffee machines.

A close interaction with market players provides us with timely insight in evolving consumer preferences. Such experience allows us to add to our wealth of market knowledge and product know-how garnered over our long history, which in turn, strengthens our position as a leading B2B coffee and tea solutions provider.

BUSINESS

Food Products

During the Track Record Period, we derived a substantial portion of our revenue from the sales of food products in Hong Kong and the PRC. Our food products include frozen meat and frozen processed food. We entered the frozen meat market through an acquisition by Whole Sun of the business and assets of a frozen meat supplier in Hong Kong in 2013. For further details, please refer to the section headed “History, Development and Corporate Structure — Our Corporate Development — (a) Major subsidiaries of TWIC — Whole Sun” in this prospectus. Leveraging off Whole Sun’s experience in the trading of frozen meat, we quickly extended our operation scope and established our presence in this new area of business operation. We engage in the trading and selling of imported frozen meat from countries including Brazil, New Zealand, Japan, United States, Thailand and the PRC, and we provide customized frozen processed food for our customers. We have a stable group of frozen meat customers, with whom on average we have over four years of business relationship. We believe such established relationship is built on our effort to follow market development closely and to provide cost-competitive frozen meat products to wholesalers who cater to fast food chains and Cha Chaan Teng. In addition, in 2015, as part of our horizontal expansion, we started trading and selling frozen processed food of renowned brands, and further launched our frozen processed food brand, “Papa Chef” in 2016 under OEM arrangement with a view to capturing the growth opportunities in the frozen processed food market. For further details regarding our OEM contractors, please refer to “Business — OEM Contractors” in this section. Going forward, we aim to provide frozen meat and frozen processed food to our customers and integrate such products into our customer’s central kitchen.

For the years ended December 31, 2015, 2016 and 2017, revenue generated from our food products business accounted for approximately 24.3%, 24.8% and 25.5% of our total revenue, respectively.

PRODUCTS

We offer a range of beverage and food products, mainly (i) roasted coffee, blended tea, and other beverage solutions products such as coffee machines and milk under our beverage solutions business, and (ii) frozen meat and frozen processed food under our food products business. During the Track Record Period, we also provided ice-cream products but disposed of such business in 2016. For further details regarding our disposed ice-cream business, please refer to “— Discontinued Operation” in this section.

BUSINESS

The following table sets out a breakdown of our revenue by product category:

	Year ended December 31,					
	2015		2016		2017	
	(HK\$'000)	% of total	(HK\$'000)	% of total	(HK\$'000)	% of total
Beverage Solutions	634,723	75.7%	639,175	75.2%	711,349	74.5%
— Coffee	194,654	23.2%	189,676	22.3%	198,033	20.7%
— Tea	188,738	22.5%	190,962	22.5%	228,676	24.0%
— Milk	80,082	9.6%	92,547	10.9%	97,009	10.2%
— Others						
— Groceries and others ⁽¹⁾	85,894	10.2%	81,338	9.6%	87,669	9.2%
— FMCG (i.e. All-In-One Beverage Products) and instant beverage mix ⁽²⁾	49,504	5.9%	48,339	5.7%	54,476	5.7%
— Monin products	24,826	3.0%	26,062	3.1%	28,418	3.0%
— Coffee and tea machines	11,025	1.3%	10,251	1.1%	17,068	1.7%
Food Products	203,429	24.3%	210,545	24.8%	243,261	25.5%
— Frozen meat	201,909	24.1%	202,211	23.8%	226,579	23.7%
— Frozen processed food	1,520	0.2%	8,334	1.0%	16,682	1.8%
Total	838,152	100%	849,720	100%	954,610	100%

Note:





1. Our groceries and others sales primarily include sales of Lipton yellow label tea.
2. Our retail sales equals to our FMCG sales, which amounted to approximately HK\$10.0 million, HK\$10.3 million and HK\$10.5 million for the years ended December 31, 2015, 2016 and 2017, respectively.

BUSINESS

Beverage solutions*Coffee products*

Save for a small amount of green coffee beans that we resell directly to our customers without further processing, substantially all of our coffee products are sold as roasted coffee beans, grinded coffee powder and drip coffee bag produced in our own production plants. Our regular house-blend coffee products are offered in a few distinct series with variations in origin, grading and aroma properties that cater to the diverse needs of our customers. We also collaborate closely with our customers to develop customized recipe and produce tailor-made coffee products in different forms, tastes and packaging.

Our major coffee products include the following:





Product	Description	Shelf Life	Illustrative Photo
Green Coffee Beans	We select coffee beans primarily from South American, African and Asian countries. Our packaging size ranges from 59 to 70 kg.	24 months	
Roasted Coffee Beans	We provide a wide array of roasted coffee beans. Packaging size ranges from 1 to 5 lbs. We generally serve these products together with the coffee machine.	12 months	
Coffee Powder	Our coffee powder packaging size ranges from 1 to 5 lbs.	12 months	
Drip Coffee Bag	We have newly launched Tsit Wing hand drip coffee — made from full coffee beans — to cater for coffee lovers who want to brew coffee themselves. Drip coffee is packed in 12 g sachets for catering and 10 g sachets for retail.	12 months	

BUSINESS

Tea products

Save for a small amount of processed tea leaves that we resell directly to our customers without further processing, the majority of our tea products are blended tea processed in our own production plants. We also collaborate closely with our customers to develop customized recipe and produce tailor-made tea products in different forms, tastes and packaging.

Our major tea products include the following:

Product	Description	Shelf Life	Illustrative Photo
Processed Tea Leaves	We source our tea leaves from Sri Lanka and only from sources recognized by the Sri Lanka Tea Board as well as from Indonesia and the PRC. We only choose partners who are awarded with ISO22000, HACCP certificates. Packaging size is 4 lbs to 50 lbs per pack.	24–36 months	 
Blended Tea Leaves	We blend different types of processed tea leaves together according to our customers' specifications. Packaging size is 6 ounce to 5 lbs per pack.	24 months	
Pyramid Tea Bag	We produce Chinese tea, Western tea and Japanese tea bags. For commercial customers, each pack contains 20 x 2 g tea bags. For retail, each pack contains 10 x 2.5 g tea bags.	24 months	 

“All-In-One Beverage Mix” products

Our “All-In-One Beverage Mix” products comprise of All-In-One coffee powder, tea and yuan yeung products which are produced in our own production plants and are primarily supplied to retail stores such as supermarkets and convenience stores.

Our major All-In-One beverage products include the following:

Product	Description	Shelf Life	Illustrative Photo
All-In-One beverage products	We provide All-In-One coffee and milk tea for catering and retail.	24 months	

BUSINESS

Other beverage solutions products

To provide the convenience of one-stop purchasing for our customers, we also market and sell, alongside with our roasted coffee and blended tea products, a variety of other beverage solutions products. We are the sole authorized agent of Monin products, a French luxury syrup brand, in Hong Kong and Macau, the distributor of Lipton yellow label tea in Hong Kong and the sole distributor of Rex-Royal coffee machines in Hong Kong and Macau.

The key terms of the standard distribution agreement for distribution of Monin products include:

- Term: Generally one and a half year, subject to a period of three years renewable by tacit agreement.
- Exclusivity: We are the sole authorized agent of Monin products in Hong Kong and Macau.
- Pricing: We are responsible for reporting sales conditions, price list and any modification of price of Monin products in the relevant territories.
- Payment terms: Generally, we settle the payment within 60 days after the dispatch from factory shown on the original invoice.
- Incentive scheme: We are incentivized to achieve progressive sales targets. The incentive scheme is typically in the form of discounts and allowance.
- Termination: Typically may be terminated (i) by either party in the event of the bankruptcy or judicial liquidation of either party; (ii) by one party upon the breach of agreement by the other; (iii) by Monin Asia K1 Sdn Bhd (“**Monin**”) in the event that we fail to fulfill at least 60% of the minimum quotas upon written notification of 90 days; or (iv) by either party by giving six months’ written notice.

We first entered into the distribution agreement with Monin in 2004, which included that the agreement is to be renewed by tacit agreement. We have renewed such agreement pursuant to such term since then. Our current distribution agreement with Monin is set to expire on December 31, 2020, and will be subject to renewal for a period of three years by tacit agreement.

BUSINESS

The key terms of the standard distribution agreement for distribution of Lipton yellow label tea in Hong Kong include:

- Term: We generally enter into agreement every six months.
- Payment terms: Generally 60 days from invoice date.
- Incentive scheme: We are incentivized to achieve progressive sales targets. The incentive scheme is typically in the form of credit notes.
- Pricing: Unit prices are typically specified, subject to change upon notice. However, all promotions and price changes initiated by us should be subject to the supplier's confirmation.

We first entered into a distribution agreement with Unilever Food Solutions Hong Kong (“**Unilever**”), a company that principally offers catering supplies such as tasty ingredients and recipes, over ten years ago. Our current distribution agreement with Unilever will expire on June 30, 2018 and we have commenced discussion with Unilever on the renewal of such agreement. We do not foresee any material obstacles to renewing the distribution agreement and expect to enter into a renewed agreement prior to the expiration of the existing agreement.



The key terms of the standard distribution agreement for distribution of Rex-Royal coffee machines include:

- Term: Two years.
- Exclusivity: We are the sole distributor of Rex-Royal coffee machines in Hong Kong and Macau.
- Payment terms: Generally 60 days after monthly statement.
- Pricing: Generally determined according to the listed prices, subject to adjustments made with reference to the quantity that we purchase.
- Termination: Typically may be terminated by either party by giving three months' advanced written notice.

We first entered into a distribution agreement with Rex-Royal in 1998. Our current distribution agreement with Rex-Royal will expire on December 31, 2018. We intend to commence discussion on the renewal of such agreement three months prior to the expiration.

BUSINESS

Our other beverage solutions products include the following:

Product	Description	Shelf Life	Illustrative Photo
Milk	Our milk products include evaporated and full cream milk.	12–18 months	
Monin Products	<i>Syrup:</i> Monin’s premium syrups are made with select ingredients and sugar to yield a highly concentrated and authentic flavor, offering exceptional versatility for creating specialty beverages.	18–36 months	
	<i>Puree:</i> Monin uses a unique formula with minimum 50% whole fruits, that could be applied to produce smoothies, cocktails, mocktails and other fruit-based recipes.	18–21 months	
	<i>Frappe:</i> Monin’s frappe is a versatile product which can complement other products to produce a variety of gustatory creations.	18 months	
Sugar	Our sugar products are packaged for wholesale.	24 months	
Coffee Machines/Tea Machines	We offer semi-automatic and fully-automatic capsule espresso machines manufactured by various manufacturers including the renowned Swiss brand, Rex-Royal. We also offer tea machines with automated functions.	N/A	

For further details regarding our OEM contractors, please refer to “Business — OEM Contractors” in this section.

BUSINESS

Food products*Frozen meat*

We re-sell our frozen meat products directly after we import such products and do not further process or repackage such frozen meat products before such products are picked up by other frozen meat suppliers and/or processors.

Our frozen meat products mainly include frozen beef, pork, lamb and poultry that are sold by our wholesale customers to fast food restaurants and Cha Chaan Teng. In addition to the frozen meat we regularly procure to meet the demand of our customers, we maintain a stable supply of specialty frozen meat products to ensure that products heavily demanded by end customers of our wholesale customers are readily available.

Frozen processed food

Our frozen processed food includes products that are ready to be consumed following a simple preparation process. We also customize frozen processed food according to our customers' needs. In addition to trading of frozen processed food under world-wide trusted brands to other wholesale suppliers and restaurants, we sell our OEM frozen processed food products under our brand "Papa Chef", which is a registered trademark in Hong Kong and the PRC. Our frozen processed food offering includes a wide variety of food products, such as roasted chicken, skewers, hash brown, breaded pork and seafood with a shelf life of 12 to 18 months.

PRODUCTION

We process our (i) roasted and ground coffee products, (ii) blended tea products and (iii) All-In-One coffee, tea and yuan yeung products (collectively referred to as "**All-In-One Beverage Mix**" products) at our own production facilities in Hong Kong and Dongguan, the PRC, while our milk and frozen processed food products are produced under OEM arrangement by contract manufacturers in Thailand, Lithuania and the PRC. We do not produce food products and only import and then directly re-sell such products. For further details regarding our OEM arrangement, please refer to "Business — OEM Contractors" in this section.

Production Facilities*Our automated production*

We have our own production facilities in Hong Kong and Dongguan, the PRC. Our production facilities are primarily equipped with automated production machinery and equipment integrated with a packaging process so that our products can be automatically packed into the designated containers. The fully automated production line allows simultaneous online monitoring, traceability by pack, instant storage of the production data and data analysis on the amount, roasting time and temperature. Upon setting the roasting time for the raw coffee beans, the large-scale roasting system completes the roasting process without human input while ensuring quality consistency during the

BUSINESS

process. We believe the implementation of such measures helped us build a strong track record and earned the trust of multinational corporations customers which have uncompromising quality standards.

Our production lines, production capacity and utilization in Hong Kong

As of the Latest Practicable Date, our production facility in Hong Kong is approximately 23,086 sq. feet and houses two roasted coffee production lines and two blended tea production lines in Hong Kong. Our production lines operate approximately ten hours per day and 5.5 days a week. As of December 31, 2017, we had 24 staff in our production team to operate and manage our production lines in Hong Kong.

The following table sets out our total production capacities and utilization rate of our facilities in Hong Kong during the Track Record Period:

Products	Year ended December 31,								
	2015			2016			2017		
	Designed production capacity ⁽¹⁾ (lbs)	Actual production volume ⁽²⁾ (lbs)	Utilization rate ⁽³⁾ (%)	Designed production capacity ⁽¹⁾ (lbs)	Actual production volume ⁽²⁾ (lbs)	Utilization rate ⁽³⁾ (%)	Designed production capacity ⁽¹⁾ (lbs)	Actual production volume ⁽²⁾ (lbs)	Utilization rate ⁽³⁾ (%)
Coffee	4,464,706	4,458,835	100%	4,464,706	4,630,628	104%	4,464,706	4,489,144	101%
Tea	3,970,588	3,829,797	96%	3,970,588	3,579,843	90%	3,970,588	3,432,554	86%

Notes:

1. The designed capacity is computed on the basis of the optimal production speed of various machines per hour for ten hours a day and 250 working days per calendar year, taking into account the cleaning of our coffee roasters once every week for half a day.
2. For the actual production volume of our products, factors considered include our human resources, the area of our production facilities and optimal production speed of our various production machinery and equipment.
3. Utilization rate is computed by dividing the actual production volume by the designed production capacity during the same period.

Our designed production capacity for coffee and tea products in Hong Kong was stable during the Track Record Period. The utilization rate for our coffee production line increased in 2016 due to steady growth in sales in Hong Kong, while the utilization rate for our tea and coffee production line decreased due to shifting of a portion of tea and coffee production to our PRC facility starting from late of 2015 and 2017 respectively. Our Hong Kong production, for both coffee and tea, was utilized to support sales in Hong Kong and overseas sales during the Track Record Period.

The existing designed packaging capacity at our Hong Kong production facility is approximately 8.5 million lbs per year and is currently utilized at 99% of its designed capacity.

BUSINESS

Our production lines, production capacity and utilization in Dongguan, the PRC

As of the Latest Practicable Date, our production facilities in Dongguan, the PRC is approximately 51,600 sq. feet, and houses two roasted coffee production lines, two blended tea production lines and four All-In-One beverage production lines in Dongguan, the PRC. As of December 31, 2017, we had 93 staff in our production team to operate and manage our production lines in Dongguan, the PRC.

The following table sets out our total production capacities and utilization rate of our facilities in Dongguan, the PRC during the Track Record Period:

Products	Year ended December 31,								
	2015			2016			2017		
	Designed production capacity ⁽¹⁾ (lbs)	Actual production volume ⁽²⁾ (lbs)	Utilization rate ⁽³⁾ (%)	Designed production capacity ⁽¹⁾ (lbs)	Actual production volume ⁽²⁾ (lbs)	Utilization rate ⁽³⁾ (%)	Designed production capacity ⁽¹⁾ (lbs)	Actual production volume ⁽²⁾ (lbs)	Utilization rate ⁽³⁾ (%)
Coffee	2,807,470	1,937,769	69%	2,807,470	1,956,274	70%	2,807,470	2,334,879	83%
Tea	2,028,604	1,739,927	86%	3,955,774 ⁽⁴⁾	2,481,254	63%	6,011,872 ⁽⁴⁾	3,183,282	53%
All-In-One	9,324,201	3,735,102	40%	9,324,201	3,406,916	37%	9,324,201	3,915,983	42%

Notes:

1. The designed capacity is computed on the basis of the optimal production speed of various machines per hour for ten hours a day and 250 working days per calendar year, taking into account the cleaning of our coffee roasters once every week for half a day.
2. For the actual production volume of our products, factors considered include our human resources, the area of our production facilities and optimal production speed of our various production machinery and equipment.
3. Utilization rate is computed by dividing the actual production volume by the designed production capacity during the same period.
4. We completed the construction of the tea processing plant in the PRC in 2015, but which only commenced operation in 2016. As a result, our designed tea production capacity in the PRC only increased in 2016. Our designed tea production capacity in the PRC further increased in 2017 because we installed additional packaging machines.

In the PRC, our designed production capacity for coffee products and All-In-One products was stable during the Track Record Period. Commencing in late 2016, we shifted a portion of our coffee production from our Hong Kong facility to the PRC, which in turn, led to the utilization rate increase in 2017. An insignificant portion of such products were used to meet our Hong Kong orders. Our All-In-One production line in the PRC supports our sales in the PRC and Hong Kong. Accordingly, our coffee and All-In-One production in the PRC was utilized mainly to serve our sales in the PRC while supporting our sales of these products in Hong Kong as well during the Track Record Period.

We completed the construction of tea processing plant in 2015, which commenced operation in 2016, which contributed to the material increase in tea production capacity in 2016 and further increase in 2017 due to installation of additional package line. Products

BUSINESS

produced by our tea production line in the PRC catered to the sales of our tea products in the PRC and also a portion of our tea products sales in Hong Kong during the Track Record Period.

The utilization rate at our PRC facilities is generally lower than the utilization rate of our Hong Kong facilities. The difference is mainly a result of: (i) establishing a production capacity in Dongguan that is larger than our immediate needs in preparation for future expansion, and (ii) our plan to gradually shift some of our production from Hong Kong to Dongguan as our production facilities in Hong Kong have been in high utilization and our major facilities in Hong Kong have on average been in use for over ten years. The decrease in the utilization rate of tea production lines in the PRC in 2016 and 2017 is primarily due to the increase in the designed production capacity of tea products as we completed construction of tea processing plant in 2015 which commenced operation in 2016 and installation of additional package machines in 2017.

The existing designed packaging capacity at our PRC facility is approximately 18.0 million lbs per year and is currently utilized at 45% of its designed capacity.

Our production machinery and equipment

All of our major production machinery and equipment are owned by us. Our coffee processing line utilizes coffee roasting system, coffee grinders, metal detector and automatic and semi-automatic packing machines that were imported from Brazil, United States, the PRC and Japan. Our tea blending line comprises of a tea blending system manufactured in Hong Kong and various automatic and semi-automatic packing machines that were manufactured in India and the PRC.

The following table sets out our major production machinery and equipment in our production facilities as of December 31, 2017:

Name of the Equipment	Purpose and Features of the Equipment	Country of Origin	Expected Useful Life Years	Average Remaining Useful Life Years
Coffee roasting system	Roasting of coffee beans	Brazil/United States	5–25	7
Tea blending system	Blending of tea leaves	India/Hong Kong	5–25	5
Metal detector	Detecting metallic substrates	Japan/PRC	4–10	4
Automatic and semi-automatic packing machines	Packaging	PRC	3–15	2

We conduct maintenance on the relevant machinery and equipment regularly, and replace or upgrade production equipment and machinery when necessary to enhance productivity or functionality. During the Track Record Period, we did not experience any material interruptions to our production process due to facilities or equipment failure.

BUSINESS

Production Process

Our production processes vary from product to product. The time for each step in the production process varies depending on the specific requirements of the product. Generally, once the raw materials enter into our respective production lines, it takes no more than two hours (depending on product type) for us to produce a finished product. Set out below are the production processes of our major products.

(i) Roasted Coffee

The following flow chart outlines the production process of our roasted coffee products:

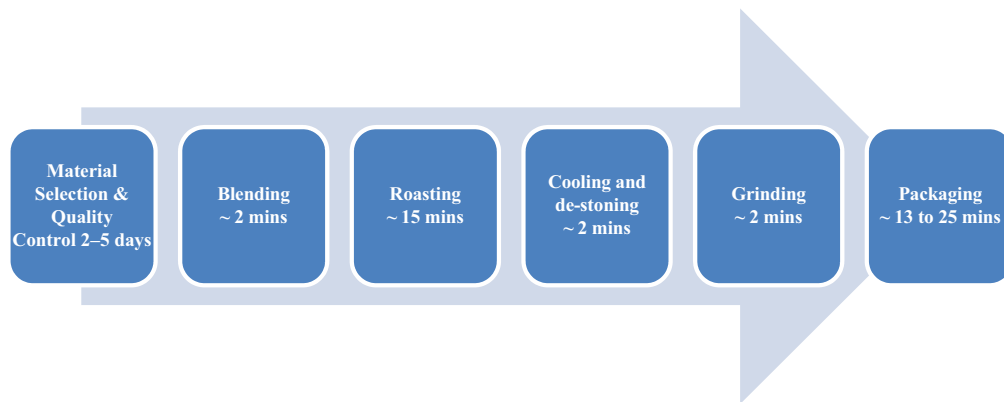

- (1) *Material selection and quality control:* Green coffee beans are subject to quality tests on their moisture, flavors, size and quality. Upon passing of the quality tests, they are vacuum-cleaned to remove any foreign material that may contaminate the beans.
- (2) *Blending:* Different types of cleaned green coffee beans are then blended in proportion according to different recipes to cater to various tastes and requirements of our customers. Our existing line allows blending of up to eight types of beans.
- (3) *Roasting:* After blending, the green beans undergo a large-scale roasting system. This roasting process removes all microbiological contamination to the beans. Roasting of coffee beans with different specifications in varying proportion and roasting time and temperature results in products with distinct aroma, richness and taste.
- (4) *Cooling and de-stoning:* Roasting will be followed by a rapid cooling and de-stoning process that removes foreign materials therefrom.
- (5) *Grinding:* After the roasted beans are cooled, they are either stored in bean form or processed further in a grinder to form ground coffee powder.

BUSINESS

- (6) *Packaging*: Our fully automated packing equipment allows us to pack our coffee products in different sizes ranging from a 85g pack to a five lbs pack and in different types of materials such as laminated aluminum foil fitted with de-gassing valve or filter paper to meet the varying demands of our clients.

We also conduct quality control measures throughout the entire production process such as x-ray scanning and barcode labelling to enhance traceability and to remove foreign materials. For further details, please refer to “— Quality Management — Beverage Solutions — Quality Control over Production Process” in this section.

(ii) Blended Tea

The following flow chart outlines the production process of our blended tea products:



- (1) *Material selection and quality control*: Processed tea leaves are subject to quality tests on their moisture, flavors, size and quality.
- (2) *Sieve cleaning*: Upon passing of the quality tests, processed tea leaves are cleaned by passing through a sieve whereby foreign material and contaminants are removed.
- (3) *Blending*: Processed tea leaves are then blended according to different formula that cater to various tastes and requirements of our customers.
- (4) *Packaging*: Our fully automated packing equipment allows us to pack our tea products in different sizes ranging from a 60g pack to a five lbs pack and in different types of materials such as laminated aluminum foil or filter paper to meet the varying demands of our customers. Our semi-automatic packing equipment allows us to pack our tea products in larger packing size of ten lbs.

BUSINESS

(iii) All-In-One Beverage Mix

The production of our All-In-One coffee, tea and yuan yeung products (collectively referred to as “**All-In-One Beverage Mix**”) is carried out in our production plant in Dongguan, the PRC.

The following flow chart outlines the production process of our All-In-One Beverage Mix:

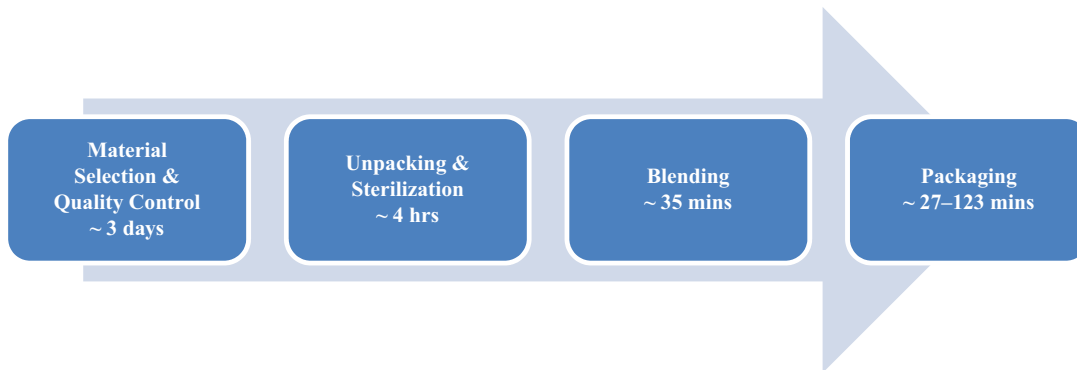

- (1) *Material selection and quality control:* Raw materials used in the production of our All-In-One Beverage Mix are instant coffee and tea powder, creamer and sugar. They are subject to thorough inspection before production, and our quality control division carries out checks on samples from our regular suppliers to ensure the quality of raw materials.
- (2) *Unpacking and sterilization:* Upon passing of the quality tests, the raw materials are unpacked in clean rooms and sterilized with Ultra-Violet (UV) light to remove any microbiological contamination.
- (3) *Blending:* Raw materials are then blended according to various blending recipes to produce the finished All-In-One Beverage Mix products.
- (4) *Packaging:* Finished products are then packed in sachets and boxes, ready for export to the Hong Kong market or for distribution in the PRC.

BUSINESS

CUSTOMERS

During the Track Record Period, our customers under direct sales primarily include fast food chains, Cha Chaan Teng, luxury hotels, cafe and restaurants, airlines and amusement parks in Hong Kong and the PRC. We have also engaged distributors for sales. For further details, please refer to “— Sales and Marketing — Sales by Channels — Distributors” in this section.

The table below sets out the breakdown of our revenue derived from direct sales and distributors for the periods indicated:

	Year ended December 31,					
	2015		2016		2017	
	(HK\$'000)	% of total	(HK\$'000)	% of total	(HK\$'000)	% of total
Beverage Solutions	634,723	75.7%	639,175	75.2%	711,349	74.5%
— Direct sales	574,380	68.5%	575,292	67.7%	631,821	66.2%
— Distributors	60,343	7.2%	63,883	7.5%	79,528	8.3%
Food Products	203,429	24.3%	210,545	24.8%	243,261	25.5%
— Direct sales	203,429	24.3%	210,545	24.8%	243,261	25.5%
Total	838,152	100%	849,720	100%	954,610	100%

The table below sets out the background information and revenue contribution of each of the Group’s five largest customers for the periods indicated:

For the year ended December 31, 2015

Rank	Customer name	Sales amount (HK\$'000)	(%) of total sales	Major products offered	Background of customer
1	Company S ⁽¹⁾	125,554	15.0%	Coffee, tea & grocery	Company S is the world’s leading quick-service restaurant and crosses over 100 countries with more than 36,000 outlets.
2	Oriole	25,644	3.1%	Frozen meats	Oriole is a private company. It provides different varieties of chilled products to suit the restaurants and hotels need. It is a connected person of our Company.
3	Company M	24,940	3.0%	Coffee, tea & grocery	Company M is a leading pan-Asian retailer. It operates supermarkets, hypermarkets, convenience stores, health and beauty stores and home furnishings stores under well-known brands.
4	Company L	22,196	2.6%	Coffee, tea & grocery	Company L was founded in 2004 and headquartered in Liuzhou, Guangxi. It’s a Hong Kong style beverage chain.
5	Company U	17,046	2.0%	Coffee, tea & grocery	Company U is one of the Asia’s largest publicly listed restaurant and catering groups. Company U is principally engaged in operating quick-service and specialty restaurant chains and has diversified both vertically and horizontally into the institutional catering and food processing business.

Note:

- ⁽¹⁾ Such sales include revenue derived from sales of coffee products at fixed prices as disclosed in the paragraph headed “Pricing” below in this section.

BUSINESS

For the year ended December 31, 2016

Rank	Customer name	Sales amount (HK\$'000)	(%) of total sales	Major products offered	Background of customer
1	Company S ⁽¹⁾	119,896	14.1%	Coffee, tea & grocery	Company S is the world's leading quick-service restaurant and crosses over 100 countries with more than 36,000 outlets.
2	Oriole	28,986	3.4%	Frozen meats	Oriole is a private company. It provides different varieties of chilled products to suit the restaurants and hotels need. It is a connected person of our Company.
3	Company M	28,508	3.4%	Coffee, tea & grocery	Company M is a leading pan-Asian retailer. It operates supermarkets, hypermarkets, convenience stores, health and beauty stores and home furnishings stores under well-known brands.
4	Company L	20,333	2.4%	Coffee, tea & grocery	Company L was founded in 2004 and headquartered in Liuzhou, Guangxi. It's a Hong Kong style beverage chain.
5	Company U	16,797	2.0%	Coffee, tea & grocery	Company U is one of the Asia's largest publicly listed restaurant and catering groups. Company U is principally engaged in operating quick-service and specialty restaurant chains and has diversified both vertically and horizontally into the institutional catering and food processing business.

For the year ended December 31, 2017

Rank	Customer name	Sales amount (HK\$'000)	(%) of total sales	Major products offered	Background of customer
1	Company S ⁽¹⁾	122,596	12.8%	Coffee, tea & grocery	Company S is the world's leading quick-service restaurant and crosses over 100 countries with more than 36,000 outlets.
2	Company M	37,996	4.0%	Coffee, tea & grocery	Company M is a leading pan-Asian retailer. It operates supermarkets, hypermarkets, convenience stores, health and beauty stores and home furnishings stores under well-known brands.
3	Oriole	37,455	3.9%	Frozen meats	Oriole is a private company. It provides different varieties of chilled products to suit the restaurants and hotels need. It is a connected person of our Company.
4	Company V	17,368	1.8%	Tea & grocery	Company V is a Japanese style "beef-bowl" fast food chain which established in Japan. The Company V Hong Kong branch was founded in 1991 and it entered into China market in 1992.
5	Company U	16,514	1.8%	Coffee, tea & grocery	Company U is one of the Asia's largest publicly listed restaurant and catering groups. Company U is principally engaged in operating quick-service and specialty restaurant chains and has diversified both vertically and horizontally into the institutional catering and food processing business.

Note:

- ⁽¹⁾ Such sales include revenue derived from sales of coffee products at fixed prices as disclosed in the paragraph headed "Pricing" below in this section.

Stable and diverse customer base

Over the years, we have built a stable and diversified group of customers that include multinational fast food chains and established Cha Chaan Teng that serve the needs of the mass market, and luxury hotels, airlines and amusement parks that demand for specialized products to cater to the tastes of a niche market. Our major customers include the franchised business of McDonald's in the PRC and Hong Kong, Yoshinoya, 7-Eleven, Café de Coral, Fairwood, Tsui Wah, Tai Hing and Spaghetti House. For the years ended December 31, 2015, 2016 and 2017, we had approximately 5,600, 5,800 and 6,100 customers, respectively. We have on average over ten years of experience supplying to our major customers.

BUSINESS

Beverage solutions business

We have exposure to a wide-range of food and service providers. Our diverse customer base gives us a distribution network that can reach approximately 60% of the food outlets in Hong Kong in 2016, which include approximately up to 77.6%, 70.3% and 78.7% market coverage of fast food stores, Cha Chaan Tengs and cafes respectively. Through the collaboration with fast food chains and other mass market caterers, the solutions we offer and the products we introduce receive extensive market exposure, which has not only supported our growth and helped us stay at the forefront of market trends, but also enhanced our position as a leading integrated B2B coffee and black tea solutions provider. At the same time, our customers that serve to the specific needs of a niche group allow us to enhance our industry knowledge and know-how for particular end user segments, and continue to build our capability as a comprehensive beverage solutions provider.

The extensive market exposure offered by our distribution network coupled with our dedication to customer service enables us to stay abreast of the latest consumer preferences across market segments. We believe the ability to stay current with the demands of diverse consumer groups differentiates us from most of our competitors, and has contributed to our success as an integrated coffee and tea solutions provider to a diverse group of customers.

The key terms with our major direct sales customers of beverage solutions are as follow:

- Term: Agreements with our major direct sales customers for beverage solutions generally have a term of one year and renewable upon expiry.
- Minimum purchase requirement: Our major direct sales customers for beverage solutions generally undertake to purchase a minimum amount of our products over the term of contract.
- Pricing: The price of product as agreed at the time of entry into contract is valid for the term of contract.
- Sales rebates: We generally provide sales rebates up to a certain percentage on a quarterly basis.
- Delivery: Products are generally delivered to our customers in Hong Kong within the next business day upon receipt of purchase order.
- Payment terms: We generally require payment on delivery or provide a credit period of 30 days. We generally require payment to be made by cash, cheque or by way of telegraphic transfer to our designated account.
- Return/Exchange of products: We generally allow for product returns due to quality issues only.

BUSINESS

- Ownership and maintenance of machines: We lease coffee machines to some of our customers of coffee products. During the term of the contract, we remain as the legal owner of the coffee machines and are eligible to claim against the customer for any serious damage or loss of the coffee machines. We provide maintenance services for the coffee machines during the term of the contract. We also provide free replacement of defective spare parts if the relevant defect is proved to be not a result of mishandling or negligent use of the coffee machine.

Food products business

Through the acquisition of the frozen meat related assets and business in 2013, we have built up a stable group of frozen meat customers, who are primarily catering to fast food restaurants and Cha Chaan Teng. Many of our frozen meat customers have long-established relationship with our subsidiary, Whole Sun. Through Whole Sun, they procure frozen meat and other specialty frozen meat products. We believe our commitment to sourcing quality products and ability to continuously procure and provide frozen meat products at competitive prices has contributed to our success in building a stable group of frozen meat customers.

The key terms with our direct sales customers of food products are as follow:

- Term: We do not enter into long term contracts with our direct sales customers for food products. Our customers for food products place purchase orders with us according to their business needs.
- Delivery: Products are generally delivered to our customers in Hong Kong within the next two business days.
- Payment terms: We generally require payment on delivery or provide a credit period of 30 days. We generally require payment to be made by cash or by way of telegraphic transfer to our designated account.
- Return/Exchange of products: We generally allow for product returns due to quality issues only.

For the years ended December 31, 2015, 2016 and 2017, sales to our five largest customers collectively accounted for approximately 21.8%, 22.4% and 23.9% of our total revenue for the food products segment during the same periods, respectively, and sales to our largest customer accounted for approximately 12.6%, 13.8% and 15.4% of our total revenue for the food products segment, respectively. As of the Latest Practicable Date, our relationships with our five largest customers during the Track Record Period ranged between seven to over ten years. Our five largest customers during the Track Record Period comprised of fast food chains, restaurants, a food and beverage distributor, a food processing company and a designated distribution center of an internationally renowned fast food chain. For further details regarding our sales arrangement with a designated distribution center, please refer to “— Sales and Marketing — Sales by Channels — Designated Distribution Center” in this section.

BUSINESS

One of our five largest customers during the Track Record Period, Oriole, was owned as to 52.4% and 47.6% by Mr. Chu Sun Chi (“**Mr. Chu**”) and his son, respectively. Subsequently, Mr. Chu transferred all of his interests in Oriole to his son. Mr. Chu and Ms. Fan Yin Fun (the spouse of Mr. Chu) are the minority shareholders of Whole Sun, holding an aggregate 40% of its entire issued share capital. For the years ended December 31, 2015, 2016 and 2017, our sales to Oriole amounted to approximately HK\$25.6 million, HK\$29.0 million and HK\$37.5 million, respectively, which accounted for approximately 3.1%, 3.4% and 3.9% of our total revenue for the same periods. Starting from January 1, 2018 due to the restructuring of the companies held by Mr. Chu’s son, Oriole International will gradually replace Oriole as the entity for purchase of frozen food from Whole Sun. For further details regarding our sales arrangement with Oriole/Oriole International going forward, please refer to the section headed “Continuing Connected Transactions — Non-fully Exempt Continuing Connected Transactions — Supply of frozen food to Oriole and Oriole International” in this prospectus.

As of the Latest Practicable Date, save for Oriole, our five largest customers were all Independent Third Parties. Except as disclosed herein, none of our Directors, or any of their respective close associates or any Shareholders (which to the knowledge of our Directors, owned more than 5% of the issued share capital of our Company as of the Latest Practicable Date) had any interest in any of the five largest customers during the Track Record Period. We generally extended credit terms of 30–120 days to our five largest customers during the Track Record Period, who primarily paid us via telegraphic transfer, which we believe to be in line with market practice.

During the Track Record Period and up to the Latest Practicable Date, we did not provide financing to any of our customers except for credit terms we granted to them. During the Track Record Period and up to the Latest Practicable Date, we did not experience any material product returns or product exchanges from our customers. For further details, please refer to “— Consumer Feedback, Product Returns and Warranties” in this section.

Pricing

We set the prices of our products based on a number of factors, including product costs (including raw material and packaging materials), overheads (including production, quality control and quality assurance costs), commodity prices, the relative pricing of competing products, production capacity, our bargaining power and the costs of providing after-sale services. We may offer volume discounts to customers on a case-by-case basis.

For one of our five largest customers, we generally enter into fixed price agreement nine months in advance to set the sales price of our coffee products for a period of three to twelve months with reference to the prevailing price and commodity futures price for coffee beans at the New York Board of Trade, to minimize the profit/loss effect of price fluctuation of coffee beans. For the years ended December 31, 2015, 2016 and 2017, the revenue we generated from this customer relating to sales of coffee products amounted to HK\$57.3 million, HK\$51.2 million and HK\$53.9 million, respectively.

BUSINESS

The unit price of our products fluctuated over the Track Record Period. The following table shows the average price ranges and sales volumes of our products by product category during the Track Record Period.

	Year ended December 31,					
	2015		2016		2017	
	ASP	Vol.	ASP	Vol.	ASP	Vol.
	(HK\$)	('000)	(HK\$)	('000)	(HK\$)	('000)
Beverage Solutions						
— Coffee (lbs)	30.4	6,404	29.4	6,450	29.6	6,700
— Tea (lbs)	27.2	6,930	27.2	7,017	28.6	8,000
— Milk (cartons)	275.5	291	269.5	343	262.4	370
Food Products						
— Frozen meat (kg)	31.7	6,374	28.9	6,987	32.6	6,957
— Frozen processed food (kg)	73.6	21	65.0	128	63.9	261

Raw Material Price Management

We believe a good raw material price management is important to our financial condition and profitability. Accordingly we regularly conduct market analysis over our primary raw materials and frequently communicate with our suppliers which allows us to gain valuable industry data that in turn allows us to both better forecast the future prices of our key raw materials and adjust our procurement plans accordingly. We believe our long established relationship with our major suppliers and our dedication in staying abreast of the latest raw material price movements has contributed to our financial stability and profitability during the Track Record Period, and we seek to continue to implement such measures going forward.

We primarily manage our raw material price of coffee beans through inventory management. For the Arabica coffee beans, we maintain three months of inventory at warehouse and three to six months on-way shipment. We generally keep stock of Robusta coffee beans equivalent to one and a half months of supply in our inventory and up to six months on-way shipment. Furthermore, we also manage our raw material price of coffee beans through negotiating and fixing differential contracts with coffee suppliers to further manage our procurement costs.

We engage in hedging activities for our coffee beans purchases only when necessary, and we limit the maximum hedging quantity of coffee beans based on our forecasted annual consumption, inventory on hand and in transit as well as the existing hedging contracts.

We did not have any profit or loss from hedging activities during the Track Record Period as we did not enter into any hedging contracts during the Track Record Period. Generally, we close the position of the hedging exercise within three days from the trade day by settling the futures contracts on hand in the volume equivalent to the volume of coffee

BUSINESS

beans purchased. We do not impose any stop-loss limit for our futures contract, as the contracts are only for hedging purpose and will eventually be matched against the physical purchase. The maximum accumulated net losses for one financial year shall not exceed US\$1 million.

Commodity Committee

We implement internal guideline on hedging and trading activities. Our Board of Directors and senior management oversee the hedging risks and set up risk limits and hedging procedures. We have comprehensive internal control and audit procedure in place as part of our hedging monitoring effort. Our Commodity Committee, consisting of Mr. Wong (our chief executive officer and executive Director), Group Chief Financial Officer, General Manager of Supply Chain, Procurement Manager, Production Manager and Research & Development Manager, manages the operation of our hedging and trading activities. The Commodity Committee decides the purchase amount of physical stock of coffee beans and related hedging decisions based on operational needs. Our finance department reviews our trading requirement on a monthly basis, performs risk control measures, prepares financial reports and carries out control over capital commitment and credit limits. Our internal audit department reviews and monitors our compliance with the internal guideline and reviews performance reports prepared by our finance department.

Sales Rebate Arrangements

The Group provides sales rebate to customers for their purchase of products including coffee, tea, milk, Lipton branded, Monin branded and other groceries. We set up rebate agreements with customers to identify the scope of products eligible for rebate, valid period for rebate, rebate rate and amount. There are four types redemption frequency, including monthly, quarterly, half-yearly and yearly. We use two types of rebate arrangements, namely fixed rate and progressive rate. Most of our customers with rebate agreements are subject to fixed rate arrangements. Under fixed rate arrangement, the rebate value is calculated by multiplying the sales amount by a fixed rebate rate. In Hong Kong, most of rebate rates fall within the range from 0.5% to 13%, while in the PRC, the range is from 0.5% to 15%. The less common progressive rate arrangement is adopted for rebating some fast-food restaurant customers. Under progressive rate arrangement, the rebate rate, which normally ranges from 0.2% to 5%, increases as the total sales amount within the contract period increases. For the years ended December 31, 2015, 2016 and 2017, the sales rebates we offered to our customers amounted to HK\$18.7 million, HK\$22.1 million and HK\$23.8 million, respectively.

BUSINESS

SALES AND MARKETING**Beverage Solutions Business***Sales and Marketing Team*

Our sales and marketing team is primarily responsible to plan and execute marketing strategies, including product management, product development, market research, corporate relations and marketing communications activities, such as directing advertising agencies in the production of media advertising planning, coordinating sales promotions and organizing exhibitions. As part of our integrated solutions, our sales and marketing team also regularly collaborates with our customers to initiate sales campaigns and advertisements for our customers' products, and to ensure our proposed solutions have the desired effect, our sales and marketing team would arrange for the provision and maintenance of coffee machines as needed. Moreover, we have collaborated with an institution which is an Independent Third Party to establish a coffee programme which provides professional and leisure courses to the public aiming to cultivate coffee culture and promote long-term development of the coffee industry. In addition, we have set-up one concept store in Dongguan, the PRC, which we apply as a tasting venue for customized products and we book revenue generated from this store under beverage solutions.

To support our business development, we utilize the QlikView Business Discovery Platform, or QlikView, to identify new business opportunities within our existing customer base. We apply the system to analyze sales data, including quantity, types of products and frequency of orders, from our customers. Through the system, we identify new cross-selling opportunities and modify product offering to existing customers based on individual and industry analyses on sales trends and business operation. The business analyses allow us to be more responsive and tailor our services according to the specific needs of our customers. We believe such value-added services have been instrumental in supporting our business growth.

BUSINESS

Sales by Regions***Hong Kong***

Since our establishment in Hong Kong in the early 1930s, we have gradually built an established sales and distribution network in Hong Kong throughout the years. In addition to our separate sales and marketing team for our frozen meat products, our sales and marketing team for our beverage solutions business in Hong Kong comprised more than 25 sales staff as of the Latest Practicable Date, and they are grouped under six divisions as follows:

- Hong Kong Island division;
- Kowloon division;
- New Territories division;
- Hotel and Institution division;
- FMCG division; and
- Import and export division.

The Hong Kong Island, Kowloon and New Territories divisions are responsible for catering sales to fast food chains and other individual food outlets, while sales staff from the Hotel and Institution division and the FMCG division specialize in handling sales and customer services in their respective sectors. The main functions of the six sales divisions are to conduct product training for our customers and maintain good business relationships with our customers and explore new business opportunities.

PRC, Macau and Other Overseas Markets

We entered into the PRC market since 1994 by introducing our coffee products and had a sales team of 32 personnel as of the Latest Practicable Date. In the PRC, we have been focusing our sales and distribution efforts in first and second-tier cities in eastern and southern China with strong market potential and rapid economic growth over the years, such as Beijing, Shanghai, Guangzhou, Zhuhai, Dongguan, Hangzhou and Shenzhen. As the PRC market is geographically more widespread than the Hong Kong market, we have set up a regional sales and distribution office in each of Beijing, Shanghai, Guangzhou, Shenzhen and Dongguan to cover major cities and special economic zones in the PRC. Macau is another important market to our business and we entered into the Macau market in 2012. In addition, we also sell a small portion of our products to Taiwan and other overseas countries including Canada, Australia, the United States, Malaysia and Philippines through distributors.

BUSINESS

Sales by Channels

We utilize both direct and indirect sales channels to distribute our products. The diagram below illustrates the structure of our sales channel strategy:

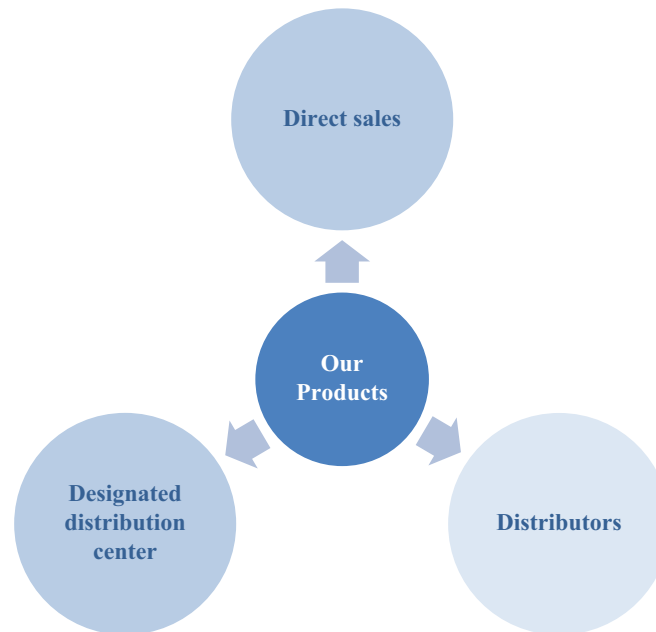
***Direct Sales***

In Hong Kong market, our sales and marketing team undertakes all direct sales to our customers. We also conduct a substantial portion of our sales in the PRC under direct sales. This ensures that our sales and marketing team works closely with our customers and is able to cater to their specific requirements. We regularly visit our customers, especially our commercial customers, to understand their needs and provide tactical and technical support for their sales and marketing activities, including helping them formulate menu management concepts according to the latest market trends.

A majority of our products are sold under direct sales to customers in the catering industry including major fast food chains, Cha Chaan Teng, cafes and restaurants as well as other food and beverage establishments, some of which have been our customers for over 10 years. We also supply our products to luxury hotels, amusement parks and airlines. For further details, please refer to “— Customers” in this section.

While our business in Macau and the PRC is relatively less mature than in Hong Kong, we have successfully secured contracts to supply coffee, tea, milk and other food and beverage related products with hotels, fast food chains, including more McDonald’s outlets in the PRC and domestic airlines.

We also derived our revenue from the direct sales of our FMCG products to retailer customers including supermarkets, as well as convenience stores such as 7-Eleven that are located throughout Hong Kong.

BUSINESS

The customers under direct sales for our food products business primarily include frozen meat processors which typically undertake further processing and packaging of our frozen meat products before re-selling to their customers. We generally do not enter into any sales agreement with our frozen meat customers and sell our frozen meat products to them by purchase orders.

Designated Distribution Center

We also sell our products to the franchised business of McDonald's in the PRC and Hong Kong via selling and delivering our products to an Independent Third Party distribution center designated by McDonald's globally (the "**Client Distribution Center**").

We engage in day-to-day operational discussions with the franchised business of McDonald's in the PRC and in Hong Kong directly, whereby we regularly participate in their menu management process, provide customized solutions, and form joint promotion campaigns.

At the same time, the franchised business of McDonald's in the PRC and Hong Kong places purchase orders with us through the Client Distribution Center. Per the arrangement, we do not deliver or collect payments from the franchised business of McDonald's in the PRC and Hong Kong. Instead, we deliver our products to the Client Distribution Center and recognize our sales upon delivery to and acceptance by the Client Distribution Center. We receive the payments directly from the Client Distribution Center. In the PRC, we allow for an "extended inventory model" in sales recognition whereby we only recognize our sales to the Client Distribution Center when our products are delivered by the Client Distribution Center to, and accepted by, the franchised business of McDonald's in the PRC.

In Hong Kong, we have entered into a business relationship agreement directly with the franchised business of McDonald's in Hong Kong pursuant to which a sale commitment would only arise when a written or electronic order for such products setting forth price, quantities and delivery, payment and other terms, is received. The franchised business of McDonald's in Hong Kong, through its approved party, the Client Distribution Center, issues a purchase order to us which set forth the product description, quantity and delivery date. As such, revenue is recognized when the goods are delivered to and acknowledged by the Client Distribution Center which signifies acceptance of our products by the Client Distribution Center. We do not have any further obligation after delivery of our products to the Client Distribution Center.

In the PRC, we have entered into a purchase agreement with the Client Distribution Center pursuant to which the ownership of the goods is only transferred to the Client Distribution Center when the goods are delivered by the Client Distribution Center to the franchised business of McDonald's in the PRC. We would bear the risk of loss if there is any damage of goods during the interim period between our products being held by the Client Distribution Center and the receipt of our products by the franchised business of

BUSINESS

McDonald's in the PRC. As such, revenue is only recognized when the goods are delivered by the Client Distribution Center and accepted by the franchised business of McDonald's in the PRC.

In terms of business relationship, we view the franchised business of McDonald's in the PRC and Hong Kong as our end customer.

Distributors

In addition to direct sales, we utilize distributors for sales of our beverage solutions products in the PRC, Macau and other overseas markets. We maintain stable cooperative relationship with our distributors. As of the Latest Practicable Date, we had on average more than four years of business relationship with our five largest distributors during the Track Record Period. We leverage our distributors' established access to their respective local markets to reach to our end customers and consistently expand the breadth and depth of our market presence in those jurisdictions.

Distribution agreements

We generally enter into standardized distribution agreements with our distributors that specify a variety of terms including designated geographic areas, sales targets and product return policies. The key terms of these agreements include:

- *Duration:* Majority of the distribution agreements have a term that ranges from one to two years and are renewable upon expiry. We generally start negotiating with our distributors on the renewal of distribution agreements three months prior to the expiration of the existing distribution agreements.
- *Designated Distribution Area and Market Segment:* Distributors are not allowed to sell or distribute our products outside of their designated distribution areas and market segments.
- *Exclusivity:* Majority of the distributors are granted the exclusive distributorship of certain types of products in a designated geographic area for specific market segment(s).
- *Sales Target and Minimum Purchase Requirement:* Majority of the distributors usually undertake to achieve a minimum annual sales target, which is determined and agreed between us and the distributor based on the distributor's capabilities. In the event that the distributor fails to meet 70% of its minimum annual sales target, we are entitled to terminate the distribution agreement.
- *Resale Price Management:* We suggest the prices at which our distributors resell our products to their customers. We also advise our distributors to not sell at a higher or lower price than our suggested price without consulting us.

BUSINESS

- *Inventory Level:* We generally require our distributors to maintain a minimum inventory level of goods that are available for supply for not less than 30 days. Majority of our distributors are required to provide monthly inventory information to us.
- *Return of Products:* We allow for product returns due to quality issues only. For reasons other than quality issues, our distributors can return products to us provided that our prior written consent is obtained. The products returned to us for reasons other than quality issues should have at least half of their shelf life remaining with the packaging undamaged.
- *Credit Terms:* We generally require payment before delivery or provide a credit period of 30 to 60 days. We generally require payment to be made by way of telegraphic transfer to our designated account.
- *Sales Incentives/Rebates:* We generally provide sales incentives/rebates of certain percentage based on the purchase amount of our distributors.
- *Confidentiality:* Distributors undertake not to disclose any of our trade secrets or other business information to any third party.
- *Termination:* The distribution agreements can be terminated with a 30-day advanced written notice given by either party in the event of, among other reasons, changing of title, reorganization, merger and acquisition. We are generally allowed to terminate the agreement immediately upon the distributor's failure to fulfill 70% of the sales target or the breach of the distribution agreement by the distributor.

Under the distribution agreements, we generally set the selling prices of the distribution products based on fluctuations of raw material prices. We generally sell our products to our distributors on a wholesale basis. We recognize revenue upon delivery to and acceptance by them. We retain no ownership over the products that we sell to them, and all significant risks and rewards associated with these products are transferred to them upon delivery to and acceptance by them. Our distributors then on-sell our products to retailers or other customers. They bear the risks as a result of default in their customer payment. As such, our relationship with our distributor is considered as a seller-buyer relationship.

Selection of our distributors

We adopt strict guidelines to select, assess and monitor our distributors. We typically conduct background search and examine and obtain copies of business licenses and tax registration certificates from our potential distributors in the PRC. We also consider a wide range of factors in selecting and evaluating the performance of our distributors including:

- locations, distribution network and customer base;
- relevant experience, reputation, creditworthiness and credibility;

BUSINESS

- capability in operation and management;
- warehousing facilities and delivery capabilities; and
- historical sales value and financial stance.

Our development and maintenance of a stable distribution network is supported by various factors, including (i) our well-recognized brand; (ii) working with a limited number of reputable and reliable distributors in each region, which helps to avoid cannibalization among them; and (iii) our comprehensive support and training provided to our distributors.

Management of our distributors

We generally enter into distribution agreements, with typical principal terms set out above, with our distributors. Our sales and marketing team constantly liaises with the representatives of our distributors in order to evaluate the predicted demand and plan for their upcoming orders. We also provide information including the expiry dates and storage requirements of our products to our distributors to ensure that our products are stored in a proper way by them and within the shelf-life.

In case there is any complaint of violations made against us, we typically investigate, and our sales and marketing team will properly address the complaint and form a decision.

To ensure our sales to our distributors reflect genuine market demand and mitigate the risk of cannibalization among our distributors, we adopt the following policies:

- we take into account the distributors' respective geographic territories as well as distribution channels when we select our distributors in order to ensure their sales networks do not materially overlap;
- our distributors are restricted under the distribution agreements to distribute our products in their respective designated distribution area and market segment(s) only;
- we set the suggested resale prices of our products and closely monitor the inventory level kept by our distributors to avoid excessive inventory accumulation; and
- we do not accept product returns unless the products are defective.

We were not aware of any material inventory accumulation in the distribution channels during the Track Record Period.

BUSINESS

The following table sets forth the changes in the number of our distributors as of the dates indicated:

Number of distributors	As of December 31,		
	2015	2016	2017
At the beginning of the period	149	162	170
Additions of new distributors	31	28	20
Termination of existing distributors	18	20	33
At the end of the period	162	170	157

The number of our distributors increased between 2015 and 2016 primarily as a result of our plan to expand our distribution channel and market coverage, particularly in the PRC. In addition, we engaged distributors that we believe have expertise in covering niche segments to help further develop our market coverage. As of December 31, 2017, the number of distributors we engaged decreased to 157 mainly because of (i) we adjusting our development policy and reducing our FMCG sales through distributors, (ii) our effort to focus on market development with established and/or larger distributors, and (iii) natural attrition.

During the Track Record Period, the annual sales target of our terminated distributors ranged between HK\$25,000 to HK\$1.3 million, and the aggregate revenue contributed by such terminated distributors were HK\$3.9 million, HK\$0.9 million and nil for the years ended December 31, 2015, 2016 and 2017, respectively.

To the best knowledge of our Directors, (i) the distribution model is adopted by some of the peers in the food and beverage industry; (ii) all of our distributors were Independent Third Parties, and none of them was wholly-owned or majority controlled by our current or ex-employees during the Track Record Period; and (iii) our distributors are primarily engaged in the business of distributing food and beverages in the relevant jurisdictions.

During the Track Record Period and up to the Latest Practicable Date, we did not provide financing to any of our distributors except for credit terms we granted to them under the relevant distribution agreements. During the Track Record Period and up to the Latest Practicable Date, we did not experience any material product returns or product exchanges from our distributors. For further details, please refer to “— Consumer Feedback, Product Returns and Warranties” in this section.

Food Products Business

For our acquired frozen meat business, we generally maintained its original sales and marketing team of seven members to take charge of the sales and marketing of our frozen meat products due to their long relationship with the suppliers and customers. We have installed a business software, Gideon, to track our frozen meat business sales. Since 2016, the sales data of our frozen meat business has been integrated with our ERP system to enhance operational management, sales performance evaluation and to identify cross-selling opportunity.

BUSINESS

We conduct sales and marketing of frozen processed food through our sales and marketing team of our beverage solutions business. Similar to our beverage solutions sales, our sales personnel helps our frozen processed food customers customize products which best meet their needs. We aim to provide frozen processed food to our customers and integrate such products into our customer's central kitchen. For further details of our beverage solutions sales, please refer to “— Sales and Marketing — Beverage Solutions Business — Sales and Marketing Team” above in this section.

DELIVERY AND LOGISTICS

We utilize our in-house delivery capability as well as third party logistics service providers to ensure efficient delivery of our products. During the Track Record Period and up to the Latest Practicable Date, we did not experience any material delay in delivery of our products and we believe the use of our in-house logistics team as well as third party logistics service providers will ensure sufficient transportation capacity for our future expansion. Although our third party logistics service providers can provide us with professional service, there are risks relating to our outsourced logistics services. For further details regarding risks regarding our outsourced logistics services, please refer to the section headed “Risk Factors — Risks Relating to Our Business — We rely on third party logistics service providers to deliver some of our products, and our sales and reputation may be materially and adversely affected by delays in delivery or poor handling by such third party logistics service providers.” in this prospectus.

Beverage Solutions

To ensure that our products reach our customers in optimal quality, we have established delivery services of within 24 hours for our beverage solutions products. Leveraging off our well-established pre-delivery system, our dedicated team of delivery staff, a fleet of 11 delivery trucks and one van and our third party logistics service providers, we have been able to provide a reliable delivery services to customers throughout Hong Kong within 24 hours from receiving an order.

To facilitate accurate and timely delivery of our beverage solutions products to our customers located in the PRC, we have established a warehouse covering over 6,930 sq. meters with an integrated professional logistics system at our Dongguan plant to coordinate deliveries with the third party logistics service providers. During the Track Record Period, there was no material disruption of the logistics service in the PRC.

Food Products

We generally engage reputable logistics companies to provide storage and distribution services for our frozen meat and frozen processed food products sold in Hong Kong due to the requirement of cold chain logistics. The logistics companies are generally responsible for delivery of our frozen meat and frozen processed food products from ports to our third-party warehouses as well as management of frozen meat and frozen processed food storage in the warehouses they rent to us.

BUSINESS

Most of our customers in Hong Kong pick up our frozen meat and frozen processed food products directly at our third-party warehouses. In cases when delivery service is required by our frozen meat and frozen processed food customers, our third party logistics companies can assist us in providing logistics support to serve our customers in various regions in Hong Kong at our request. For customers who choose to pick up our frozen meat and frozen processed food products from us, they are generally able to receive the products on the next working day of their order. For local customers that require delivery service, the lead time is usually one working day.

PROCUREMENT OF RAW MATERIALS AND SUPPLIERS**Beverage Solutions**

We have a global supply network, primarily consisting of a group of globally renowned suppliers, with whom we have on average over ten years of procurement experience. Through our major suppliers, we have access to quality raw materials from different continents across various climate zones that could be applied to our production, which primarily include coffee beans, tea leaves and milk for our beverage solutions business. We benefit from their comprehensive portfolio of quality-assured raw materials from different continents at various climate zones, which allows us to quickly formulate the tastes for products according to our customer's demand.

In addition to raw and packaging materials we purchase for our coffee and tea production, we source a wide variety of trading products that enable us to provide our commercial customers with one-stop purchase experience. Our strong sourcing ability is proved by our ability to secure exclusive distribution agreements with our strategic suppliers. For example, we are the distributor of Lipton yellow label tea in Hong Kong and we are the sole authorized agent of the French luxurious syrup brand "Monin" in Hong Kong and Macau, with which we collaborate with our customers to create innovative beverage recipes.

Food Products

We do not undertake any processing and repackaging of our frozen meat and frozen processed food products imported from overseas suppliers. We import frozen meat and frozen processed food products only from countries and suppliers approved by the Food and Environmental Hygiene Department of Hong Kong. During the Track Record Period, we imported pork primarily from Japan, Brazil, the United States and Vietnam, and beef primarily from the United States, Japan, Brazil, Australia and New Zealand, poultry primarily from the United States and Thailand. Substantially all of our frozen meat and frozen processed food suppliers are manufacturers of frozen meat and frozen processed food instead of upstream distributors.

BUSINESS

We generally place orders with our suppliers based on demand and do not enter into any long-term purchase agreements with our frozen meat and frozen processed food suppliers. We maintain stable and long-term working relationship with a majority of our suppliers. We have regular visits at our suppliers' factories and offices to conduct quality control review on their manufacture processes and safety standards. We are responsible for customs clearance in Hong Kong for our imported frozen meat and frozen processed food. Pursuant to the Import and Export Ordinance (Chapter 60 of the Laws of Hong Kong), each consignment of the frozen meat, chilled meat, frozen poultry and chilled poultry is to be covered by one import license for which we are responsible to obtain. Hence, each consignment of our imported frozen meat must be accompanied with valid health certificates issued by the recognized issuing entity of the exporting country.

For the years ended December 31, 2015, 2016, and 2017, our cost of raw materials (including packaging materials) was approximately HK\$562.2 million, HK\$543.9 million and HK\$632.2 million, respectively, accounting for approximately 95.0%, 94.5% and 95.1% of our total cost of sales for the same periods, respectively.

Selection of Raw Material Suppliers

We carefully select our suppliers by evaluating their overall track record, financial strengths, reliability, stability of supply, quality control measures, reasonableness of price as well as logistics arrangements. Having met our selection criteria, the supplier will become our qualified supplier. As we believe that stringent food quality and safety standards are our core values, we closely communicate with and monitor our suppliers and require all raw materials provided by them to meet our stringent internal and the relevant national and/or international quality standards. We typically require our suppliers to provide certificates to us for their supply of raw materials. For further details, please refer to “— Quality Management — Beverage Solutions — Quality Control over Procurement” in this section.

For the years ended December 31, 2015, 2016 and 2017, purchases from our five largest suppliers collectively accounted for approximately 44.3%, 43.2% and 44.3% of our total cost of sales during the same periods, respectively, and purchases from our largest supplier accounted for approximately 24.5%, 22.5% and 22.8% of our total cost of sales for the same periods, respectively. We have had relationships with our five largest suppliers during the Track Record Period for six to over ten years as of the Latest Practicable Date. Our five largest suppliers during the Track Record Period comprised trading houses that help us source for raw materials such as coffee beans and tea leaves from producers in Brazil, Colombia and Sri Lanka and raw meat slaughter and packaging exporter in New Zealand. Our five largest suppliers during the Track Record Period generally grant us credit terms of up to 60 days from invoice date with respect to supply of raw materials. Payments are generally settled by telegraphic transfer.

BUSINESS

For the years ended December 31, 2015, 2016 and 2017, our largest supplier was the Former Shareholder. Such purchases were conducted with reference to the market price and our Directors confirmed that such purchases were at arm's length and on normal commercial terms. For further details, please refer to the section headed "History, Development and Corporate Structure" in this prospectus. Except as disclosed herein, none of our Directors, or any of their respective close associates or any Shareholders (which to the knowledge of our Directors, owned more than 5% of the issued share capital of our Company as of the Latest Practicable Date) had any interest in any of the five largest suppliers during the Track Record Period. We did not experience any material disruption, disputes, shortage or delay in the supply of raw materials and components with our suppliers during the Track Record Period. We are generally able to pass on fluctuations of increases in raw material prices to our customers.

The table below sets out the background information and purchases from each of the five largest suppliers for the periods indicated:

For the year ended December 31, 2015

Rank	Supplier name	Purchase (HK\$'000)	(%) of total cost of sales	Major sourcing	Background of supplier
1	Company N (the Former Shareholder)	145,036	24.5%	Tea and milk	Company N is a Japan-based company providing various services and products.
2	Company P	50,318	8.5%	Liptons	Company P has been in business since the 1880s providing more than 400 brands.
3	Company O	24,996	4.2%	Frozen beef & lamb	Company O is a New Zealand multinational meat co-operative. The company is New Zealand's leading livestock processing and marketing company.
4	Company R	22,467	3.8%	Coffee	Company R focuses primarily on coffee, cotton and cocoa products. It purchases raw materials from producers of origin, providing primary processing, logistics and risk management services and selling to the branded product manufacturers with operations in various countries.
5	Company Q	19,727	3.3%	Coffee	Company Q is a company founded in 1851. It is a merchant and processor of agricultural goods specializing in food, agriculture, metals, transportation, and risk management services.

For the year ended December 31, 2016

Rank	Supplier name	Purchase (HK\$'000)	(%) of total cost of sales	Major sourcing	Background of supplier
1	Company N (the Former Shareholder)	129,619	22.5%	Tea and milk	Company N is a Japan-based company providing various services and products.
2	Company P	49,850	8.7%	Liptons	Company P has been in business since the 1880s providing more than 400 brands.
3	Company Q	26,428	4.6%	Coffee	Company Q is a company founded in 1851. It is a merchant and processor of agricultural goods specializing in food, agriculture, metals, transportation, and risk management services.
4	Company O	24,946	4.3%	Frozen beef & lamb	Company O is a New Zealand multinational meat co-operative. The company is New Zealand's leading livestock processing and marketing company.
5	Monin	17,668	3.1%	Syrup	Monin was founded in France. It offers various products including premium syrup, liqueurs, gourmet sauces, fruit smoothies and cocktail mixes and frappe powders.

BUSINESS

For the year ended December 31, 2017

Rank	Supplier name	Purchase cost of sales (HK\$'000)	(%) of total cost of sales	Major sourcing	Background of supplier
1	Company N (the Former Shareholder)	151,570	22.8%	Tea and milk	Company N is a Japan-based company providing various services and products.
2	Company P	53,372	8.0%	Liptons	Company P has been in business since the 1880s providing more than 400 brands.
3	Company Q	31,441	4.7%	Coffee	Company Q is a company founded in 1851. It is a merchant and processor of agricultural goods specializing in food, agriculture, metals, transportation, and risk management services.
4	Company R	30,156	4.5%	Coffee	Company R focuses primarily on coffee, cotton and cocoa products. It purchases raw materials from producers of origin, providing primary processing, logistics and risk management services and selling to the branded product manufacturers with operations in various countries.
5	Company O	28,330	4.3%	Frozen beef & lamb	Company O is a New Zealand multinational meat co-operative. The company is New Zealand's leading livestock processing and marketing company.

QUALITY MANAGEMENT**Beverage Solutions**

As a food and beverage provider, our key focus is to ensure that our products are safe and of high quality. We implement and maintain stringent quality control in all aspects to ensure the safety and quality of our products throughout our procurement, production, storage and distribution. We maintain internationally recognized standards of quality control and hygiene to ensure that only quality products are produced from our production facilities. Moreover, we have installed automated and digitized systems to ensure product traceability by pack and minimize offline manual operation.

As of December 31, 2017, we had a team of six and 16 quality control personnel based in Hong Kong and the PRC, respectively. Most of our quality assurance personnel are graduates of nutrition, food science or a related discipline with relevant working experience in food and beverage manufacturing/quality control.

International Accreditations and Certifications***HACCP***

We have adopted the HACCP processes at our production facilities. We were awarded the HACCP certificates by SGS Hong Kong Limited in Hong Kong since December 2006 and by China Quality Certification Centre in the PRC since November 2011 for our production of coffee and tea-related products. HACCP is an internationally recognized system for reducing the risk of safety hazards in food, which includes a reduction in biological, chemical or physical hazards. In compliance with HACCP, we are required to exercise and maintain hazard analysis, critical control points with regular records of relevant regulatory limits, and conduct corrective measures when necessary to ensure that our production process is compliant with the HACCP process.

BUSINESS

ISO

In addition, we have been accredited with ISO 9001:2008 in Hong Kong and the PRC, since 2006 and 2011, respectively, as well as ISO 22000:2005 in Hong Kong since 2008 and in the PRC since 2011 for our coffee and tea production. Through our ISO 9001 certification, we have demonstrated that our operation consistently meets the customer and applicable statutory and regulatory requirements. While our ISO 22000 approval certifies that our raw material procurement, production, finished goods and distribution meets relevant international standard with regard to eliminating biological, chemical and physical hazards.

These certifications denote our commitment to pursuing a sound and comprehensive quality and safety management, thereby ensuring our products are safe and of high standard.

Quality Control over Procurement

Our stringent quality control procedure starts with monitoring of the quality of our raw materials. We have defined specifications for our raw materials including origin, size and moisture requirements. We apply strict supplier approval procedure and only source from approved suppliers with industry recognition, like ISO 22000 and HACCP certificates. We may also conduct audit of potential suppliers prior to procurement from them.

Pre-shipment Sample Checks

Our major raw materials are coffee beans and processed tea leaves imported from overseas markets. Before accepting a batch of coffee beans or processed tea leaves, we receive samples of each shipment from our suppliers and conduct pre-shipment sample checks, which generally include sensory tests of color, aroma, taste and appearance compared with the last accepted lot of goods if applicable, physical measurements such as tea grain size distribution, chemical measurements of total dissolved solids and pH values. We only accept the batch of raw materials if the relevant pre-shipment sample meets our requirements.

Incoming Inspection

After the coffee beans and processed tea leaves arrive at local ports, we perform incoming inspections that generally include certificate verifications, quantity checks, net weight checks, packaging checks, sensory tests, physical measurements, chemical measurements, cupping tests and retention of inbound samples of received raw materials.

Quality Control over Production Process

Production is carried out in clean and good manufacturing practice rooms, and all production staff are required to wear protective clothing to ensure that products are free from contaminants.

BUSINESS

Quality control over the production process of roasted and grounded coffee products comprises the following measures:

- *Blending Inspection:* For the blending process, we check cross reference lot number of raw materials and blending composition to make sure of the exact specification of raw materials and proportions for blending.
- *Roasting Monitoring:* We monitor roasting time and temperature and conduct roasting color index checks for work-in-progress. The quality control staff conducts random checks on the roasted coffee beans on a batch by batch basis to assess if the roasting level is up to standard. We also check the water filtered through our filter system during roasting and test-filtered water quality every year in laboratory. Furthermore, we monitor air pressure index in the de-stoning process.
- *Grinding Inspection:* We check grinder settings and carry out calibration of grinder by using sieve devices to ensure conformity of grind size twice per year.
- *Packaging Inspection:* We use different packaging techniques such as vacuum packing to make sure that our products are packaged properly. We inspect packing sealing and check the production/expiry date and product code on the package of our products. Unique batch codes are assigned for each production batch to increase lot traceability. We also conduct net weight check and conduct metal detection with an x-ray inspection system.

Quality control over production process of our tea products and All-In-One Beverage Mix products generally comprises the same blending inspection and the packaging inspection measures as aforementioned that apply to our roasted and grounded coffee products.

Regarding our quality control measures for beverage solutions products manufactured under OEM arrangement, please refer to “— OEM Contractors” in this section.

Quality Control over Finished Products

We record specifications including color index, total dissolved solids value, pH value and net weight of our finished roasted and grounded coffee products. For our finished tea products, we record specifications including moisture, net weight and ash content. For our finished All-In-One Beverage Mix products, we record specifications including moisture and net weight. We also conduct cupping tests to assure the proper aroma, acidity, sweetness, richness and aftertaste of our coffee and tea products. We retain samples for every production batch of finished products. Unique batch codes are assigned for each production batch to increase lot traceability, and we perform product recall drill on a regular basis.

BUSINESS

Quality Control over Warehousing, Logistics and Distribution

We store our raw materials and finished products at our warehouses located in Hong Kong and the PRC. Management of our warehouses is supported by our ERP system. We assign specific lot numbers for each batch of our incoming raw materials and finished products to ensure traceability. Consumption of raw materials and finished products are on a first-in, first-out basis. We closely monitor our storage environment, including temperature and humidity, in our warehouses to ensure that our raw materials and finished products maintain proper conditions during storage. Moreover, we perform pest control regularly to ensure our warehouses are pest-free.

We also adopt quality control measures to avoid contamination during delivery. For instance, our products are delivered in a temperature and humidity controlled environment and we conduct regular hygiene checks on our delivery trucks.

Food Products

Food and Environmental Hygiene Department of Hong Kong is responsible for implementing territory-wide policies of food safety control and enforcing the food legislation. To this end, part of its duties is to exercise the power provided under Section 62(1) of the Public Health and Municipal Services Ordinance to take food samples at points of entry to the territory for various kinds of tests, including microbiological examinations and chemical analyses. In addition to tests conducted by local government authority on imported food products, we, as food importer in Hong Kong, are responsible for ensuring that food items we procure comply with the local legislation through close liaison with exporting countries. In particular, selected food items such as meat, poultry and marine products have specific legal requirements or administrative arrangements for import due to their perishable or high-risk nature. For further details, please refer to the section headed “Regulatory Overview — Overview of Hong Kong Laws and Regulations — Import and Export Ordinance (Chapter 60 of the Laws of Hong Kong)” in this prospectus. For risks relating to our raw materials (including the March 2017 Brazil meat incident), please refer to the section headed “Risk Factors — Risks Relating to Our Business — Any health or food safety problems or negative publicity and media reports related to our raw materials, our products, our operations or the general beverage and frozen meat and frozen processed food industry could materially and adversely affect our business, reputation and our ability to sell our products.” in this prospectus.

Quality Control over Procurement

We import frozen meat and frozen processed food products only from countries and suppliers approved by Food and Environmental Hygiene Department of Hong Kong. To help ensure hygienic standards of imported food, we require our frozen meat and frozen processed food suppliers to provide health certificates issued by the relevant issuing entities of countries of origin to accompany their products certifying that the food products concerned are fit for human consumption. For our products imported from Japan, we only import food products from such prefectures of Japan approved by the Hong Kong government with certificates issued by their Ministry of Agriculture, Forestry and Fisheries pursuant to the regulations.

BUSINESS

Quality Control over Warehousing, Logistics and Distribution

We engage professional third party logistics companies to manage appropriate storage of frozen meat and frozen processed food at our warehouses as well as during delivery. Our contracted third party frozen food logistics companies in Hong Kong are responsible for ensuring safety and suitable storage conditions, which can help guarantee quality of our frozen meat and frozen processed food products. Our frozen meat and frozen processed food warehouses are equipped with surveillance cameras that record the whole discharge and storage process. Moreover, we have the right to conduct onsite visit and audit at our frozen meat and frozen processed food warehouses at any time. We periodically check on our frozen meat and frozen processed food products stored at our warehouses especially when new cargos arrive.

Quality Control over OEM Contractors

Regarding our quality control measures for frozen processed food products manufactured under OEM arrangement, please refer to “— OEM Contractors” in this section.

OEM CONTRACTORS

We produce a certain portion of our products at our own production facilities, while we engage OEM contractors which are Independent Third Parties based in countries including Lithuania, Czech Republic and Thailand to expand and diversify our product offerings. These products primarily include milk products for our beverage solutions business and some frozen processed food for our food products business. The products are produced in factories operated by our OEM contractors, and the final products are sold under our brands. Our OEM contractors are generally responsible for sourcing raw materials and conducting quality control for products they manufactured for us under OEM arrangements. We also conduct quality control of products manufactured by our OEM contractors by shipment. As of December 31, 2015, 2016 and 2017, we had engaged eight, 10, and 11 OEM contractors, respectively, and most of them had established business relationships with us for more than two years.

We select our OEM contractors based on stringent criteria, including historical performance, production facilities, management competency, quality control, technical know-how, and financial status. In addition, all of our OEM contractors are subject to an annual evaluation, which includes an assessment on their product quality, price and product delivery time. Typically, we enter into master OEM agreements with our OEM contractors with a term ranging from one to three years. Such agreements, together with the relevant orders placed with OEM contractors, generally set out terms including product specifications, requirements for production, minimum order quantity and payment arrangements. The payments we make to our OEM contractors reflect the relevant costs of production, mainly including raw materials, labor and processing, as well as a fee in relation to the OEM services provided. The terms of the OEM arrangements vary depending on the relevant products, but typically include the following.

- Term: The valid term is generally one to three years, subject to renewal.

BUSINESS

- **Exclusivity:** The OEM contractor and its associates are not allowed to directly or indirectly distribute the same product to food service market as well as convenience stores in the relevant territories without written mutual consent in advance.
- **Pricing:** Unit prices are typically specified, subject to specified adjustment as approved mutually.
- **Purchase quantity:** Purchase quantity is generally specified in purchase orders. Typically, the agreement specifies the minimum purchase quantity per purchase order.
- **Payment terms:** Typically, we settle the payment within 45 days after receipt of invoice.
- **Delivery:** The OEM contractor generally delivers the products on “cost and freight” terms, meaning the OEM contractor will cover all costs, except insurance, to deliver the products to the port of destination, or on “cost, insurance and freight” terms, meaning the OEM contractor will cover all costs, including insurance, to deliver the products to the port of destination.
- **Lead time:** The lead time is generally 60 calendar days upon receipt of purchase order.
- **Product specification:** We generally specify the product details including product name, packing specification, physical analysis, chemical analysis, microbiological analysis, ingredient composition, process flow, nutrition information and product shelf-life.
- **Regulatory compliance:** The OEM contractor is responsible for complying with the food legislations in Hong Kong and these applicable in its jurisdiction.
- **Product complaint:** Upon receipt of product complaints from us, the OEM contractor has full responsibilities to investigate thoroughly and offer full explanations with preventive and corrective measures reported to us by writing within 10 working days. The OEM contractor is responsible for actual and verifiable defects from its manufacturing process.
- **Intellectual property:** The OEM contractor should not use our brand or trademark for any commercial or non-commercial purposes.
- **Termination:** Typically may be terminated by us immediately upon the breach of agreement by the OEM contractor or by either party by giving three months’ written notice.

BUSINESS

Typically, OEM contractors request settlement of payment within 45 days after receipt of invoice. For the years ended December 31, 2015, 2016 and 2017, purchases from our OEM contractors were approximately HK\$61.7 million, HK\$67.7 million and HK\$50.4 million, representing approximately 10.4%, 11.8% and 7.6% of our total cost of sales, respectively.

For the years ended December 31, 2015, 2016 and 2017, purchases from our five largest OEM contractors accounted for approximately 99.5%, 98.2% and 95.3%, respectively, of our total purchase from OEM contractors, and purchases from our largest OEM contractor accounted for approximately 82.4%, 71.6% and 52.9%, respectively, of our total purchase from OEM contractors for the corresponding periods. Our Directors confirmed that none of our Directors, or their respective close associates, or any Shareholder (who to the knowledge of our Directors) holding more than 5% of the issued Shares had any interests in any of these five largest OEM contractors throughout the Track Record Period.

As of the Latest Practicable Date, we had not encountered any material disruption to our business as a result of failure to obtain OEM-supplied products, and we had not experienced and do not envisage that we will experience any material difficulties in obtaining the required OEM products. Our continued use of OEM contractors is subject to certain risks. For further details, please refer to the section headed “Risk Factors — Risks Relating to Our Business — We outsource the production of some of our products to OEM contractors. Any disruption in the supply of our products could have a material and adverse effect on our business, financial condition and results of operations.” in this prospectus. As of the Latest Practicable Date, we were not aware of any violation by our OEM contractors of material laws and regulations applicable to them.

BUSINESS INTELLIGENCE AND INFORMATION TECHNOLOGY

We utilize information technology systems to support our operations, procurement, inventory control, sales management, finance and cost control, production planning and overall management function. A suite of integrated applications including SAP, QlikView, and the Gideon System forms our ERP system.

Supply Chain Management

Our ERP system is fully integrated with production planning and supply chain management features. We have adopted an internationally renowned business operation system to manage the supply chain of the products from suppliers to customers. The system facilitates the management of inventory, adheres to the first-in-first-out method and effective overall warehouse management by tracking various activities including purchase orders and inventory level.

Timely access to the daily inventory and sales data allows our management to efficiently monitor sales performance and make decisions in planning, sourcing, manufacturing, and delivering products. As we are able to monitor the inventory movement and sales data in an effective and systematic manner, we can make

BUSINESS

appropriate operational adjustments in response to market conditions and customer needs and forecast future demands more accurately. Such measures, in turn, have contributed to our cost management and enhanced our profitability.

For our food products business, we employ the Gideon System for inventory management. The Gideon System tracks and monitors the inventory, storage and sales of our frozen meat products, as well as organizing the billing into the accounting system.

Business Analysis Management

Our ERP system is also capable of combining business data from different sources and producing a near real-time report to facilitate our review of operational results and decision making.

Upon obtaining operating data from SAP and the Gideon System, we use QlikView, for business analysis of our Hong Kong operations on procurement decision and operational efficiency. QlikView performs near real-time customized sales analysis on individual products. We then utilize such analysis to adjust purchasing decisions and product offering. We have also identified cross-selling opportunities in Hong Kong through the analysis provided by QlikView, which in turn, allows us to apply targeted marketing strategy. We believe such features have been instrumental in supporting our growth over the Track Record Period.

Financial Reporting Management

Our ERP system also centralizes our accounting and reporting procedures and integrates transaction bookings from several modules including procurement and sales for the financial reporting. With integrated financial information gathered from different stages of our business, our management team can better understand the overall performance of the business and make necessary operational adjustments more efficiently.

INVENTORY CONTROL**Raw Materials and Work-In-Progress**

Our two production facilities are equipped with warehouses. Our warehouses in Hong Kong for our beverage solutions segment have a total area of over 76,488 sq. feet, for storage of raw materials, finished goods and packaging materials. We have established a warehouse covering over 6,930 sq. meters with an integrated professional logistics system at our production facilities in Dongguan, the PRC. To cope with the market demand and production schedule, we manage our inventory levels and maintain higher inventory levels carefully to ensure not more than three months' inventory for items of our products under beverage solutions segment with a lead time of two months.

In addition, as of the Latest Practicable Date, we rented five warehouses in Hong Kong from four third party logistics service providers specifically for storage of our frozen meat and frozen processed food products with controlled temperature and humidity. Such third party logistics service providers are responsible for the safety and supervision of our

BUSINESS

warehouses to ensure sound storage conditions such as temperature for our frozen meat and frozen processed food products during storage in our warehouses. We monitor inventory levels of our frozen meat and frozen processed food products carefully and generally maintain an inventory of frozen meat and frozen processed food products for around two months' sale.

Finished Products

Our finished products under beverage solutions segment are stored and distributed mainly by our sales and marketing team and distributors. We generally aim to maintain inventory levels that are sufficient for fulfilling the forecasted demand which are on average no more than three months' inventory levels. Our sales and marketing team will meet with our production team to provide market information to production and procurement team on production schedules and material purchase plans.

We periodically review our inventory levels for slow moving inventories, obsolescence or declines in market value. We have implemented detailed warehousing operating procedures such as first-in-first-out inventory management practice and periodic stock taking. We also organize promotion sales for inventories approaching expiry dates.

As of December 31, 2015, 2016 and 2017, our closing balance of inventories amounted to approximately HK\$163.7 million, HK\$147.2 million and HK\$195.4 million, respectively, which represented approximately 42.7%, 33.5% and 45.0% of our total current assets, respectively. Our average inventory turnover days were 117, 99 and 94 days for the years ended December 31, 2015, 2016 and 2017, respectively. For further details, please refer to the section headed "Financial Information — Description of Certain Components of Statements of Financial Position — Inventories" in this prospectus.

PRODUCT DEVELOPMENT

As one of the leading integrated B2B coffee and black tea solutions providers in Hong Kong, it is vital for us to keep abreast of the latest market trends, developments and consumer tastes, and evaluate and improve our existing product recipes and product portfolio to meet the evolving demands of our customers. We have a product development team consisting of four and eight professionals in Hong Kong and in the PRC, respectively, who come from various departments. All of our product development personnel have qualifications in food science or chemical engineering and/or possess five or more years of experience in the food and beverage industry.

Our product development team is led by our senior product development manager, who has over 30 years of experience in food research and development and is an expert member of Food Canning Committee of China National Food Industry Association (中國食品工業協會罐藏委員會專家委員). The team consists of experienced food engineers, as well as tea and coffee tasters and trainers with the relevant professional experience. 10 of the 12 personnel on the team are degree or diploma holders. Our product development team also includes personnel that hold multiple professional qualifications, including ISO22000 Internal Inspection Qualification (ISO22000內審員資格證), Senior Public Dietician (高級公

BUSINESS

共營養師) and International Food Intermediate Inspector (國際食品中級檢驗工). Our chief tea & coffee master has over 24 years of experience in tea and coffee product development with the Group.

With a market-oriented focus, our product development team is capable of analyzing market trends and the evolving consumer tastes, assessing the marketability and growth of new and existing products locally and internationally.

Customizing products

Our product development team works closely with our sales and marketing team to bring concepts into commercially viable products. We constantly work with our commercial customers in their menu and recipe management and developing customized blends of coffee and tea to suit the patrons of our customers' food and beverage outlets. Blending of raw materials with different specifications in varying proportion and roasting time results in products with distinct aroma, richness and taste. In order to develop desired flavors, our product development team conducts research on features of raw materials, such as the region and the altitude level of the origins of the coffee beans.

In addition, we work towards recommending and designing appropriate types of product packaging for our customers. For instance, depending on the customers' requirements, the laminated aluminum foil packaging can be fitted with a de-gassing valve to enhance freshness by allowing a one-way outflow of biogas released from the coffee. Packaging in suitable material and size is recommended to individual customers after taking into consideration the type of food and beverage establishment they operate, the equipment they use and the desired shelf life of the products.

Identifying and launching new products

With the help of our in-house trained coffee and tea masters, we are able to taste and analyze products of our competitors effectively so that we can develop new products based on those valuable references. Once a new product is identified, our product development team conducts feasibility studies of the production process to make sure we have necessary production capacity, technology and equipment to conduct mass production of such new product. We can usually launch a new blend of coffee and tea product from one to three months after identifying it.

Regarding our products of OEM or trading nature, we leverage on our market intelligence to identify popular products and our sourcing ability, to constantly identify and source new products to optimize our product mix and provide our customers with a one-stop purchase convenience.

BUSINESS

During the Track Record Period, we conducted food and beverage studies on our target markets and the relevant expenses incurred were recorded as part of our product development expenses. As at the Latest Practicable Date, our ongoing research and development projects are as follow:

Project/ Product	Description	Current status	Expected completion or launch date	Expected amount of funds needed
Tea machine	To design and construct a fully automated tea machine in collaboration with Rex-Royal to complement our milk tea products for sale to customers	In the process of creating prototype	Second half of 2019	HK\$10.0 million ⁽¹⁾
Beverage solutions library	To create a library or database of all of our beverage solutions in order to better archive our product formulations	In the process of completing user testing phase	First half of 2018	HK\$0.5 million

Note:

- (1) A substantial portion of the expense will be applied to create the mold for the tea machine.

For the years ended December 31, 2015, 2016 and 2017, we recorded product development expenses (other than amortization cost) of HK\$0.1 million, HK\$0.2 million and HK\$0.1 million, respectively, representing mainly the staff travelling costs of our product development personnel and food and beverage study fee incurred, and such costs did not include the salary of our product development personnel as staff costs relating to the conduct of such activities were included in such staff's salary. As such staff belong to various departments and as our management tracks staff costs based on the different functions for internal analysis and planning purposes and does not track the time spent by the product development personnel on specific projects, the corresponding costs do not qualify for capitalization in accordance with the relevant requirements under HKFRSs and were expensed off during the Track Record Period. Going forward, we do not plan to change the accounting treatment of these costs and will continue to expense future costs of same or similar nature as they do not meet the capitalization criteria set by the relevant accounting standard, while capitalize research and development costs that meet the relevant criteria. During the Track Record Period, none of our product development expenses were capitalized and thus we did not incur any amortization cost in this regard. For the years ended December 31, 2015, 2016 and 2017, no product development expense has been capitalized as intangible assets.

CONSUMER FEEDBACK, PRODUCT RETURNS AND WARRANTIES

Consumer Feedback

We value consumer feedback as they form the foundation for our continuous improvement. We maintain consumer service hotlines for consumer inquiries, feedback and complaints. Our products are imprinted with a label containing information such as

BUSINESS

production date and time and batch number which facilitate us in addressing these issues by tracing relevant information recorded in our management system. Based on the information collected by our customer services division, the relevant departments are notified about any reported product defects and carry out remedial measures as necessary. Furthermore, our material review board reviews customer complaint logs every month and follows up on unsolved problems if any. In case of any product defects, we consider whether our suppliers are liable and negotiate with them as necessary.

Product Returns and Warranties

Other than defective products, our customers are generally not allowed to return or exchange our products after they have accepted delivery, except that we may permit our customers providing catering services in Hong Kong to return to us certain products including coffee and tea at least three months before the product expiry date under limited circumstances. We have standard protocol on the return or exchange of our products with different treatments according to factors including the type of the products, the number of days between the invoice date and the date the return is requested by the customer, and the packaging conditions of the products. In particular, we designate a special return policy for caterers closing their business from which we will accept returns at a discount. Approvals are required from different levels of management to approve of the returns according to the value of the returned products involved. The sales revenue of the returned products was directly deducted from our total revenue of the relevant period. We are responsible for the costs of returning or exchanging the returned products.

Crisis Management Committee

We believe that food safety is of paramount importance. We have designated a Crisis Management Committee (“CMC”), which comprises of our senior management from various departments, and implemented a product recall policy to recall substandard products that are already circulating in the market. Should we suspect the quality of our products is compromised, our food safety team which consists of our human resources and administration manager, supply chain manager, purchasing manager, quality assurance manager, logistics manager, research and development representative and sales manager will first evaluate the situation and report to our CMC. The CMC will decide whether to recall and make detailed recall plans including the methods, quantities and timelines of the recall. We have divided our product recalls into three categories depending on the severity and impact of the product issues. Products will then be recalled from different sales channels according to the category assigned. The food safety team will prepare notices setting forth details of the recalled products. The recalled products will be isolated and inspected to determine the cause of the problem and the appropriate disposal method. The food safety team will also prepare a comprehensive report upon completion of the recall to reflect on the process and the result of the recall and advise any preventive measures.

During the Track Record Period and up to the Latest Practicable Date, there have been no material product recalls or product returns from our customers and we had not experienced any material complaint or product liability or other legal claims from our customers due to problems with the quality of our products.

BUSINESS

INTERNAL CONTROL AND RISK MANAGEMENT**Internal Control**

It is the responsibility of our Board to ensure that we maintain sound and effective internal controls to safeguard our Shareholders' investment and our assets at all times. We have adopted, or expect to adopt before the Listing, a series of internal control policies, procedures and programs designed to provide reasonable assurance for achieving objectives, including effective and efficient operations, reliable financial reporting and compliance with applicable laws and regulations. In particular, such measures include:

1. the engagement of an independent internal control consultant and adoption of the improvement measures recommended by such consultant;
2. the establishment of the Audit Committee responsible for overseeing the financial records, internal control procedures and risk management systems of our Company;
3. the appointment of BOSC International Company Limited as our compliance adviser upon the Listing to advise us on compliance with the Listing Rules;
4. the engagement of external legal advisers to advise us on compliance with the Listing Rules and to ensure we will not be in breach of any relevant regulatory requirements or applicable laws, where necessary; and
5. providing trainings to our relevant employees on the regulatory requirements and applicable laws relating to PRC properties to prevent re-occurrence of the historical non-compliance incidents with details set out in “— Legal proceedings and compliance” below in this section.

We have taken steps to ensure the effective implementation of our internal control system by establishing a team to organize and review our internal control system and by providing guidance to our Directors, senior management and employees with respect to our internal control policies and the duties and responsibilities of directors and management of listed companies under the Listing Rules and other applicable laws and regulation.

Risk Management

With the growth and expansion of our operations, potential risks associated with our business increase as well. In order to identify, assess and control the risks that may create impediments to the growth of our business, we have designed and implemented risk management policies to address various potential risks identified in relation to our operations, including operational risks, credit risks, market risks, financial risks and legal risks. Our risk management policies set forth procedures to identify, analyze, categorize, mitigate and monitor various risks as well as the reporting hierarchy of risks identified in our operations. Each of our business departments and functions is responsible for identifying and evaluating the risks relating to its area of operations and implementing our risk management and internal control systems. Our Audit Committee is responsible for

BUSINESS

overseeing our management in the implementation of our overall risk management and internal control systems and assessing the efficiency of our risk management and internal control systems. Key personnel of our internal control and risk management include a risk management and operation manager and an internal audit manager who individually has more than ten years' experience in the professional field.

INTELLECTUAL PROPERTY RIGHTS

As of the Latest Practicable Date, we held 47 registered trademarks in Hong Kong and 91 in the PRC which were material to our business. We had 7 pending trademark applications and 3 trademark renewal applications in the PRC as of the Latest Practicable Date. In addition, we were the owner of 29 domain names as of the Latest Practicable Date. Details of our intellectual property rights are set forth under the sections headed “Appendix IV — Statutory and General Information — B. Further Information about the Business of Our Group — 2. Intellectual Property Rights” and “Appendix VI — Intellectual Property Rights” in this prospectus.

We consider our intellectual property to be valuable assets and we undertake a proactive approach to manage our intellectual property portfolio. Our employment contracts generally contain confidentiality and non-competition provisions to protect our intellectual property rights, confidential information and know-how, pursuant to which our employees agree not to divulge any confidential information obtained during the course of their employment with us and not to compete with us for a period of six months after termination of their employment. We engaged a third-party agent to watch and report use of the mark “TWG” globally. We take action when we are aware of an infringement of our trademarks. For instance, during the Track Record Period, we commenced proceedings in Hong Kong against TWG Tea Co Pte Ltd and the Wellbeing Group (HK) Company Limited for infringing our registered trademarks which include “TWG”. For details, please refer to the paragraph headed “— Legal Proceedings and Compliance” in this section.

All the products sold by us are genuine products and should not be confused with counterfeits. Having considered the current legislation including the Trade Marks Ordinance, the Copyright Ordinance and common law, our Directors are satisfied that there is no material risk of any action being brought against us related to any alleged

BUSINESS

infringement of intellectual property rights relating to our products which, if successful, would have a material and adverse effect on our business and operations.

We also rely on trade secrets to protect our know-how in formulating our products, especially where we believe patent protection may not be appropriate or obtainable. Our employment contracts with employees and the employees' manual contain confidentiality provisions with respect to the handling of our confidential information including know-how and trade secrets.

COMPETITION**Beverage Solutions**

Our main competitors in the beverage business in Hong Kong range from small to medium sized individual coffee roasters and tea distributors to international coffee and tea companies. In Hong Kong, there are over ten individual coffee roasters with whom we compete directly for the supply of coffee, tea and other grocery products to Cha Chaan Tengs. There were approximately 16,560 food and beverage serving establishments in Hong Kong in 2016. Our diverse customer base gives us a multi-channel distribution network that can reach approximately 60% of the food outlets in Hong Kong in 2016, which include approximately up to 77.6%, 70.3% and 78.7% market coverage of fast food stores, Cha Chaan Tengs and cafes, respectively.

We also compete with the top five Hong Kong and international coffee and tea companies in the catering of coffee and tea to hotels and restaurant chains in Hong Kong according to Frost & Sullivan Report. We currently supply to 34 of the 240 hotels in Hong Kong and nine of the 11 major fast food chains that operate more than ten outlets each in Hong Kong. The top five players in the B2B coffee and black tea products market in Hong Kong had a 70.8% market share in 2016 and we ranked the first in terms of revenue in 2016, accounting for 24.5% of the market.

In the PRC, the B2B coffee and tea products market is highly fragmented. In 2016, the top five companies in terms of revenue accounted for only 14.8% of total B2B coffee and black tea products market in the PRC. We face competition from internationally recognized brands as well as local coffee producers in the PRC. We currently cater to more than 800 hotels, fast food chains and food establishments in the major cities of Beijing, Shanghai, Wuhan, Guangzhou and Shenzhen in the PRC. We also cater to seven domestic airlines in the PRC out of approximately 24 domestic airlines.

Food Products

The frozen meat products market in Hong Kong is highly fragmented, with over 100 companies focusing on providing frozen meat wholesale services. Due to the resell nature of our frozen meat and frozen processed food trading business, our frozen meat and frozen processed food suppliers and customers all have the possibility to be our competitors in this industry. The frozen meat market in Hong Kong has developed positively in the past several years, expanding from HK\$4,758.2 million in 2012 to HK\$6,237.6 million in 2016 at a CAGR of 7.0%.

BUSINESS

In the PRC, the frozen meat market is highly fragmented with a large proportion of individual producers and processors and small-scale workshops. The market leaders are mainly large state-owned-enterprises and joint ventures with industrialized production and better food safety management. As there is an emerging trend for the major players to engage in vertical integration by extending their services from poultry and livestock production to frozen meat and frozen food processing, it is expected that the frozen market industry in the PRC will become increasingly consolidated and concentrated. The frozen meat market in the PRC has risen significantly from RMB115.7 billion in 2012 to RMB192.7 billion in 2016 with a CAGR of 13.6%. The Frost & Sullivan Report forecasts that by 2021, the total market size of frozen meat is expected to reach RMB290.3 billion in 2021, growing at a CAGR of 7.8% from 2017.

EMPLOYEES

Our operations and financial affairs are centrally managed out of our headquarters in Hong Kong. All of our management team is based in Hong Kong. As of December 31, 2017, we had 506 employees including 234 based in Hong Kong and 272 based in the PRC. The following table shows a breakdown of our employees by function as of December 31, 2017:

Functions	Number of Employees	% of Employees
Supply Chain	138	27.3%
Sales and Marketing	106	20.9%
Production	117	23.1%
Corporate Management	62	12.3%
Human Resource	34	6.7%
Quality Assurance	22	4.3%
Procurement	15	3.0%
Research and Development	12	2.4%
Total	<u>506</u>	<u>100.0%</u>

Our employees typically enter into standard employment contracts with us. Remuneration packages for our employees may comprise one or more of the following elements: base salary, productivity-related incentives and performance-related bonus. We set performance attributes for our employees based on their position and department and periodically review their performance. The results of such reviews are used in their salary determinations, bonus awards and promotion appraisals. We offer various benefit plans to our employees, including top-up leave entitlement, pension, medical, life insurance and maternity benefits. Our employees in the PRC are unionized according to local labor laws. As of the Latest Practicable Date, we did not experience any strikes or any labor disputes with our employees which have had or are likely to have a material effect on our business.

BUSINESS

We place high value on recruiting, training and retaining our employees. We maintain high recruitment standards and provide competitive compensation packages. We also provide in house and external trainings relating to management and professional skills and knowledge, and food safety trainings. We also sponsor the external training of our employees.

We provide on-the-job training to all employees and require supervisors to provide daily coaching and counselling to employees on adapting to the work environment and improving work methods. We also schedule both in-house and external trainings at the beginning of each year with courses tailored to employees with different functions. For example, we provide our production staff members with Good Manufacturing Practices training, personal hygiene and safety training, and tea packing procedure training. We also adopt evaluation programs through which our employees can receive feedback. We foster strong employee relations by offering various staff benefits and personal development support.

AWARDS AND HONORS

The following table sets forth our major awards and recognitions:

Year	Award	Awarding issuing authorities
2012	The Hong Kong's 100 Most Influential Brands of the Year (2012香港100最具影響力品牌)	World Brand Laboratory
2013	Best Practice Award	Franchised business of McDonald's in the PRC and Hong Kong
2014	Best Business Partner	7-Eleven
2015	Biggest Importer of Ceylon Tea in China Bronze Winner (中國區進口斯里蘭卡茶最大進口商銅獎)	Sri Lanka Tea Board (斯里蘭卡茶葉局)
2016	The Golden Supplier 2015–2016 (2015–2016年度金牌供應商)	Hotel Investors Association China Real Estate Chamber of Commerce
2016	2015年度麥當勞中國傑出品質領導力A級供應商	麥當勞中國食品質量管理部門
2016–2018	Social Capital Builder (社會資本動力獎)	Labor and Welfare Bureau (勞工及福利局)

BUSINESS

Year	Award	Awarding issuing authorities
2014 and 2017	The Comprehensive Catering Service Supplier of China (中國最佳綜合餐飲服務供應商)	The Organizing Committee of Annual Meeting of the China Hotel Industry (中國飯店業年會組織委員會)
2008–2017	Caring Company (商界展關懷)	The Hong Kong Council of Social Service (香港社會服務聯會)
2016	Beijing Cuisine Association Best Cooperation Company (北京烹飪協會最佳合作單位)	Beijing Cuisine Association (北京烹飪協會)
2016	Quality Food Traceability Scheme Gold Enterprise Winner (優質食品源頭追蹤計劃金獎)	GS1 Hong Kong (香港貨品編碼協會)
2016	Family-Friendly Employer (家庭友善僱主)	Home Affairs Bureau (民政事務局)
2017	Food Ever Award Silver (銀級惜食傳承獎)	Hong Kong Women Professionals & Entrepreneurs Association (香港女工商及專業人員聯會)
2017	Quality Food Traceability Scheme Diamond Enterprise Winner (優質食品源頭追蹤計劃鑽石獎)	GS1 Hong Kong (香港貨品編碼協會)
2017	Waste Never Award Silver (銀級惜食成就獎)	Hong Kong Women Professionals & Entrepreneurs Association (香港女工商及專業人員聯會)
2017	知慳惜電勁減百份比大獎 (機構組)亞軍	Friends of the Earth 地球之友

BUSINESS

HEALTH, WORK SAFETY, SOCIAL AND ENVIRONMENTAL MATTERS**Health and Safety Matters**

We are subject to various laws, regulations and standards in Hong Kong and the PRC which stipulate the requirements to maintain safe production conditions and to protect the occupational health of employees. Pursuant to these requirements, an entity that is not sufficiently facilitated or equipped to ensure safe production shall not engage in production and business operations. For details, please refer to the section headed “Regulatory Overview” in this prospectus. The design, manufacture, installation, use, inspection and maintenance of production facilities and equipment are required to conform to applicable national or industrial standards.

We have implemented safety measures at our production facilities to ensure compliance with applicable regulatory requirements and to minimize the risk of injury to employees. We have implemented health and work safety guidelines for all our employees which set out our health and work safety policies and promote health and safety on work sites. In addition, we commissioned professional test evaluation service companies to perform regular examination on occupational hazard factors on workplaces. We commissioned safety training companies to conduct safety evaluation on the workshops. Furthermore, we have established Health and Safety Committee in Hong Kong to provide training and education for our employees, investigate causes of accidents and issue audit report. We believe these measures help reduce the number and seriousness of work injuries of our employees and are adequate and effective to prevent serious work injuries. We believe we are in compliance with the applicable health and safety laws and regulations in all material respects, and have not had any incidents or complaints which had materially and adversely affected our financial condition or business operations during the Track Record Period.

During the Track Record Period, we had immaterial work-related injury claims and the total compensation we paid for these work-related injury claims was approximately HK\$747,513 in aggregate, which were or would be entirely covered by our employees compensation insurance. Save as disclosed in the paragraph headed “— Legal Proceedings and Compliance” in this section, as of the Latest Practicable Date, our Group had no material ongoing work-related injury claims.

BUSINESS

Environmental Matters

We are subject to certain laws and regulations in relation to environmental protection in Hong Kong and the PRC. Under applicable PRC laws and regulations, any workshop construction or renovation must be subject to an environmental impact assessment and approved by the relevant environmental protection authorities before the commencement of the construction work. Following the completion of the construction or renovation project, normally, we should obtain and pass an onsite inspection by the relevant environmental protection authorities before we officially commence use of the relevant site. See the section headed “Regulatory Overview” in this prospectus for further information about these laws and regulations.

Our production process produces a small amount of waste water and solid wastes. In order to comply with the relevant environmental laws and regulations, we have adopted anti-pollution measures for the effective maintenance of environmental protection standards. We were in compliance in all material respects with applicable environmental laws and regulations during the Track Record Period. In addition, we commissioned professional environmental protection companies to treat and, where possible, recycle waste materials. We were accredited ISO 14001:2004 for both our operations in Hong Kong and the PRC that demonstrated our efforts to environment protection in relation to our production. ISO14001 is a family of standards related to environmental management that exists to help organizations (a) minimize how their operations (processes, etc.) negatively affect the environment (i.e., cause adverse changes to air, water, or land); (b) comply with applicable laws, regulations and other environmentally oriented requirements; and (c) continually improve in the above. During the Track Record Period, we were involved in two non-compliant environmental acts in relation to emitting black smoke that caused nuisance. We paid a total amount of fines of HK\$15,000 as required by Environmental Protection Department of Hong Kong according to Air Pollution Control Ordinance (《空氣污染管制條例》). As of the Latest Practicable Date, we have rectified such incidents and to reduce the risk of similar incidents, we have updated our production equipment maintenance procedure manual on April 29, 2017. To ensure compliance with applicable laws and regulations, we have appointed a manager to supervise and monitor compliance with statutory regulations and our internal standards in respect of environmental matters and we keep a record of relevant accidents and non-compliance. We are not currently involved in any material environmental claims, lawsuits, penalties or administrative sanctions.

During the Track Record Period, our compliance costs relating to environmental laws and regulations were insignificant. Our Directors expect that our ongoing cost for compliance with applicable environmental laws and regulations should not increase significantly.

BUSINESS

INSURANCE

We maintain insurance coverage including medical, employee compensation, life, and travel insurance for our employees, as well as business interruption, commercial general liability, vehicle, contaminated products, crime, machinery breakdown, money, property, inland transit, marine cargo and directors' and officers' liability. For our frozen meat and frozen processed food business, we are generally responsible for purchasing marine insurance to cover the risk of loss or damage during carriage for the import of our frozen meat and frozen processed food. We have commercial general liability insurance and contaminated products comprehensive insurance coverage regarding our frozen meat and frozen processed food storage.

During the Track Record Period and up to the Latest Practicable Date, we had not made, neither had we been the subject of, any insurance claims which are of a material nature to the Group.

During the Track Record Period, we contributed to social security insurance for our employees in compliance with applicable PRC laws, rules and regulations in all material respects.

Our Directors believe that the insurance coverage for our operation was adequate and was in line with industry practice as of the Latest Practicable Date. However, the risks related to our business and operations may not be fully covered by insurance. For further details, please refer to the section headed "Risk Factors — Risks Relating to Our Business — Our insurance coverage may not be adequate to cover all the risks." in this prospectus.

PROPERTY**Owned Properties in Hong Kong and the PRC**

As of the Latest Practicable Date, we owned 14 properties in Hong Kong with an aggregate gross floor area of approximately 34,865 sq. feet. for our production facilities, warehouses and supporting office, as well as seven parking spaces.

As of the Latest Practicable Date, we held the land use right to one parcel of land in Dongguan, the PRC with a site area of 31,999.05 sq. meters and four building ownership certificates for properties on that parcel of land in Dongguan, the PRC. In addition, we hold three building ownership certificates for properties in Guangzhou, the PRC. The aggregate gross floor area for our production facilities, offices and employees' dormitory for which we hold building ownership certificates is 21,800.54 sq. meters. We occupy another parcel of land in Dongguan, the PRC without any certificate between June 30, 2010 and July 13, 2014 but subsequently obtained collective-owned land use rights certificate on July 14, 2014. We are applying to change the nature of the land use rights of this parcel of land to state-owned land. During this process, we are required to surrender the collective-owned land use rights certificate pending completion of the land grant process. For further details, please refer to the paragraph headed "Legal Proceedings and Compliance — Non-compliance Matters" in this section.

BUSINESS

Leased Properties in Hong Kong and the PRC

As of the Latest Practicable Date, we leased and occupied 21 properties in Hong Kong with an aggregate gross floor area of 68,516 sq. feet. for our warehouses, offices and apartment, as well as four car parking spaces and six vehicle licensing areas.

As of the Latest Practicable Date, we leased and occupied five properties in Beijing, Shanghai, Shenzhen and Zhuhai, the PRC with an aggregate gross floor area of 677.3 sq. meters for our offices.

Pursuant to Rule 5.01B(2) of the Listing Rules, if the carrying amount (as defined in Rule 5.01(1) of the Listing Rules) of a property interest (as defined in Rule 5.01(3) of the Listing Rules) is or is above 15% of its total assets (as defined in Rule 5.01(4) of the Listing Rules), the prospectus shall include the full text of valuation report for such property interest. Pursuant to Chapter 5 of the Listing Rules, this prospectus is not required to include valuations of our properties.

LICENSING, APPROVALS AND APPLICATIONS

In order to operate our beverage solutions and food products businesses in Hong Kong, we are required to obtain and maintain licenses such as food business license, including a Food Factory License (食物製造廠牌照), which is generally granted for a term of one year and subject to annual renewal. For our food products business in Hong Kong, any person who carries on a food importation/distribution business is required to register with Director of Food and Environmental Hygiene Department as a food importer/food distributor in Hong Kong.

For beverage solutions and food products business in the PRC, any person who carries on production, circulation or operation of food business is required to obtain relevant certificates issued by the local food and drug regulatory authorities at and above the county level.

BUSINESS

Our Directors, as advised by our PRC Legal Advisers and Hong Kong Special Counsel, confirm that we have obtained all necessary licenses, permits and approvals for business operations from the relevant authorities for all of our subsidiaries. The following table sets forth key licences, registrations and certificates relating to our business and operations (apart from those pertaining to general business requirements), issuing authorities, date of latest grant and expiry date:

Jurisdiction	Type of licence/registration/ certificate	Subsidiary	Issuing Authority	Date of Latest Grant	Expiry Date
PRC	Certificate for Food Production (食品生產許可證)	DGTW	Dongguan Food and Drug Administration Bureau* (東莞市食品藥品監督 管理局)	September 30, 2016	February 25, 2021
PRC	Certificate for Food Circulation (食品流通許可證)	CDCL	Market and Quality Supervision Commission of Shenzhen Municipality (深圳市市場和質量監督管 理委員會)	March 18, 2016	March 17, 2019
PRC	Certificate for Food Operation (食品經營許可證)	SHTW	Shanghai Pudong Market Supervision Authority* (上 海市浦東新區市場監督管理 局)	May 3, 2017	May 2, 2022
Hong Kong	Food Factory Licence <i>(Note 1)</i>	COFE	Food and Environmental Hygiene Department	October 1, 2017	September 30, 2018
Hong Kong	Food Factory Licence <i>(Note 1)</i>	COFE	Food and Environmental Hygiene Department	December 10, 2017	December 9, 2018
Hong Kong	Food Factory Licence <i>(Note 1 and 2)</i>	COFE	Food and Environmental Hygiene Department	October 1, 2017	September 30, 2018
Hong Kong	Food Importer/Food Distributor Registration	Whole Sun	Food and Environmental Hygiene Department	January 28, 2016	January 27, 2019
Hong Kong	Factory Registration	COFE	Trade and Industry Department	August 1, 2017	July 31, 2018

Note 1: Each premises in Hong Kong in which our Group operates as a food factory requires a separate Food Factory Licence.

Note 2: Pursuant to sections 4 and 5 and Schedule 1 of the Food Safety Ordinance (Chapter 612 of the Laws of Hong Kong), a company holding a Food Factory Licence is exempted from the Food Importer/Food Distributor Registration. As COFE has obtained a Food Factory Licence which entitles it to carry on a food importation and food distribution business, it is exempted from the requirement of obtaining a Food Importer/Food Distributor Registration.

We will apply to renew the relevant licenses when they are due to expire, and our Directors, as advised by our PRC Legal Advisers and Hong Kong Special Counsel, are not aware of and do not foresee any legal impediment to renew such licenses when they expire. For further details regarding the laws and regulations that we are subject to, please refer to the section headed “Regulatory Overview” in this prospectus.

* For identification purposes only

BUSINESS

LEGAL PROCEEDINGS AND COMPLIANCE

We are subject to legal proceedings and claims that arise in the ordinary course of business.

Save as disclosed below, during the Track Record Period and up to the Latest Practicable Date, no member of our Group was engaged in any litigation, claim or arbitration of material importance and no material litigation, claim or arbitration of material importance is known to our Directors to be pending or threatened against any member of our Group.

Legal Proceedings***Employees' compensation claims and personal injury claims***

During the Track Record Period and up to the Latest Practicable Date, there were four employees' compensation claims and two personal injury claims against our Group which arose from four workplace accidents relating to two employees that took place on September 1, 2014, June 8, 2015, October 5, 2016 and November 24, 2016, respectively.

The workplace accidents which occurred on September 1, 2014 and June 8, 2015 relate to the same employee. In both accidents, the employee sprained his back while performing lifting tasks in a lorry. This injured employee commenced both employees' compensation claims and personal injury claims against our Group for each of the above two workplace accidents. Pursuant to a District Court order on June 15, 2017, these two employees' compensation claims were consolidated as one legal action. By an order dated September 28, 2017, these two employees' compensation claims were fully settled, which were fully covered by insurance. Pursuant to a High Court order on October 27, 2017, the two personal injury claims were consolidated as one legal action (the "**Consolidated Personal Injury Claims**"). By a consent order dated March 13, 2018, the Consolidated Personal Injury Claims were fully settled, which will be fully covered by insurance.

The workplace accidents which occurred on October 5, 2016 and November 24, 2016 relate to another employee. For the accident which occurred on October 5, 2016, the employee slipped and fell onto the ground due to slippery floor while delivering goods to our customers, as a result of which he sustained injuries to his lower back and right elbow. For the accident which occurred on November 24, 2016, the employee sustained injuries to his lower back while performing lifting tasks. As of the Latest Practicable Date, this injured employee commenced employees' compensation claims for each of the above two workplace accidents and no personal injury claims have been commenced against our Group.

BUSINESS

Save as disclosed above, all of these claims were still ongoing as of the Latest Practicable Date. As of the Latest Practicable Date, the two outstanding employees' compensation claims filed by the injured employee with the court in respect of the workplace accidents that took place on October 5, 2016 and November 24, 2016 did not show the compensation amount claimed and therefore the maximum potential exposure of these two employee compensation claims could yet be assessed. All the above ongoing employees' compensation claims are expected to be fully covered by the insurance policy maintained by us and thus no provisions for any liability have been made.

We have implemented health and work safety guidelines and enhanced internal control measures in response to these injuries. For details, please refer to the paragraphs headed "Health, Work Safety, Social and Environmental Matters" in this section.

Litigation in relation to outstanding trade receivables

On February 22, 2017, CDEL brought a claim, by issuing a writ of summons, against one of our customers located in the PRC (the "**Defendant**") for a sum of approximately HK\$5.4 million, including the amount of defaulting payment for the goods (i.e. prune) sold and delivered by CDEL to the Defendant and the expenses we incurred while discontinuing our prune business in the PRC as a result of the default of the Defendant. The defaulting payment of HK\$2.1 million was recognised as impairment loss for the two years ended December 31, 2016. CDEL filed and served a statement of claim on November 16, 2017. As of the Latest Practicable Date, CDEL has obtained final judgment from the High Court of Hong Kong, pursuant to which the Defendant was ordered to pay CDEL a sum of approximately HK\$5.4 million and legal costs of the proceedings.

Litigation in relation to trademark infringement

On December 23, 2011, TWHK, TWIC, COFE and TW Café Limited brought a claim against TWG Tea Co Pte Ltd and The Wellbeing Group (HK) Company Limited (the "**Defendants**") for infringement of our registered trademarks and passing off of our trademarks in Hong Kong.

On July 24, 2013, the Court of First Instance passed judgment in favour of our Group. The Defendants appealed to the judgment of the Court of First Instance. The appeals to the Court of Appeal and the Court of Final Appeal were dismissed on December 3, 2014 and January 29, 2016, respectively. As a result of these legal actions, the Defendants were not allowed to use the brand and logo bearing "TWG Tea" in Hong Kong.

We received compensation in an aggregate amount of HK\$26.0 million from the Defendants, which was recognized as other income and gains, net in the amounts of approximately HK\$10.0 million and HK\$16.0 million for the years ended December 31, 2015 and 2016, respectively. For further details, please refer to the section headed "Financial Information — Description of Certain Components of Consolidated Statements of Profit or Loss and Other Comprehensive Income — Other income and gains, net" in this prospectus.

BUSINESS

Non-compliance Matters

We are subject to a wide variety of laws, rules and regulations in the ordinary course of our business. For further details, please refer to the section headed “Regulatory Overview” in this prospectus. Except as disclosed below, to the best knowledge of our Directors, we complied with the law and regulations of Hong Kong and the PRC applicable to us in all material aspects during the Track Record Period and up to the Latest Practicable Date.

Non-compliance incidents	Reasons	Legal consequences and potential maximum penalties	Remedial actions and current status
<p>1. From June 30, 2010 to July 13, 2014, we did not have any land use rights certificate for a parcel of collective-owned land with an area of approximately 7,153.3 sq. meters in Dongguan, the PRC (the “Dongguan Dormitory Land”). We also did not have the real estate ownership certificate for a building on the Dongguan Dormitory Land which we use as employee dormitories and canteen with an aggregate gross floor area of approximately 5,388.7 sq. meters (the “Dormitories”). The Dormitories were constructed without the requisite construction planning permit and construction commencement permit. To clarify, none of our production facilities in Dongguan are located on the Dongguan Dormitory Land.</p>	<p>The Dongguan Dormitory Land and the Dormitories did not have the said certificates as we purchased them from an Independent Third Party on June 30, 2010 who had not obtained the said certificates.</p>	<p>As advised by our PRC Legal Advisers, an entity occupying land without the requisite land use rights certificate may be ordered by the holder of the land use rights to surrender such land, and the structures and installations built on such land shall be confiscated.</p> <p>Our PRC Legal Advisers also advised that an entity occupying the construction without necessary construction planning permit and construction commencement permit may be (i) requested by the relevant authorities to take remedial actions within a certain period of time, (ii) requested to demolish the construction, and/or (iii) subject to a fine of up to 22% of the construction fees (建設工程造價).</p> <p>We may be subject to an estimated maximum fine of RMB469,040 for occupying a building constructed without construction planning permit nor construction commencement permit based on the construction fees of the Dormitories of RMB2.13 million.</p>	<p>On July 14, 2014, we obtained the collective-owned land use rights certificate for the Dongguan Dormitory Land from Dongguan Municipal People’s Government (東莞市人民政府).</p> <p>Subsequently, we obtained written confirmation from relevant authorities, being Dongguan Hengli Office for Handling Real Estate Rights of Completed Properties (東莞市橫瀝鎮已建房屋補辦房地產權手續工作辦公室), Dongguan Office for Handling Real Estate Rights of Completed Properties (東莞市已建房屋補辦房地產權手續工作辦公室) and Dongguan Municipal People’s Government Office (東莞市人民政府辦公室), that we were authorized to proceed to obtain the real estate ownership certificate for the Dormitories.</p>
<p>With such authorization, we may proceed to obtain the construction commencement permit and construction planning permit for the Dormitories. We obtained the construction planning permit and the house safety inspection certificate. As advised by our PRC Legal Advisers, pursuant to the Details of Implementation for the Application of Real Estate Ownership Certificate for Buildings Constructed in Dongguan (《東莞市已建房屋補辦房地產權證實施細則》) issued in 2009 by Dongguan Municipal People’s Government (東莞市人民政府), buildings that completed construction prior to September 1, 2001 should obtain the house safety inspection certificate in substitution of the construction commencement permit when applying for the real estate ownership certificate. The construction of the Dormitories was completed in October 1999. As such, we should obtain the house safety inspection certificate and did so accordingly.</p>	<p>We had previously paid a fine of RMB29,638 to the Bureau of Housing and Urban-Rural Development of Dongguan (東莞市住房和城鄉建設局) for not obtaining the construction commencement permit for the Dormitories.</p>	<p>With such authorization, we may proceed to obtain the construction commencement permit and construction planning permit for the Dormitories. We obtained the construction planning permit and the house safety inspection certificate. As advised by our PRC Legal Advisers, pursuant to the Details of Implementation for the Application of Real Estate Ownership Certificate for Buildings Constructed in Dongguan (《東莞市已建房屋補辦房地產權證實施細則》) issued in 2009 by Dongguan Municipal People’s Government (東莞市人民政府), buildings that completed construction prior to September 1, 2001 should obtain the house safety inspection certificate in substitution of the construction commencement permit when applying for the real estate ownership certificate. The construction of the Dormitories was completed in October 1999. As such, we should obtain the house safety inspection certificate and did so accordingly.</p>	<p>We had previously paid a fine of RMB29,638 to the Bureau of Housing and Urban-Rural Development of Dongguan (東莞市住房和城鄉建設局) for not obtaining the construction commencement permit for the Dormitories.</p>

BUSINESS

Non-compliance incidents	Reasons	Legal consequences and potential maximum penalties	Remedial actions and current status
<p>Furthermore, as of the Latest Practicable Date, we had surrendered the collective-owned land use rights certificate of the Dongguan Dormitory Land and are using such land without the certificate.</p>	<p>To expand the PRC operations to accommodate our Group's future development, we filed the Application to change the nature of the Dongguan Dormitory Land from collective-owned land to state-owned land as the permitted use of collective-owned land is limited⁽¹⁾. Between December 2015 and December 2017, relevant authorities approved our Application and the collective-owned land use rights certificate of the Dongguan Dormitory Land was surrendered to the relevant authorities. Accordingly, our collective-owned land use rights certificate for the Dongguan Dormitory Land was deregistered thereafter, pending results of the tender invitation, auction and listing process or any other relevant application procedures as instructed by the relevant authorities from time to time (the "Land Grant Process")⁽²⁾.</p>	<p>As advised by our PRC Legal Advisers, an entity whose land use rights have been expropriated will no longer be entitled to enjoy the right to use the land nor the ownership of the structures and installations thereon, and may be ordered by the holder of the land use rights to surrender such land and structures and installations erected thereon if it continues to occupy the land or use the structures and installations thereon.</p>	<p>We did not proceed to obtain the real estate ownership certificate for the Dormitories as we have subsequently filed an application for land purchase and storage (土地收購申請) on June 3, 2015 (the "Application") to change the nature of the Dongguan Dormitory Land from collective-owned land to state-owned land. After filing the Application, we were required to surrender the collective-owned land use rights certificate pending the tender invitation, auction and listing process. As the collective-owned land use rights certificate had been surrendered, we could not obtain the real estate ownership certificate.</p>
<p>Our PRC Legal Advisers are of the view that there will be no further penalties or legal consequences to the Group for previously not possessing the collective-owned land use rights certificate for the Dongguan Dormitory Land and currently not possessing the real estate ownership certificate for the Dormitories, for the following reasons: (i) we obtained the collective-owned land use rights certificate for the Dongguan Dormitory Land, (ii) we obtained a confirmation issued by the relevant competent authorities that we were authorized to proceed to obtain the real estate ownership certificate for the Dormitories, (iii) we have paid a fine with respect to certificate defect of the Dormitories and have obtained the construction planning permit and the house safety inspection certificate, and (iv) the two-year period statute of limitations for relevant authorities to impose any fine on the matter has lapsed.</p>	<p>As mentioned, since we were required to surrender the collective-owned land use rights certificate as part of the Land Grant Process, we are currently occupying the Dongguan Dormitory Land without land use rights certificate, pending the tender invitation, auction and listing process.</p>	<p>As of the Latest Practicable Date, no administrative sanctions, fine or penalty had been taken or imposed on us by the relevant authorities with respect to a lack of the requisite land use rights and the real estate ownership certificate.</p>	

BUSINESS

Non-compliance incidents	Reasons	Legal consequences and potential maximum penalties	Remedial actions and current status
			<p>At interviews with Dongguan Hengli Industrial Co., Ltd. (東莞橫瀝實業有限公司)⁽³⁾ on July 25, 2017 and with the Investment Office of Dongguan Hengli People's Government (東莞市橫瀝鎮人民政府投資辦公室) on August 24, 2017, we obtained confirmation to continue to use the Dongguan Dormitory Land and the Dormitories pending completion of the Land Grant Process.</p> <p>Based on the above, our PRC Legal Advisers are of the view that the risks of our being ordered to surrender the Dongguan Dormitory Land by the relevant authorities pending results of the Land Grant Process is low.</p> <p>As the Land Grant Process is a process that is open to public and involving other third party participants, neither we nor our PRC Legal Advisers are able to determine or assess the chance for which our Company will succeed in obtaining ownership of the Dongguan Dormitory Land upon completion of the Land Grant Process.</p> <p>Our Directors are of the view that the maximum amount of premium we are willing to pay for the Dongguan Dormitory Land (including the Dormitories thereon) at the Land Grant Process will not have a material financial impact on our Group after taking into account of our Group's total assets as at December 31, 2017. In the event we cannot successfully obtain the state-owned land use rights of the Dongguan Dormitory Land under the Land Grant Process, we may be required to relocate the Dormitories and transfer the Dongguan Dormitory Land to the successful bidder. Our Directors believe that relocation costs involved are immaterial and replacements are readily available and the relocation of the Dormitories is not expected to have any material adverse effect on our operation, financial position or operating results.</p>

BUSINESS

	Non-compliance incidents	Reasons	Legal consequences and potential maximum penalties	Remedial actions and current status
2.	<p>Since September 6, 2010 when we obtained the land use rights for the parcel of land in Dongguan, the PRC with a site area of 31,999.05 sq. meters (the “Dongguan Plant Land”), we did not have the real estate ownership certificate for one of our warehouses on the Dongguan Plant Land. We also did not have the real estate ownership certificate of another one of our warehouses on the Dongguan Plant Land which we completed construction in 2012 (collectively, the “Dongguan Warehouses” and each a “Dongguan Warehouse”). The Dongguan Warehouses have an aggregate gross floor area of 1,608 sq. meters. We also have not completed filing of the requisite construction completion reports and archives to the authorities.</p>	<p>We commenced construction of the Dongguan Warehouses without obtaining the required construction planning permit and construction commencement permit because we were not adequately advised on the relevant laws and regulations in relation to such construction and misunderstood that such construction was permitted.</p> <p>Without the said permits, we are unable to obtain the real estate ownership certificate.</p>	<p>Our PRC Legal Advisers advised that an entity commencing construction or occupying the construction without the requisite construction planning permit and construction commencement permit and failing to complete the filing of the requisite construction completion reports and archives to the relevant authorities may be (i) requested by the relevant authorities to take certain remedial actions within a certain period of time, (ii) requested to demolish the construction, and (iii) subject to a fine of up to 22% of the construction fees (建設工程造價) plus an amount of up to RMB600,000 per building/warehouse.</p> <p>We may be requested to demolish the Dongguan Warehouses, upon expiry of the temporary construction permit, if applicable and be imposed with a fine of up to RMB1,321,000 based on the construction fees of the Dongguan Warehouses of RMB550,000.</p>	<p>As of the Latest Practicable Date, no administrative sanctions, fine or penalty had been taken or imposed on us by the relevant authorities with respect to commencing construction without construction planning permit and construction commencement permit for the Dongguan Warehouses and unable to complete the filing of necessary construction completion reports and archives to the authorities.</p> <p>On December 15, 2017, we obtained a temporary construction permit for a period of two years for one of the Dongguan Warehouses. In addition, we are concurrently communicating with and have submitted the application to relevant authorities to obtain a temporary construction permit for the other Dongguan Warehouse. If we are able to obtain a temporary construction permit, which is generally issued for a two-year period with a possible extension of one year upon expiry, we may continue to occupy the other Dongguan Warehouse for the period of the permit. If we are unable to do so, we intend to relocate the raw materials and finished products stored in the other Dongguan Warehouse to our other properties, and lease other warehouse premises, as necessary. According to our PRC Legal Advisers, it is uncertain whether the Group will obtain the temporary construction permit for the other Dongguan Warehouse, and if the Group obtains the permit, the risks of the Group being imposed a fine would be low. Upon expiry of the temporary construction permit, we are required to demolish the Dongguan Warehouses and relocate the raw materials and finished goods stored in the Dongguan Warehouses. Our Directors believe that demolition and relocation costs involved, if we receive such demolition order, are immaterial and will not have any material and adverse effect on our operation, financial position or operating results.</p>

BUSINESS

Non-compliance incidents	Reasons	Legal consequences and potential maximum penalties	Remedial actions and current status
<p>3. During the Track Record Period, there were unauthorized building works, namely two diesel tanks of less than 2,500 liters in aggregate, on the rooftop of our factory plant in Kwai Chung.</p> <p>The commencement of such unauthorized building works without the approval of the Buildings Department contravenes section 14(1) of the Buildings Ordinance.</p>	<p>The said works occurred due to the absence of timely and professional advice at the material time.</p>	<p>The Building Authority may issue building order requiring the premises owner, i.e. TWHK, to demolish the unauthorized structure before a specified date. Any non-compliance with such order will subject the directors of TWHK to:</p> <ul style="list-style-type: none"> (a) a fine of HK\$400,000 and imprisonment for 2 years; and (b) a fine of HK\$20,000 for each day of continuing offence. 	<p>The diesel tanks have been demolished soon after the non-compliance was discovered. As such, Hong Kong Special Counsel considers it clearly unlikely that the Group will be charged for failing to comply with any building order given none has been issued so far. Diesel is now directly pumped from a cylindrical diesel container of 220 liters in the factory plant to the coffee roasters. As advised by the Hong Kong Special Counsel, the current arrangements should not violate the Hong Kong laws or regulations in any material respects or require any licence or approval from government authorities. We have assigned our production manager to closely monitor the above arrangements on a daily basis.</p> <p>As of the Latest Practicable Date, TWHK did not receive any building order from the Building Authority. As advised by the Hong Kong Special Counsel, given our above remedial action, the chance of TWHK being prosecuted is slim.</p>

BUSINESS

Notes:

- (1) According to our PRC Legal Advisers, the key difference between collective-owned land and state-owned land is that any transfer of, construction on or mortgage of, collective-owned land requires the consent from at least two-thirds of village representatives or the members of a collective economic organization (集體經濟組織成員的村民), while the transfer of, construction on and mortgage of, state-owned land can be done in accordance with the land grant contract which is generally less stringent. In addition, according to the relevant regulations of Dongguan, collective-owned land can be used for industrial purposes. However, according to the Land Administration Law of the People's Republic of China (中華人民共和國土地管理法), collective-owned land cannot be used for purposes other than agriculture. Due to conflict of regulations at the central government level and the local government level of China in relation to whether collective-owned land can be used for industrial purposes, there is uncertainty as to the legal implication of such conflict of regulations governing collective-owned land.
- (2) According to our PRC Legal Advisers, the Land Grant Process can be conducted by way of tender invitation, auction or listing, and generally involves the following procedures: (i) the competent authority publishes announcement with details of the state-owned land to be granted; (ii) potential investors submit their proposal; (iii) the competent authority conducts background check on the potential investors; and (iv) the competent authority undergoes the relevant procedures of tender invitation, auction and listing. Tender invitation includes the collection, opening, assessment, selection of bid and issue of notice for successful bid. Auction includes publishing details of auction, conducting the auction according to auction rules and signing of confirmation letter with the successful bidder. Listing includes announcing information about the listing, submission of quotation by potential investors, confirmation of quotation and signing of confirmation letter with the successful bidder. The successful bidder will enter into a land grant contract with the competent authority and proceed to land registration after payment of bid.
- (3) Our PRC Legal Advisers advised that Dongguan Hengli Industrial Co., Ltd. (東莞橫瀝實業有限公司) (“**Dongguan Hengli**”) is not an organization under the PRC government. However, our PRC Legal Advisers are of the view that Dongguan Hengli is in a position to confirm that we can continue to use the Dongguan Dormitory Land and the Dormitories pending completion of the Land Grant Process as (i) we entered into agreements governing the terms for surrendering the Dongguan Dormitory Land and the Land Grant Process with Dongguan Hengli; and (ii) according to the interview with the Investment Office of Dongguan Hengli People's Government (“**Hengli Investment Office**”), Hengli Investment Office confirmed that Dongguan Hengli and itself are responsible for coordinating the work in relation to the expropriation and the Land Grant Process of the Dongguan Dormitory Land and the Dormitories. Hengli Investment Office is a department within the PRC government and confirmed that it can opine on the matter during the interview.

BUSINESS

For incidents 1 and 2, based on the disclosure above and that (i) these properties with defective titles are not individually or collectively crucial to our operations; (ii) we can find comparable properties to relocate the Dormitories or the Dongguan Warehouses or relocate to our other self-owned properties, if necessary; and (iii) we do not anticipate any material practical difficulties in relocating the Dormitories or the Dongguan Warehouses and the estimated time and cost for relocation are immaterial, our Directors consider that none of the non-compliance matters disclosed above will have any material and adverse effect on our operation, financial condition or operating results. Having considered the facts and circumstances leading to the above non-compliance incidents, we have implemented certain internal control measures to avoid the future recurrence of such non-compliance incidents. For further details, please refer to “— Internal Control and Risk Management” in this section.

Our Controlling Shareholders have entered into the Deed of Indemnity whereby our Controlling Shareholders have agreed to indemnify our Group, subject to the terms and conditions of the Deed of Indemnity, in respect of all damages, penalties, fees, expenses, losses as a result of any violation of or non-compliance by any member of the Group with any applicable law, rule or regulation on all matters subsisting prior to the date on which the conditions set out in the section headed “Structure of the Global Offering — Conditions of the Hong Kong Public Offering” in this prospectus being fulfilled. Further details of the Deed of Indemnity are set out in the paragraph headed “E. Other information — 1. Tax and other indemnity” in Appendix IV to this prospectus.

Views of our Directors and the Joint Sponsors

After taking into account the nature of and reasons for the historical non-compliance incidents disclosed above, and that our Group has taken measures to rectify such non-compliances and has adopted measures to prevent future breach, the written confirmations of the relevant competent government authorities, the legal consequences of such non-compliance incidents, our business nature and operation scale, our Directors are of the view, and the Joint Sponsors concur with our Directors’ view, that we have adequate and effective internal control procedures in place and in accordance with the requirements under the Listing Rules, and the non-compliance incidents disclosed above will not affect the suitability of our Directors to act as directors of a listed issuer under Rules 3.08, 3.09 and 8.15 of the Listing Rules and/or the suitability for Listing of our Company under Rule 8.04 of the Listing Rules.

DISCONTINUED OPERATION

During the Track Record Period, we engaged in the manufacturing and wholesale of ice-cream and operation of retail shops through the Elect Gold Group. On May 31, 2016, we disposed of the entire equity interest in Elect Gold to Hero Ace Limited, a company wholly-owned by Mr. Wong, in order to focus our resources on our existing businesses. For further details, please refer to the section headed “History, Development and Corporate Structure — Material Development after Delisting — (b) Incorporation, Acquisitions and Disposal of Elect Gold” in this prospectus.

FINANCIAL INFORMATION

You should read the following discussion and analysis with our consolidated financial information, including the notes thereto, as of and for the years ended December 31, 2015, 2016, and 2017 included in the Accountants' Report set out in Appendix I to this prospectus. The financial information included in the Accountants' Report has been prepared in accordance with HKFRSs. The following discussion and analysis and other parts of this prospectus contain forward-looking statements that reflect our current views with respect to future events and financial performance that involve risks and uncertainties. These statements are based on assumptions and analysis made by us in light of our experience and perception of historical events, current conditions and expected future developments, as well as other factors we believe are appropriate under the circumstances. In evaluating our business, you should carefully consider the information provided in the section headed "Risk Factors" in this prospectus.

OVERVIEW

We are a leading integrated B2B coffee and black tea solutions provider in Hong Kong, Macau and the PRC with an established food products business. Our 85-year heritage originates from an outlet providing coffee roasting and trading of coffee and tea in 1932. Since then, we have grown into a well-trusted brand in Hong Kong, Macau and the PRC providing one-stop coffee and tea solutions services to commercial customers that cover the entire coffee and tea procurement, processing and distribution value chain, with an expertise on Hong Kong-style milk tea. While in the PRC, we have established a stable beverage solutions business, which we believe has good growth potential as reflected in our financial results for the year ended December 31, 2017. With a view to better serve our customers, we broadened our business scope and commenced our frozen meat business in Hong Kong and the PRC in 2013 and frozen processed food business in Hong Kong in 2015 and in the PRC in 2016. We have developed a stable and diverse group of customers that include renowned food and beverage service providers. Together with our customers, we catered to generations of end consumers in the regions we serve and successfully evolved to meet changing consumer tastes.

Our diverse customer base also gives us a multi-channel distribution network that can reach approximately 60% of the food outlets in Hong Kong in 2016. We broadened our business scope to provide food supplies to our B2B customers and commenced our frozen meat business in Hong Kong and the PRC in 2013, and our frozen processed food business in Hong Kong in 2015 and in the PRC in 2016. Going forward, we aim to provide frozen meat and frozen processed food to our customers and integrate such products into our customer's central kitchen. We entered into a strategic cooperation agreement in July 2017 with a leading food provider, NH Foods, which has operations in about 90 locations in 19 countries and regions, to jointly develop the food products market in Hong Kong, Macau and the PRC. We believe that our market knowledge and well-established customer base combined with NH Foods's expertise in food products, experience and resource strengthens our product portfolio and positions us well to develop targeted markets in Hong Kong, Macau and the PRC, including meeting the demand of tailor made products to our B2B customers in the fast food market. Furthermore, we entered into a memorandum of

FINANCIAL INFORMATION

understanding with F&N in April 2018 to explore business and product development opportunities for the supply, distribution, co-branded promotion and co-development of beverage products and/or beverage solutions.

FACTORS AFFECTING OUR RESULTS OF OPERATIONS

Our results of operations have been and will continue to be affected by a number of factors, including the following:

Conditions in the markets where we operate

We derive substantially all of our revenue from sales of food and beverage products in Hong Kong and the PRC. Macroeconomic conditions in Hong Kong and the PRC, including levels of consumer spending and disposable income, affect our customers' demand for our products. From 2012 to 2016, the Hong Kong economy experienced nominal GDP growth from HK\$2,037.1 billion to HK\$2,491.0 billion, representing a CAGR of 5.2%, while the PRC economy experienced nominal GDP growth of RMB54.0 trillion to RMB74.4 trillion, representing a CAGR of 8.3%. In addition, influenced by the recovery of economy, the nominal GDP per capita in Hong Kong increased from HK\$284,900 in 2012 to HK\$339,500 in 2016, representing a CAGR of 4.5%. However, we cannot be certain that any downturn in the future would not have a negative impact on our results of operations. In addition, our sales are closely tied to the performance of the food and beverage markets, in particular the coffee and tea beverage markets in Hong Kong and the PRC. According to Frost & Sullivan, the Hong Kong and PRC food and beverage markets are expected to continue to grow rapidly and we are expected to benefit from this growth trend. However, a variety of factors and uncertainties may affect the Hong Kong and the PRC food and beverage markets, including higher demand for customized products and services, growing popularity of healthy food and beverages, preference towards sales through e-commerce channel, rigorous PRC regulatory environment, and increasing environmental awareness. If the Hong Kong and the PRC food and beverage markets do not expand as forecasted and/or our operations experience adverse changes, our business, financial condition and results of operations would be adversely affected accordingly.

Customer demand and brand recognition

We currently sell our coffee and tea products under our "TW" brand. We believe that the popularity of our brand has helped to attract our target consumers and position us as a leading integrated B2B coffee and black tea solutions provider in Hong Kong, Macau and the PRC with an established food products business. As such, we believe that market recognition of our brands is critical to our success as market acceptance of our brands may affect the demand for our products, prices and the gross margin we are able to achieve and our ability to further grow our business. For the years ended December 31, 2015, 2016 and 2017, our marketing and promotion expenses amounted to approximately HK\$14.7 million, HK\$17.1 million and HK\$18.3 million, respectively. In the future, we intend to devote more resources in our marketing and advertising activities with multi-faceted marketing strategies including traditional advertising channels to increase the recognition and awareness of our brands and products by consumers. Our success will depend on our ability to continue to enhance the awareness of our brands. If we are unable to promote our brands or fail to

FINANCIAL INFORMATION

maintain our current brand position, market perception and consumer acceptance of our brands may weaken, and our business, financial condition and results of operations may be materially and adversely affected.

Raw material cost

Raw material cost is one of our major costs. Our operation heavily relies on a stable supply of raw materials, including coffee beans, processed tea leaves and milk for production of beverage products and imported frozen meat and frozen processed food for our food products business. For the years ended December 31, 2015, 2016 and 2017, purchase of our raw materials (including packaging materials) accounted for 95.0%, 94.5% and 95.1% of our total cost of sales, respectively. Our ability to obtain a stable supply of raw materials at competitive prices affects our profitability and our overall operating performance. One of our most important raw materials is coffee beans. During the Track Record Period, our profitability generally strengthened when the price of coffee beans decreased. For instance, our average procurement price of coffee beans decreased by 11.5% from HK\$10.4 per lb in 2015 to HK\$9.2 per lb in 2016, and the gross profit margin for our coffee products increased by 4 percentage points for 2016 as compared to that of 2015. Unexpected commodity price increases may result in increases in the costs of our raw materials. While we have implemented hedging measures, if we are not able to pass any or all of the unhedged increase in raw material costs to our customers in the future, our profit and profit margin could be adversely affected. For further details, please refer to the section headed “Business — Customers — Pricing — Raw Material Price Management” in this prospectus.

The following tables illustrate the sensitivity analysis of the respective estimated increase/decrease of the gross profit in relation to changes to the prices of coffee beans and processed tea leaves. The sensitivity analysis assumes that only one variable changes while other variables remain unchanged. The analysis is intended for reference only, and any variation may differ from the amounts indicated. For details on historical price fluctuation of coffee beans and processed tea leaves, please refer to the section headed “Industry Overview — Raw Materials” in this prospectus. Over the Track Record Period, sales from coffee and tea products constitute a substantial portion of our total revenue, thus we believe an analysis of the impact from changes to the prices of coffee beans and processed tea leaves on the estimated change of the gross profit illustrate how our business may be affected by changes in raw material prices.

% Change in our average purchase price of coffee beans	For the year ended December 31,					
	2015		2016		2017	
	Change in Gross Profit (HK\$'000)	% Change in Gross Profit	Change in Gross Profit (HK\$'000)	% Change in Gross Profit	Change in Gross Profit (HK\$'000)	% Change in Gross Profit
10%	(8,458)	(9.6)%	(7,213)	(7.7)%	(7,817)	(8.9)%
5%	(4,229)	(4.8)%	(3,607)	(3.9)%	(3,909)	(4.5)%
0	—	—	—	—	—	—
-5%	4,229	4.8%	3,607	3.9%	3,909	4.5%
-10%	8,458	9.6%	7,213	7.7%	7,817	8.9%

FINANCIAL INFORMATION

% Change in our average purchase price for processed tea leaves	For the year ended December 31,					
	2015		2016		2017	
	Change in Gross Profit (HK\$'000)	% Change in Gross Profit	Change in Gross Profit (HK\$'000)	% Change in Gross Profit	Change in Gross Profit (HK\$'000)	% Change in Gross Profit
10%	(8,867)	(9.6)%	(8,596)	(9.1)%	(11,188)	(11.2)%
5%	(4,433)	(4.8)%	(4,299)	(4.6)%	(5,594)	(5.6)%
0	—	—	—	—	—	—
-5%	4,433	4.8%	4,299	4.6%	5,594	5.6%
-10%	8,867	9.6%	8,596	9.1%	11,188	11.2%

Seasonality

We experience seasonal fluctuations in demand for our products. Historically, we have experienced higher sales of our products such as frozen meat and beverages in the first and fourth quarters of each calendar year where there are holiday seasons such as Chinese New Year and Christmas. As a result, comparisons of our sales and operating results between different periods within a single financial year are not necessarily meaningful and cannot be relied on as indicators of our performance. Our results of operations are likely to continue to fluctuate according to seasonality.

Product and service mix

We provide tailor-made beverage solutions that cater to the taste of our customers and end users. We work closely with our customers to develop coffee and tea blends with different aroma, richness, and taste characteristics to suit the patrons of our customers' food and beverage outlets. Moreover, we entered into the food products market following by an acquisition in 2013. For further details, please refer to the section headed "History, Development and Corporate Structure — Our Corporate Development — (a) Major subsidiaries of TWIC — Whole Sun" in this prospectus. We believe that a diverse product and service mix enables us to cater to different markets and expand our revenues. At the same time, the profit margin of our product and services varies according to its nature and technical specifications as well as the competitive landscape of its market segment. Changes in the mix of products we sell and services we offer will impact our sales and profitability. For instance, for the year ended December 31, 2016, our coffee, tea and milk products had the highest gross profit margin of 49.2%, 49.2% and 29.2%, respectively, which contributed to the highest gross profit margin of 32.3% in 2016 during the Track Record Period. We have adjusted and will continue to adjust our product mix from time to time to cope with changing market demands and to improve our profitability. Our diversified product portfolio enables us to capture changes in market trends and consumer preferences in the markets we serve.

Sales volume, capacity expansion and capacity utilization

Our results of operations have been and will continue to be affected by our sales volume and ability to leverage our production capacity to capture growing demand for food and beverage products. Our results of operations are directly affected by our sales volume.

FINANCIAL INFORMATION

Our ability to expand production capacity affects our sales volume because potential customers often place orders only after they have received adequate assurance that a food and beverage provider has sufficient capacity to meet such demand. The utilization rate at our production facilities in Hong Kong had been high, and in light of such situation, we have expanded and will continue to expand the scale of our operations by upgrading existing production facilities, purchasing additional manufacturing equipment and/or seeking opportunities to acquire companies that fit into our expansion plan if applicable. We believe our capacity expansion, particularly the opening of facility in Dongguan, the PRC, has enabled and will enable us to better serve our customers and grow our sales. For further details, please refer to the section headed “Business — Production — Production Facilities” in this prospectus.

We believe that our future operating results will depend on our ability to maintain sufficient operation at our production plants. If we are unable to maintain high utilization rates at our production plants, or if we are not able to manufacture sufficient products to meet the orders of our customers, or if we do not have sufficient capacity to meet our customers’ demand, our business, results of operations and financial condition may be materially and adversely affected.

Sales and distribution network

Our sales volume is directly affected by the level of our penetration in various geographic markets, which in turn is affected by the size of our sales and distribution network. We have an extensive and strategically designed sales and distribution network in Hong Kong and the PRC. We sell our products through direct relationships with our customers, particularly to key customers. For the years ended December 31, 2015, 2016 and 2017, revenue from direct sales represented 92.8%, 92.5% and 91.7%, of our total revenue, respectively. We believe that such direct relationships with our customers provide us with a platform to gather first-hand market feedback from consumers, increase our sales, as well as improve our brand recognition and access a broader base of consumers.

In order to deepen our market penetration, we also work with our distributors to expand the availability of our products to our customers. We benefit from the stability of our relationships with our distributors, with whom we have well-established business relationships. As of December 31, 2015, 2016 and 2017, we had 162, 170 and 157 distributors, respectively. We believe our ability to grow our business will depend on us continuing to maintain and manage an effective sales and distribution network. In order to support the growth of our business and strengthen our market competitiveness, we plan to continue to expand our sales and distribution network.

Competition and product pricing

We are positioned as a leading integrated B2B coffee and black tea solutions provider in Hong Kong, Macau and the PRC with an established food products business. We face competition from a number of domestic and international food and beverage service providers, and we expect competition to intensify with new suppliers entering into the market in future. We believe we have been able to maintain our pricing at a premium to our competitors because of the food safety measures we implemented to produce quality

FINANCIAL INFORMATION

products and services and our ability to provide customized products that meets the specific needs of our customers. However, going forward, competition with other market participants may have a substantial effect on our product pricing as we strive to competitively price our products in order to grow or maintain our market share while balancing our profitability targets. If our competitors improve their offerings, merely providing superior quality products and services by us may not be sufficient to maintain or increase our market share. In addition to the pricing strategy of competitors, other factors affecting how we price our products and services include market demand, market share, raw material costs, production costs, product categories, spending patterns of target consumers and expected profit margin. For further details regarding competition, please refer to the section headed “Risk Factors — Risks Relating to Our Industry — We operate in a highly competitive industry and may face increased competition in the future.” in this prospectus.

BASIS OF PRESENTATION

Our consolidated financial statements have been prepared in accordance with HKFRSs and accounting principles generally accepted in Hong Kong. They have been prepared under the historical cost convention except for a financial investment at fair value through profit or loss which has been measured at fair value. These financial statements are presented in Hong Kong dollars and all values are rounded to the nearest thousand except when otherwise indicated.

CRITICAL ACCOUNTING POLICIES

The preparation of our financial information and related notes requires us to make judgments, estimates and assumptions that affect the reported amounts of assets, liabilities, revenue and expenses and other financial data. We have based our estimates on historical experience and on various other assumptions that we believe to be reasonable under the circumstances, the results of which form the basis for making judgments about the carrying values of assets and liabilities that are not readily apparent from other sources. Our management has discussed the development, selection and disclosure of these estimates with our Directors. Actual results may differ from these estimates under different assumptions or conditions.

An accounting policy is considered to be critical if it requires an accounting estimate to be made based on assumptions about matters that are highly uncertain at the time the estimate is made, and if different estimates that reasonably could have been used, or changes in the accounting estimates that are reasonably likely to occur periodically, could materially impact the consolidated financial information. Details of our significant accounting policies are set forth in Note 2.3 of the Accountants’ Report in Appendix I to this prospectus.

FINANCIAL INFORMATION

SUMMARY OF FINANCIAL INFORMATION

The following table sets out a summary of our consolidated statements of profit or loss for the years ended December 31, 2015, 2016, and 2017, which is extracted from the Accountants' Report as set out in Appendix I to this prospectus. Potential investors should read this section in conjunction with the Accountants' Report of our Group contained in Appendix I to this prospectus and not rely merely on the information contained in this section.

	Year ended December 31,		
	2015	2016	2017
	<i>(HK\$'000)</i>	<i>(HK\$'000)</i>	<i>(HK\$'000)</i>
CONTINUING OPERATIONS			
Revenue	838,152	849,720	954,610
Cost of sales	<u>(591,748)</u>	<u>(575,626)</u>	<u>(664,996)</u>
Gross profit	246,404	274,094	289,614
Other income and gains, net	17,277	17,061	3,998
Selling and distribution expenses	(97,480)	(108,890)	(112,245)
Administrative expenses	(89,896)	(86,774)	(109,743)
Other expenses, net	(12,000)	(9,844)	(3,325)
Finance costs	<u>(4,875)</u>	<u>(4,006)</u>	<u>(4,126)</u>
Profit before tax from continuing operations	59,430	81,641	64,173
Income tax expense	<u>(12,843)</u>	<u>(17,401)</u>	<u>(15,799)</u>
Profit for the year from continuing operations	46,587	64,240	48,374
DISCONTINUED OPERATION			
(Loss)/profit for the year from a discontinued operation	<u>(7,131)</u>	<u>1,463</u>	<u>—</u>
Profit for the year	<u>39,456</u>	<u>65,703</u>	<u>48,374</u>

FINANCIAL INFORMATION

	Year ended December 31,		
	2015 (HK\$'000)	2016 (HK\$'000)	2017 (HK\$'000)
Attributable to:			
Owners of the parent			
Profit for the year from continuing operations	48,009	63,243	46,095
(Loss)/profit for the year from a discontinued operation	<u>(6,762)</u>	<u>1,703</u>	<u>—</u>
Profit for the year	<u>41,247</u>	<u>64,946</u>	<u>46,095</u>
Non-controlling interests			
(Loss)/profit for the year from continuing operations	(1,422)	997	2,279
Loss for the year from a discontinued operation	<u>(369)</u>	<u>(240)</u>	<u>—</u>
(Loss)/profit for the year	<u>(1,791)</u>	<u>757</u>	<u>2,279</u>
	<u>39,456</u>	<u>65,703</u>	<u>48,374</u>

Other Financial Measure

	Year ended December 31,		
	2015 HK\$'000 (unaudited)	2016 HK\$'000 (unaudited)	2017 HK\$'000 (unaudited)
Adjusted profit for the year from continuing operations attributable to owners of the parent ⁽¹⁾	<u>51,460</u>	<u>62,037</u>	<u>76,657</u>

- ⁽¹⁾ Adjusted profit for the year from continuing operations attributable to owners of the parent is a non-HKFRS financial measurement which, in the opinion of our Directors, eliminates the effect of a number of non-recurring income, costs and charges and certain of other non-cash charges that affect our reported profit from continuing operations attributable to owners of the parent, including (i) Listing expenses; (ii) consultancy fee incurred for change in the nature of land use rights and formation of development plan of a piece of land in Dongguan; (iii) legal fees incurred for settled trademark litigation; (iv) impairment loss and write-down of inventories in phasing out the current model of milk tea machines; (v) write-down in value of coffee pod machines inventories; (vi) impairment of trade receivables and write-down of inventories from discontinued prune business in the PRC; (vii) dividend income from an available-for-sale investment; (viii) interest income earned from the ultimate holding company; (ix) compensation from settled litigation; and (x) compensation received from a supplier, and excluding any tax effects related to the preceding judgements.

FINANCIAL INFORMATION

The following table sets out the reconciliation from our profit for the year from continuing operations attributable to owners of the parent to adjusted profit for the year from continuing operations attributable to owners of the parent:

	Year ended December 31,		
	2015	2016	2017
	<i>HK\$'000</i>	<i>HK\$'000</i>	<i>HK\$'000</i>
Profit for the year from continuing operations attributable to owners of the parent	<u>48,009</u>	<u>63,243</u>	<u>46,095</u>
Plus/(minus):			
Listing expenses	—	—	24,974
Consultancy fee for land use rights and development plan in Dongguan	6,007	6,007	6,007
Legal fees incurred for settled trademark litigation	3,963	2,755	—
Impairment loss and write-down of inventories in phasing out the current model of milk tea machines	—	6,390	—
Write-down in value of coffee pod machines inventories	3,058	—	—
Impairment of trade receivables and write-down of inventories relating to discontinued prune business in the PRC	4,022	650	—
Dividend income from an available-for-sale investment	(385)	(519)	—
Interest income earned from the ultimate holding company	—	(489)	(419)
Compensation from settled litigation	(9,958)	(16,000)	—
Compensation received from a supplier	<u>(3,256)</u>	<u>—</u>	<u>—</u>
Adjusted profit for the year from continuing operations attributable to owners of the parent	<u><u>51,460</u></u>	<u><u>62,037</u></u>	<u><u>76,657</u></u>

FINANCIAL INFORMATION

During the Track Record Period, we incurred consultancy fee of approximately HK\$18.0 million, and there will not be any amount to be further incurred afterwards. On December 15, 2014, our Group engaged a consultant to provide consultancy services in respect of the formation of development plan of a piece of land in Dongguan (“**Dongguan Land**”) and change in the nature of its land use rights with a term of three years. The consultant is an Independent Third Party, who was a member of the 9th Guangdong Provincial Committee of the Chinese People’s Political Consultative Conference (中國人民政治協商會議廣東省委員會) and member of Hong Kong–Guangdong Community Association (香港廣東社團總會), Guangdong Overseas Chinese Enterprises Association (廣東省僑商投資企業協會) and Hong Kong Guangdong Foreign Businessmen Association (香港廣東外商工會), which liaise with the government authorities for promoting economic development in China and Hong Kong. As a member of a number of business associations in Hong Kong and Guangdong areas, at the time of the engagement, our Chairman was of the view that the consultant can provide significant guidance and assistance in the development of our Group’s PRC business as well as the business connection in China to navigate the development of our Group’s business in the PRC.

When determining the consultancy fee, the following factors have been taken into account (i) the time proposed to be devoted by the consultant for each task to be performed by him and/or his employees; and (ii) the importance of formation and implementation of a development plan with respect to the land to execute our Group’s long-term business expansion for building various facilities such as a tea processing plant and a food product processing plant. Summary of the material terms of the Consultancy Service Agreement (as defined below) are as follows:

Date of the consultancy service agreement (as supplemented by a supplemental agreement dated 24 June 2016) (the “ Consultancy Service Agreement ”):	December 15, 2014
Parties:	TWIC and the consultant
Term of the Consultancy Service Agreement:	3 years from January 2, 2015
Total fee:	Approximately HK\$18.0 million
Payment terms:	Payable in 4 instalments: <ul style="list-style-type: none"> (i) By January 2015 — approximately HK\$6.5 million (ii) By February 2015 — approximately HK\$4.9 million

FINANCIAL INFORMATION

(iii) By May and June 2015 — approximately HK\$2.9 million

(iv) By October 2015 — approximately HK\$3.8 million

Termination clause:

The Consultancy Service Agreement may be terminated at any time by the consultant or by TWIC by giving the other party thirty (30) business days' written notice, provided that TWIC may terminate the Consultancy Service Agreement forthwith for a cause without advance notice in situations such as the consultant was convicted of any criminal offence, his material breach of the contract, disregarding the instruction of TWIC and embezzlement of funds

Scope of services:

- (a) Formulation of our Group's five to ten years land development plans including (i) the setting up a tea processing plant, ice-cream production plant and food processing plant; (ii) facilitating the communication with the local authorities and advising our Group on the application procedures for setting up these plants and the obtain of the relevant licences; and (iii) advising our Group on the national regulations and regional government policies that may be applicable and beneficial to our Group. The fee for the formulation of land development plans for (i) the setting up the tea processing plant is approximately HK\$3.5 million, ice-cream production plant is approximately HK\$3.0 million, food processing plant is approximately HK\$3.7 million; and for (ii) and (iii) above is approximately HK\$2.8 million.

Economic benefits: In general, such plans target to enable our Group to expand its operation in the PRC and to capture the increasing demand of our products in the PRC. In particular, the intended establishment of the aforesaid plants may bring the following benefits to our Group: (i) tea processing plant: it will expand our tea processing capacity and could serve as a backup to our tea processing plant in Hong Kong; (ii) ice-cream production plant: the consultant would advise our Group on matters regarding the setting up of an ice-cream production plant on the Dongguan Land, such that we could relocate the then existing ice-cream production plant from Guangzhou to Dongguan. Together with other production plants located or planned to be located on the Dongguan Land, we could centralize and have better use of resources such as our manpower and management for operational efficiency; and (iii) food processing plant: it would enable us to expand our product offering to provide more comprehensive portfolio of products to our customers.

FINANCIAL INFORMATION

During the Track Record Period, the consultant has rendered his service by providing a proposal on the development plan of the Dongguan Land. Such proposal mainly included his advice that the construction of the tea processing plant, ice-cream production plant and food processing plant on the Dongguan Land is beneficial to our Group for its long-term development with reference to the potential growth of the catering industry in the PRC, the latest regional government policies that may encourage the future development of our operations in the PRC and deployment of each plant on the Dongguan Land for better utilization of the land. He has also advised on the application procedures for setting up the aforesaid plants and obtaining the relevant licences. In particular, the consultant has assisted our Group in communicating with local authorities for the setting up of the tea processing plant.

- (b) Change in land use rights of a partial of land within the Dongguan Land by providing guidance and assistance in relation to the relevant procedures for the change from collective-owned land to state-owned land. The fee for this is approximately HK\$5.0 million. For details, please refer to the sections headed “Business — Property — Owned Properties in Hong Kong and the PRC” and “Business — Legal Proceedings and Compliance — Non-compliance Matters” in this prospectus.

Economic benefits: Such change will accommodate our Group’s future development and expansion of our PRC operation for any transfer of, construction on, or mortgage of a state-owned land will not require the consent from at least two-thirds of village representatives or the members of a collective economic organisation for collective-owned land, so that our Group will have greater flexibility in its overall land use planning of the Dongguan Land in the long run.

During the Track Record Period, the consultant has advised our Group on the procedures involved in the change in land use rights, reviewed the application documents we completed and assisted in liaising with various local authorities in this regard.

Our Group completed the construction of the tea processing plant in Dongguan during the year ended December 31, 2015. We will continue to explore the feasibility of commencement of operation of food product processing plant after taking into account the latest market conditions and financial resources of our Group. However, given the lower than expected profitability of the ice-cream business after our acquisition of such business in June 2014 and our Group’s intention to focus on its beverage and food products business lines with better prospects, we disposed of our ice-cream business in May 2016 and our plan to construct an ice-cream production plant was thus aborted. For details for our disposal of the ice-cream business, please refer to the section headed “History, Development and Corporate Structure — History and Business Development — Material Development after Delisting — (b) Incorporation, Acquisitions and Disposal of Elect Gold” in this prospectus. Our Directors are of the view that the aforesaid business development plan is crucial to the long-term development of our Group.

FINANCIAL INFORMATION

The legal advisers to our Company as to Hong Kong laws are of the view that our Company does not violate any laws and regulations in Hong Kong regarding the consultancy service arrangement based on:

- (i) there are no laws and regulations in Hong Kong governing this type of consultancy arrangement;
- (ii) there are no laws and regulations in Hong Kong prohibiting any person to carry out the scope of works as set forth in the Consultancy Service Agreement; and
- (iii) the consultancy service is a commercial arrangement between the parties.

Our PRC Legal Advisers, having considered the relevant PRC laws and regulations (including the Contract Law of the PRC, the Civil Servant Law of the PRC and the Criminal Law of the PRC), and the confirmation made by the consultant and reasonable enquiry on his background and the activities performed pursuant to the agreement, are of the view that the Consultancy Service Agreement and the arrangements in relation thereto do not violate any laws and regulations in the PRC.

DESCRIPTION OF CERTAIN COMPONENTS OF CONSOLIDATED STATEMENTS OF PROFIT OR LOSS AND OTHER COMPREHENSIVE INCOME

The following paragraphs set out a brief discussion on the revenue, cost of sales, gross profit, gross profit margin, and other components of consolidated statements of profit or loss and other comprehensive income during the Track Record Period.

Revenue

During the Track Record Period, we derived our revenue from (i) providing beverage solutions, which primarily encompass offering total beverage solutions products to our customers, and (ii) selling food products, which include frozen meat and frozen processed food. We recognize revenue from the sale of food and beverages, when the significant risks and rewards of ownership have been transferred to our customers or distributors, provided that the Group maintains neither managerial involvement to the degree usually associated with ownership, nor effective control over the goods sold. For the years ended December 31, 2015, 2016 and 2017, our revenue was HK\$838.2 million, HK\$849.7 million and HK\$954.6 million, respectively.

FINANCIAL INFORMATION

The table below sets out a breakdown of our revenue categorized by business segment and by geographical location during the Track Record Period.

	Year ended December 31,					
	2015		2016		2017	
	(HK\$'000)	% of total	(HK\$'000)	% of total	(HK\$'000)	% of total
Beverage Solutions	634,723	75.7%	639,175	75.2%	711,349	74.5%
— Hong Kong	418,048	49.9%	422,548	49.7%	458,610	48.0%
— PRC	196,771	23.5%	199,822	23.5%	234,387	24.6%
— Macau	12,067	1.4%	11,387	1.3%	11,153	1.2%
— Others ⁽¹⁾	7,837	0.9%	5,418	0.7%	7,199	0.7%
Food Products	203,429	24.3%	210,545	24.8%	243,261	25.5%
— Hong Kong	194,670	23.2%	206,072	24.3%	238,743	25.0%
— PRC	8,759	1.1%	4,473	0.5%	4,518	0.5%
Total	838,152	100%	849,720	100%	954,610	100%

Note:

- Others mainly include sales to Australia, Canada, Malaysia, Philippines and Taiwan.

The following table sets out a breakdown of our revenue by product category:

	Year ended December 31,					
	2015		2016		2017	
	(HK\$'000)	% of total	(HK\$'000)	% of total	(HK\$'000)	% of total
Beverage Solutions	634,723	75.7%	639,175	75.2%	711,349	74.5%
— Coffee	194,654	23.2%	189,676	22.3%	198,033	20.7%
— Tea	188,738	22.5%	190,962	22.5%	228,676	24.0%
— Milk	80,082	9.6%	92,547	10.9%	97,009	10.2%
— Others						
— Groceries and others ⁽¹⁾	85,894	10.2%	81,338	9.6%	87,669	9.2%
— FMCG (i.e. All-In-One Beverage Products) and instant beverage mix ⁽²⁾	49,504	5.9%	48,339	5.7%	54,476	5.7%
— Monin products	24,826	3.0%	26,062	3.1%	28,418	3.0%
— Coffee and tea machines	11,025	1.3%	10,251	1.1%	17,068	1.7%
Food Products	203,429	24.3%	210,545	24.8%	243,261	25.5%
— Frozen meat	201,909	24.1%	202,211	23.8%	226,579	23.7%
— Frozen processed food	1,520	0.2%	8,334	1.0%	16,682	1.8%
Total	838,152	100%	849,720	100%	954,610	100%

FINANCIAL INFORMATION

Note:

1. Our groceries and others sales primarily include sales of Lipton yellow label tea.
2. Our retail sales equals to our FMCG sales, which amounted to approximately HK\$10.0 million, HK\$10.3 million and HK\$10.5 million for the years ended December 31, 2015, 2016 and 2017, respectively.

The following table sets out our average selling price and sales volume by product category:

	Year ended December 31,					
	2015		2016		2017	
	ASP (HK\$)	Vol. ('000)	ASP (HK\$)	Vol. ('000)	ASP (HK\$)	Vol. ('000)
Beverage Solutions						
— Coffee (lbs)	30.4	6,404	29.4	6,450	29.6	6,700
— Tea (lbs)	27.2	6,930	27.2	7,017	28.6	8,000
— Milk (cartons)	275.5	291	269.5	343	262.4	370
Food Products						
— Frozen meat (kg)	31.7	6,374	28.9	6,987	32.6	6,957
— Frozen processed food (kg)	73.6	21	65.0	128	63.9	261

The average selling price of our frozen meat products decreased in 2016 primarily because we sold a batch of lamb products we procured in prior year at lowered prices which led to a lowered average selling price, while the average selling price of our frozen meat products increased in 2017 mainly because of us selling more frozen meat from New Zealand and the United States which had higher average selling prices as demand for such products increased during the relevant period.

Beverage Solutions

A substantial portion of our revenue was generated from the beverage solutions segment. We have various types of coffee machines of which some of them are sold to customers, or leased to customers with a monthly rental charge and arrangements including those leased to customers with a separate pricing arrangement. Under such pricing arrangement, the purchase price of coffee beans and monthly rental charge of coffee machine are agreed between us and our customers. If customers' purchases of coffee beans reach the agreed minimum amount, the rental charge of coffee machine for that month will be free. Such arrangement starts on the 1st day of each month and clearance is made on a monthly basis or quarterly basis at the end of March, June, September and December. We have accounted for the income from the lease of coffee machines under such pricing arrangement within the revenue from the sales of goods as such pricing arrangement is a packaged sale arrangement as described above, and the related rental income is not material to our revenue. We have accounted for the cost of the lease of coffee machines under such pricing arrangement within cost of sales.

FINANCIAL INFORMATION

For the years ended December 31, 2015, 2016, and 2017, revenue from our beverage solutions segment represented 75.7%, 75.2% and 74.5% of our total revenue, respectively. Revenue from our beverage solutions business grew from HK\$634.7 million for the year ended December 31, 2015 to HK\$639.2 million for the year ended December 31, 2016, and further to HK\$711.3 million for the year ended December 31, 2017. The increase in revenue derived from our beverage solutions was primarily contributed by a growth in the volume of our coffee, tea and milk products, and to a lesser extent, the increase in the average selling price of our tea products. In terms of sales by geographical location, such increase was mainly a result of growth in sales of coffee and milk products in Hong Kong and tea products in the PRC. At the same time, the increase in our revenue derived from beverage solutions over the Track Record Period was also partially a result of our increase in sales of Monin products.

Food Products

Revenue from our food products segment represented 24.3%, 24.8% and 25.5% of our total revenue for the years ended December 31, 2015, 2016 and 2017, respectively. Revenue from our food products segment increased from HK\$203.4 million for the year ended December 31, 2015 to HK\$210.5 million for the year ended December 31, 2016 and further to HK\$243.3 million for the year ended December 31, 2017. The increase in our revenue from our food products segment mainly reflects variations to (i) the sales volume of our products, (ii) our expansion into the frozen processed food market, and (iii) growth in sales to existing customers.

Cost of sales

Our cost of sales represents the direct costs of operation, which primarily include material costs, packaging material costs, direct labor, overhead and depreciation.

For the years ended December 31, 2015, 2016, and 2017, our cost of sales was HK\$591.7 million, HK\$575.6 million and HK\$665.0 million, respectively, representing 70.6%, 67.7% and 69.7% of our total revenue, respectively for the same periods.

The fluctuation of our cost of sales as a percentage of our total revenue during the Track Record Period was primarily contributed by changes in raw material costs. Such changes mainly reflect market price fluctuations of our major raw materials including coffee beans, processed tea leaves and milk.

FINANCIAL INFORMATION

The following table sets forth the components of our cost of sales for the periods indicated:

	Year ended December 31,		
	2015	2016	2017
	<i>(HK\$'000)</i>	<i>(HK\$'000)</i>	<i>(HK\$'000)</i>
Material costs ⁽¹⁾	547,835	528,925	613,550
Packaging material costs	14,411	14,986	18,674
Direct labor	8,604	9,671	10,817
Overhead	6,335	6,594	8,011
Depreciation	<u>14,563</u>	<u>15,450</u>	<u>13,944</u>
Total	<u>591,748</u>	<u>575,626</u>	<u>664,996</u>

Note:

- Our material costs include purchases from our OEM contractors. Such purchases amounted to approximately HK\$61.7 million, HK\$67.7 million and HK\$50.4 million for the years ended December 31, 2015, 2016 and 2017, respectively.

The following table shows the cost of sales of each of our business segments and by geographical location for the periods indicated:

	Year ended December 31,					
	2015		2016		2017	
	<i>(HK\$'000)</i>	<i>% of total</i>	<i>(HK\$'000)</i>	<i>% of total</i>	<i>(HK\$'000)</i>	<i>% of total</i>
Beverage Solutions	397,110	67.1%	379,354	65.9%	447,015	67.2%
— Hong Kong	249,420	42.1%	243,044	42.2%	275,987	41.5%
— PRC	136,520	23.1%	126,553	22.0%	159,964	24.1%
— Macau	7,150	1.2%	7,078	1.2%	7,114	1.1%
— Others ⁽¹⁾	4,020	0.7%	2,679	0.5%	3,950	0.5%
Food Products	194,638	32.9%	196,272	34.1%	217,981	32.8%
— Hong Kong	185,638	31.4%	191,767	33.3%	214,402	32.2%
— PRC	<u>9,000</u>	<u>1.5%</u>	<u>4,505</u>	<u>0.8%</u>	<u>3,579</u>	<u>0.6%</u>
Total	<u>591,748</u>	<u>100%</u>	<u>575,626</u>	<u>100%</u>	<u>664,996</u>	<u>100%</u>

Note:

- Others mainly include sales to Australia, Canada, Malaysia, Philippines and Taiwan.

FINANCIAL INFORMATION

The following table shows a breakdown of our cost of sales by product category for the periods indicated:

	Year ended December 31,					
	2015		2016		2017	
	(HK\$'000)	% of total	(HK\$'000)	% of total	(HK\$'000)	% of total
Beverage Solutions	397,110	67.1%	379,354	65.9%	447,015	67.2%
— Coffee	106,687	18.0%	96,424	16.8%	110,445	16.6%
— Tea	96,090	16.2%	96,919	16.8%	129,137	19.4%
— Milk	67,774	11.5%	65,492	11.4%	72,927	11.0%
— Others						
— Groceries and others	69,303	11.7%	65,429	11.4%	69,434	10.3%
— FMCG (i.e. All-In-One beverage products) and instant beverage mix	33,164	5.6%	32,355	5.6%	35,631	5.4%
— Monin products	16,331	2.8%	16,464	2.8%	17,771	2.7%
— Coffee and tea machines	7,761	1.3%	6,271	1.1%	11,670	1.8%
Food Products	194,638	32.9%	196,272	34.1%	217,981	32.8%
— Frozen meat	193,412	32.7%	189,295	32.9%	205,455	30.9%
— Frozen processed food	1,226	0.2%	6,977	1.2%	12,526	1.9%
Total	591,748	100%	575,626	100%	664,996	100%

The following table shows the average procurement price for each of our major raw materials for the periods indicated:

	Year ended December 31,		
	2015	2016	2017
	HK\$	HK\$	HK\$
Beverage Solutions			
Coffee bean (per lb)	10.4	9.2	10.3
Processed tea leaves (per lb)	11.7	11.6	13.5
Milk (per carton)	218.9	190.7	199.7
Food Products			
Frozen meat (per kg)	23.9	26.4	28.9
Frozen processed food (per kg)	60.5	50.4	46.7

The average procurement price of our frozen meat products was relatively low in 2015 mainly because of the then strict import control in the PRC leading to an increase in supply of frozen meat products in Hong Kong, and accordingly a lower average procurement price. The average procurement price of our frozen meat products increased in 2016 and 2017 primarily because of change in frozen meat we procured, including more frozen meat from New Zealand and the United States, which commanded higher procurement prices.

FINANCIAL INFORMATION

Gross profit and gross profit margin

For the years ended December 31, 2015, 2016, and 2017, our gross profit was HK\$246.4 million, HK\$274.1 million and HK\$289.6 million, respectively, and our gross profit margin was 29.4%, 32.3% and 30.3%, respectively.

The following table shows the gross profit of each of our business segments and by geographical location for the periods indicated:

	Year ended December 31,					
	2015		2016		2017	
	(HK\$'000)	% of total	(HK\$'000)	% of total	(HK\$'000)	% of total
Beverage Solutions	237,613	96.4%	259,821	94.8%	264,334	91.3%
— Hong Kong	168,628	68.4%	179,504	65.5%	182,623	63.1%
— PRC	60,251	24.5%	73,269	26.7%	74,423	25.7%
— Macau	4,917	2.0%	4,309	1.6%	4,039	1.4%
— Others ⁽¹⁾	3,817	1.5%	2,739	1.0%	3,249	1.1%
Food Products	8,791	3.6%	14,273	5.2%	25,280	8.7%
— Hong Kong	9,032	3.7%	14,305	5.2%	24,341	8.4%
— PRC	(241)	-0.1%	(32)	—	939	0.3%
Total	246,404	100%	274,094	100%	289,614	100%

Note:

- Others mainly include sales to Australia, Canada, Malaysia, Philippines and Taiwan.

FINANCIAL INFORMATION

The following table shows the gross profit of each of our major products for the periods indicated:

	Year ended December 31,					
	2015		2016		2017	
	(HK\$'000)	% of total	(HK\$'000)	% of total	(HK\$'000)	% of total
Beverage Solutions	237,613	96.4%	259,821	94.8%	264,334	91.3%
— Coffee	87,967	35.7%	93,252	34.0%	87,588	30.2%
— Tea	92,648	37.6%	94,043	34.3%	99,539	34.4%
— Milk	12,308	5.0%	27,055	9.9%	24,082	8.3%
— Others						
— Groceries and others	16,591	6.8%	15,909	5.8%	18,235	6.3%
— FMCG (i.e. All-In-One beverage products) and instant beverage mix	16,340	6.6%	15,984	5.8%	18,845	6.5%
— Monin products	8,495	3.4%	9,598	3.5%	10,647	3.7%
— Coffee and tea machines	3,264	1.3%	3,980	1.5%	5,398	1.9%
Food Products	8,791	3.6%	14,273	5.2%	25,280	8.7%
— Frozen meat	8,497	3.5%	12,916	4.7%	21,124	7.3%
— Frozen processed food	294	0.1%	1,357	0.5%	4,156	1.4%
Total	<u>246,404</u>	<u>100%</u>	<u>274,094</u>	<u>100%</u>	<u>289,614</u>	<u>100%</u>

Our gross profit margin increased from 29.4% for the year ended December 31, 2015 to 32.3% for the year ended December 31, 2016 and decreased to 30.3% for the year ended December 31, 2017, primarily because of the change in market price of our primary raw materials, mainly coffee beans, processed tea leaves and milk. Our average procurement price of coffee beans decreased by 11.5% from HK\$10.4 per lb in 2015 to HK\$9.2 per lb in 2016, and increased by 12.0% to HK\$10.3 per lb in 2017. Our average procurement price of processed tea leaves decreased slightly from HK\$11.7 per lb in 2015 to HK\$11.6 per lb in 2016 and subsequently increased by 16.4% to HK\$13.5 per lb in 2017, while our average procurement price of milk decreased by 12.9% from HK\$218.9 per carton in 2015 to HK\$190.7 per carton in 2016, and increased by 4.7% to HK\$199.7 per carton in 2017.

FINANCIAL INFORMATION

The following table shows the gross profit margin of each of our business segments and by geographical location for the periods indicated:

	Year ended December 31,		
	2015	2016	2017
Beverage Solutions	37.4%	40.6%	37.2%
— Hong Kong	40.3%	42.5%	39.8%
— PRC	30.6%	36.7%	31.8%
— Macau	40.7%	37.8%	36.2%
— Others ⁽¹⁾	48.7%	50.6%	45.1%
Food Products	4.3%	6.8%	10.4%
— Hong Kong	4.6%	6.9%	10.2%
— PRC	<u>-2.8%</u>	<u>-0.7%</u>	<u>20.8%</u>
Total	<u>29.4%</u>	<u>32.3%</u>	<u>30.3%</u>

Note:

- Others mainly include sales to Australia, Canada, Malaysia, Philippines and Taiwan.

The following table shows the gross profit margin of each of our major products for the period indicated:

	Year ended December 31,		
	2015	2016	2017
Beverage Solutions	37.4%	40.6%	37.2%
— Coffee	45.2%	49.2%	44.2%
— Tea	49.1%	49.2%	43.5%
— Milk	15.4%	29.2%	24.8%
— Others			
— Groceries and others	19.3%	19.6%	20.8%
— FMCG (i.e. All-In-One beverage products) and instant beverage mix	33.0%	33.1%	34.6%
— Monin products	34.2%	36.8%	37.5%
— Coffee and tea machines	29.6%	38.8%	31.6%
Food Products	4.3%	6.8%	10.4%
— Frozen meat	4.2%	6.4%	9.3%
— Frozen processed food	<u>19.3%</u>	<u>16.3%</u>	<u>24.9%</u>
Total	<u>29.4%</u>	<u>32.3%</u>	<u>30.3%</u>

FINANCIAL INFORMATION

Beverage Solutions

The gross profit margin for our beverage solutions business increased from 37.4% for the year ended December 31, 2015 to 40.6% for the year ended December 31, 2016 primarily because of changes in raw material costs for coffee beans and milk. Our average procurement price of coffee beans decreased by 11.5% from HK\$10.4 per lb in 2015 to HK\$9.2 per lb in 2016 while our average selling price for coffee products recorded a decrease by 3.3% from HK\$30.4 per lb in 2015 to HK\$29.4 per lb in 2016, and our average procurement price of milk decreased by 12.9% from HK\$218.9 per carton in 2015 to HK\$190.7 per carton in 2016 while our average selling price for milk products recorded a decrease by 2.2% from HK\$275.5 per carton in 2015 to HK\$269.5 per carton in 2016. The aforementioned decrease in raw material costs for coffee beans and milk led to the increase in gross profit margin for our coffee and milk products in 2016.

The gross profit margin decreased to 37.2% for the year ended December 31, 2017 as compared to 40.6% for the year ended December 31, 2016 primarily due to increase in the average procurement price of processed tea leaves by 16.4% from HK\$11.6 per lb for the year ended December 31, 2016 to HK\$13.5 per lb for the year ended December 31, 2017 and increase in the average procurement price of coffee beans by 12.0% from HK\$9.2 per lb in 2016 to HK\$10.3 per lb in 2017.

Food Products

The gross profit margin for our food products business increased from 4.3% for the year ended December 31, 2015 to 6.8% for the year ended December 31, 2016 and further to 10.4% for the year ended December 31, 2017. The increase in the gross profit margin of our food products segment during the Track Record Period mainly reflected (i) changes in sales volume of our food products, (ii) changes in the prices of frozen meat products we sold, and (iii) our introduction of frozen processed food business in Hong Kong in 2015 and in the PRC in 2016 which yielded a relatively higher gross profit margin as compared to our frozen meat products.

Other income and gains, net

Our other income and gains, net, consists primarily of compensation we received from a supplier in relation to raw material supplied that did not meet our quality standards, compensation we received from a settled trademark litigation, interest income earned from the ultimate holding company, foreign exchange differences and gain on disposal of items of property, plant and equipment.

Our other income and gains, net, amounted to HK\$17.3 million for 2015 and HK\$17.1 million for 2016, primarily reflecting a one-time compensation we received from a milk supplier due to product quality issues in 2015 and compensation we received from a settled litigation relating to our trademark in 2015 and 2016. For further details, please refer to the sections headed “Business — Legal Proceedings and Compliance” in this prospectus. Receiving compensation from a milk supplier and the compensation from the settled trademark litigation are both non-recurring events. We do not expect to receive further compensation from such supplier or litigation after 2016.

FINANCIAL INFORMATION

Our other income and gains, net, decreased from HK\$17.1 million for the year ended December 31, 2016 to HK\$4.0 million for the year ended December 31, 2017. The change was primarily due to our receipt of the compensation in relation to a settled litigation relating to our trademark in 2016, which was non-recurring.

The components of our other income and gains, net, during the Track Record Period are summarized below:

	Year ended December 31,		
	2015	2016	2017
	<i>(HK\$'000)</i>	<i>(HK\$'000)</i>	<i>(HK\$'000)</i>
Other income, net			
Bank interest income	129	57	60
Interest income earned from the ultimate holding company	—	489	419
Interest income from financial investment at fair value through profit or loss	61	44	5
Dividend income from an available-for-sale investment	385	519	—
Compensation received from a supplier	3,256	—	—
Compensation from settled litigation	9,958	16,000	—
Others	222	(48)	751
	<u>14,011</u>	<u>17,061</u>	<u>1,235</u>
Gains, net			
Gains on disposal of items of property, plant and equipment, net	1,358	—	1,853
Reversal of impairment of an amount due from an associate	43	—	—
Foreign exchange differences, net	1,865	—	910
	<u>3,266</u>	<u>—</u>	<u>2,763</u>
Total	<u><u>17,277</u></u>	<u><u>17,061</u></u>	<u><u>3,998</u></u>

FINANCIAL INFORMATION

Selling and distribution expenses

Our selling and distribution expenses mainly consist of staff costs, marketing and promotion expenses, rent, rate, storage and building management fee we paid for our sales premises, and logistics expenses. Our selling and distribution expenses generally increased from HK\$97.5 million for 2015 to HK\$112.2 million for 2017 primarily due to (i) increase in average salaries for our staff and commission paid to our sales and marketing team, which was mainly a result of an increase in revenue as our beverage solutions business expanded, (ii) increase in rent, rate, storage and building management fee as we renewed our rent for premises for sales and marketing personnel and warehouses, and (iii) increase in logistics expense as we engaged third party service providers in connection with our business expansion.

For the years ended December 31, 2015, 2016, and 2017, our selling and distribution expenses as a percentage of our total revenue remained relatively stable being 11.6%, 12.8% and 11.8%, respectively. The components of our selling and distribution expenses during the Track Record Period are summarized below:

	Year ended December 31,		
	2015	2016	2017
	<i>(HK\$'000)</i>	<i>(HK\$'000)</i>	<i>(HK\$'000)</i>
Staff costs	53,598	59,059	59,363
Marketing and promotion	14,668	17,131	18,253
Rent, rate, storage and building management fee	11,292	12,468	13,401
Logistics expenses	7,636	9,432	12,262
Depreciation	4,185	3,734	2,847
Travelling and entertainment	2,377	2,657	2,248
Others	<u>3,724</u>	<u>4,409</u>	<u>3,871</u>
Total	<u>97,480</u>	<u>108,890</u>	<u>112,245</u>

Administrative expenses

Our administrative expenses primarily consist of staff costs, consultancy and professional fee, rent, rate and building management fee and depreciation and amortization expenses. Our administrative expenses decreased from HK\$89.9 million for 2015 to HK\$86.8 million for 2016 primarily due to decrease in (i) consultancy and professional fee, which was in line with the progress of our trademark litigation, and (ii) rent, rate and building management fee as we changed the usage and classification of one premise from office to warehouse which resulted in the rental cost being allocated from administrative expenses to selling and distribution expenses. The aforementioned decrease was partially offset by an increase in staff costs as we raised the salary of our employees. Our administrative expenses increased from HK\$86.8 million for the year ended December 31, 2016 to HK\$109.7 million for the year ended December 31, 2017 primarily due to a growth in our consultancy and professional fee incurred in relation to our Global Offering.

FINANCIAL INFORMATION

For the years ended December 31, 2015, 2016, and 2017, our administrative expenses as a percentage of our total revenue was 10.7%, 10.2% and 11.5%, respectively. The components of our administrative expenses during the Track Record Period are summarized as below:

	Year ended December 31,		
	2015 (HK\$'000)	2016 (HK\$'000)	2017 (HK\$'000)
Staff costs	49,966	50,623	53,046
Consultancy and professional fee	16,723	14,524	35,886
Rent, rate and building management fee	3,021	2,354	2,282
Depreciation and amortization	8,370	8,343	8,017
Utilities and office supplies	4,913	4,717	4,788
Travelling and entertainment	2,613	1,906	1,931
Others	<u>4,290</u>	<u>4,307</u>	<u>3,793</u>
Total	<u>89,896</u>	<u>86,774</u>	<u>109,743</u>

Other expenses, net

Our other expenses mainly consist of (i) expenses we incurred while discontinuing our sales of prune to an entity in the PRC in 2015. Such sales of prune constituted a *de minimis* portion of our revenue and gross profit during each of the respective periods during the Track Record Period, (ii) inventory write-down in value for our food products in 2015 as the prices for such products were adjusted downwards and we improved our inventory management over such products, (iii) inventory write-down in value for our coffee pod machines in 2015 as we ceased to sell such machines to our customers, and instead provided such machines to customers of our coffee products free of charge as part of our marketing effort, and (iv) impairment loss and write-down of inventories in phasing out the current model of milk tea machines in 2016. Our other expenses, net, were HK\$12.0 million, HK\$9.8 million and HK\$3.3 million for the years ended December 31, 2015, 2016 and 2017, respectively.

Finance costs

Our finance costs mainly consist of interest on bank borrowings. Our finance costs generally decreased from HK\$4.9 million for 2015 to HK\$4.0 million for 2016 primarily due to a reduction in the outstanding balance of our interest-bearing bank borrowings. Our finance costs increased slightly from HK\$4.0 million for 2016 to HK\$4.1 million for 2017 primarily due to increase in outstanding balance of our interest-bearing bank borrowings, which was partially offset by restructuring of a bank borrowing with lower interest rate.

FINANCIAL INFORMATION

Income tax expense

Our income tax expense primarily consists of current income tax at statutory rates applicable to our assessable profit before taxation as determined under the relevant laws and regulations and deferred tax arising from the movement in deferred tax assets or liabilities recognized for the reporting periods. For the years ended December 31, 2015, 2016 and 2017, our income tax expense for the continuing operations was HK\$12.8 million, HK\$17.4 million and HK\$15.8 million, respectively, and our effective tax rate was 21.6%, 21.3% and 24.6%, respectively.

We were not subject to any income tax in the Bermuda during the Track Record Period. Our Hong Kong subsidiaries were subject to income tax at the rate of 16.5% on the estimated assessable profits arising in Hong Kong during the Track Record Period. Provision for PRC enterprise income tax is calculated based on the statutory income tax rate of 25% on the assessable income of our respective PRC entities in accordance with relevant PRC enterprise income tax laws and regulations during the Track Record Period.

Discontinued operation

On May 31, 2016, we disposed of our equity interest in Elect Gold. Elect Gold Group is principally engaged in manufacture and wholesale of ice-cream and the operation of retail shops. Following the completion of the transaction, we discontinued our operations in ice cream business. The disposal of Elect Gold Group is part of our strategic plan to focus our resources on our beverage solutions and food products businesses. For further details, please refer to the section headed “History, Development and Corporate Structure — Material Development after Delisting — (b) Incorporation, Acquisitions and Disposal of Elect Gold” in this prospectus. Please see Note 11 of the Accountants’ Report as set out in Appendix I to this prospectus for further details regarding the financial information of Elect Gold Group.

Other comprehensive (loss)/income

Other comprehensive (loss)/income primarily represented exchange differences arising from translation of the financial statements of our operations registered in the PRC. We recorded losses of HK\$8.9 million and HK\$9.9 million for the years ended December 31, 2015 and 2016, respectively, from the translation of such operations due to the depreciation of both the weighted average exchange rate of RMB/HK\$ during the periods and at the end of the reporting periods, and income of HK\$11.5 million for the year ended December 31, 2017 arising from the strengthening of RMB.

FINANCIAL INFORMATION

PERIOD TO PERIOD COMPARISON OF RESULTS OF OPERATIONS**Comparison between the year ended December 31, 2017 and the year ended December 31, 2016***Revenue*

Our revenue increased by HK\$104.9 million, or 12.3%, from HK\$849.7 million for the year ended December 31, 2016 to HK\$954.6 million for the year ended December 31, 2017. The increase was primarily due to the increase in revenue derived from our beverage solutions business, and to a lesser extent, the growth in revenue derived from our food products business.

Beverage Solutions

The revenue from our beverage solutions segment increased from HK\$639.2 million for the year ended December 31, 2016 to HK\$711.3 million for the year ended December 31, 2017. Our revenue grew primarily because of the increase in revenue derived from our tea products, and to a lesser extent, the growth in sales of our coffee and milk products. In turn, such increase was mainly a result of an increase in sales volume of these products, which included increase in sales to new customers.

Food Products

The revenue from our food products segment increased from HK\$210.5 million for the year ended December 31, 2016 to HK\$243.3 million for the year ended December 31, 2017. Our revenue grew primarily because of the increase in (i) demand of frozen meat from the United States and New Zealand, which we believe was a result of the Brazilian frozen meat incident in the first half of 2017, and (ii) the sales volume of our frozen processed food, as we expanded such business and introduced such products to our beverage solutions customers.

Cost of sales

Our cost of sales increased by HK\$89.4 million, or 15.5%, from HK\$575.6 million for the year ended December 31, 2016 to HK\$665.0 million for the year ended December 31, 2017. The increase in our cost of sales was primarily a result of the increase in raw material costs for our beverage solutions products, which in turn was mainly a result of the growth in our overall sales volume and procurement price for our major raw materials.

Beverage Solutions

The cost of sales from our beverage solutions segment increased from HK\$379.4 million for the year ended December 31, 2016 to HK\$447.0 million for the year ended December 31, 2017. Our cost of sales grew primarily because of the increase in overall sales volume of our coffee, tea and milk products, and also an increment in the procurement price for coffee beans, processed tea leaves and milk. Our average procurement price of coffee beans increased by 12.0% from HK\$9.2 per lb for the year ended December 31, 2016 to

FINANCIAL INFORMATION

HK\$10.3 per lb for the year ended December 31, 2017, while our average procurement price of processed tea leaves increased by 16.4% from HK\$11.6 per lb for the year ended December 31, 2016 to HK\$13.5 per lb for the year ended December 31, 2017.

Food Products

The cost of sales from our food products segment increased from HK\$196.3 million for the year ended December 31, 2016 to HK\$218.0 million for the year ended December 31, 2017.

Gross profit and gross profit margin

As a result of the foregoing, our gross profit increased by HK\$15.5 million, or 5.7%, from HK\$274.1 million for the year ended December 31, 2016 to HK\$289.6 million for the year ended December 31, 2017. Our gross profit margin decreased from 32.3% for the year ended December 31, 2016 to 30.3% for the year ended December 31, 2017.

Beverage Solutions

The gross profit from our beverage solutions segment increased from HK\$259.8 million for the year ended December 31, 2016 to HK\$264.3 million for the year ended December 31, 2017. Our gross profit margin was 40.6% and 37.2% for the respective periods. Our gross profit margin decreased primarily because of the increase in raw material costs for our beverage solutions products, which in turn was mainly a result of a growth in the average procurement price for coffee beans, processed tea leaves and milk as disclosed above.

Food Products

The gross profit from our food products segment increased from HK\$14.3 million for the year ended December 31, 2016 to HK\$25.3 million for the year ended December 31, 2017. Our gross profit margin was 6.8% and 10.4% for the respective periods. Our gross profit grew primarily because of (i) increase in demand of frozen meat from the United States and New Zealand which we believe was partially contributed by the Brazilian meat incident in the first half of 2017 that led to better gross profit and gross profit margin for sales of frozen meat from the United States and New Zealand as there was an increase in demand for such products that resulted in an increase in the average selling price of such products accordingly, and (ii) an improvement in the gross profit margin of our frozen processed food products as a result of change in product mix.

Other income and gains, net

Our other income and gains, net, decreased by HK\$13.1 million from HK\$17.1 million for the year ended December 31, 2016 to HK\$4.0 million for the year ended December 31, 2017. The decrease was primarily a result of our receipt of a one-time compensation of HK\$16.0 million in relation to a settled litigation relating to our trademark in 2016, which was non-recurring.

FINANCIAL INFORMATION

Selling and distribution expenses

Our selling and distribution expenses increased by HK\$3.4 million, or 3.1%, from HK\$108.9 million for the year ended December 31, 2016 to HK\$112.2 million for the year ended December 31, 2017, primarily due to increase in (i) marketing and promotion expenses, (ii) storage expenses, and (iii) logistics expenses, which were generally in line with the increment in revenue.

Administrative expenses

Administrative expenses increased by HK\$23.0 million, or 26.5%, from HK\$86.8 million for the year ended December 31, 2016 to HK\$109.7 million for the year ended December 31, 2017. The increase was primarily a result of increase in consultancy and professional fee, which was incurred in relation to our Global Offering.

Other expenses, net

Other expenses, net, decreased by HK\$6.5 million, or 66.2%, from HK\$9.8 million for the year ended December 31, 2016 to HK\$3.3 million for the year ended December 31, 2017. The decrease was primarily a result of impairment loss and write-down of inventories in phasing out the current model of milk tea machine in 2016.

Finance costs

Our finance costs increased by HK\$0.1 million, or 3.0%, from HK\$4.0 million for the year ended December 31, 2016 to HK\$4.1 million for the year ended December 31, 2017. The increase was primarily as a result of increase in the outstanding balance of our interest-bearing bank borrowings, which was partially offset by restructuring of a bank borrowing with lower interest rate.

Income tax expense

Our income tax expense for the continuing operations decreased by HK\$1.6 million, or 9.2%, from HK\$17.4 million for the year ended December 31, 2016 to HK\$15.8 million for the year ended December 31, 2017. Our effective income tax rate for the continuing operations was 21.3% for the year ended December 31, 2016 and 24.6% for the year ended December 31, 2017.

Profit from a discontinued operation

We did not have profit from a discontinued operation for the year ended December 31, 2017 as we completed the disposal of our ice-cream operation in 2016.

FINANCIAL INFORMATION

Profit for the year and net profit margin

As a result of the foregoing, our profit for the year ended December 31, 2017 decreased by HK\$17.3 million, or 26.4%, from HK\$65.7 million for the year ended December 31, 2016 to HK\$48.4 million for the year ended December 31, 2017. Our net profit margin decreased from 7.7% for the year ended December 31, 2016 to 5.1% for the year ended December 31, 2017.

Comparison between the year ended December 31, 2016 and the year ended December 31, 2015***Revenue***

Our revenue increased by HK\$11.5 million, or 1.4%, from HK\$838.2 million for the year ended December 31, 2015 to HK\$849.7 million for the year ended December 31, 2016. The increase was primarily due to a growth in sales from each of our beverage solutions segment and food products segment.

Beverage Solutions

The revenue from our beverage solutions segment increased from HK\$634.7 million for the year ended December 31, 2015 to HK\$639.2 million for the year ended December 31, 2016. The increase was primarily because of an increase in the sales of our milk and tea products. In turn, such increase was mainly a result of a growth in (i) sales volume of milk products in Hong Kong and the PRC mainly due to the promotion and advertising activities which we conducted in 2016, partially offset by the decrease in the average selling price of milk products, and (ii) sales volume of tea products in the PRC as demand from our key customers in the PRC increased.

Food Products

The revenue from our food products segment increased from HK\$203.4 million for the year ended December 31, 2015 to HK\$210.5 million for the year ended December 31, 2016. The increase was primarily because of an increase in our sales of frozen processed food contributed by a material growth in the sales volume of our frozen processed food products in Hong Kong and the PRC as the year of 2016 was the first full year of our sales of such products.

Cost of sales

Our cost of sales decreased by HK\$16.1 million, or 2.7%, from HK\$591.7 million for the year ended December 31, 2015 to HK\$575.6 million for the year ended December 31, 2016. The reduction in our cost of sales was primarily a result of an industry-wide decrease in procurement price for our major raw materials including coffee bean and milk.

FINANCIAL INFORMATION

Beverage Solutions

The cost of sales for our beverage solutions segment decreased from HK\$397.1 million for the year ended December 31, 2015 to HK\$379.4 million for the year ended December 31, 2016. Such decrease was mainly attributable an industry-wide decrease in the average procurement price of coffee bean and milk. Our average procurement price of coffee bean decreased by 11.5% from HK\$10.4 per lb in 2015 to HK\$9.2 per lb in 2016, while our average procurement price of milk decreased by 12.9% from HK\$218.9 per carton in 2015 to HK\$190.7 per carton in 2016.

Food Products

The cost of sales for our food products segment increased from HK\$194.6 million for the year ended December 31, 2015 to HK\$196.3 million for the year ended December 31, 2016. The cost of sales of our food products segment grew primarily because of the increase in the sales volume of our frozen meat in Hong Kong and our frozen processed food in both Hong Kong and the PRC.

Gross profit and gross profit margin

As a result of the foregoing, our gross profit increased by HK\$27.7 million, or 11.2%, from HK\$246.4 million for the year ended December 31, 2015 to HK\$274.1 million for the year ended December 31, 2016. Our gross profit margin increased from 29.4% for the year ended December 31, 2015 to 32.3% for the year ended December 31, 2016.

Beverage Solutions

The gross profit for our beverage solutions segment increased from HK\$237.6 million for the year ended December 31, 2015 to HK\$259.8 million for the year ended December 31, 2016, while the gross profit margin for the corresponding periods was 37.4% and 40.6%, respectively. The increase in gross profit for our beverage solutions segment was primarily attributable to a growth in the gross profit for our milk and coffee products in both Hong Kong and the PRC and tea products in the PRC. The increase in gross profit margin was primarily a result of an increase in our coffee and milk products' gross profit margin, which in turn was mainly due to the decrease in our average procurement price of coffee bean and milk during the year as discussed above.

Food Products

The gross profit for our food products segment increased from HK\$8.8 million for the year ended December 31, 2015 to HK\$14.3 million for the year ended December 31, 2016, while the gross profit margin for the corresponding periods was 4.3% and 6.8%, respectively. The gross profit for our food products segment increased primarily as a result of an increase in sales volume of frozen meat in Hong Kong. The increase in gross profit margin for our food products segment was contributed by the increase in sales of frozen processed food products in Hong Kong, which generally had a relatively high gross profit margin.

FINANCIAL INFORMATION

Other income and gains, net

Our other income and gains, net, decreased by HK\$0.2 million from HK\$17.3 million for the year ended December 31, 2015 to HK\$17.1 million for the year ended December 31, 2016. The decrease was primarily a result of decrease in one-time compensation received from a milk supplier, gains on disposal of property, plant and equipment and foreign exchange differences, offset by us receiving a one-time compensation of HK\$16.0 million relating to a settled trademark litigation in 2016. For further details, please refer to the section headed “Business — Legal Proceedings and Compliance” in this prospectus.

Selling and distribution expenses

Our selling and distribution expenses increased by HK\$11.4 million, or 11.7%, from HK\$97.5 million for the year ended December 31, 2015 to HK\$108.9 million for the year ended December 31, 2016. The increase was primarily due to a growth in (i) staff costs, which reflected an increase in commission paid to our staff in connection with better work performance and an increase in average salary of our employees, and to a lesser extent, an increase in our headcount, (ii) rent, rate, storage and building management fee as a result of increase in rental costs as we renewed leases for various premises for sales and marketing personnel and warehouses and changed the usage and classification of one premise from office to warehouse which resulted in the rental cost being allocated from administrative expenses to selling and distribution expenses, (iii) marketing and promotion expenses, which included costs we incurred in relation to our enhanced promotion of milk products in 2016, and (iv) logistics expenses as we engaged more third party logistics services providers to support our logistical needs.

Administrative expenses

Administrative expenses decreased by HK\$3.1 million, or 3.5%, from HK\$89.9 million for the year ended December 31, 2015 to HK\$86.8 million for the year ended December 31, 2016. The decrease was primarily a result of a decrease in (i) consultancy and professional fee, which was in line with the progress of our trademark litigation, and (ii) our rent, rate and building management fee as we changed the usage and classification of one premise from office to warehouse which resulted in the rental cost being allocated from administrative expenses to selling and distribution expenses. Such decrease was partially offset by an increase in staff costs, which was in turn mainly a result of an increase in our average salary of our employees.

Other expenses, net

Other expenses, net, decreased by HK\$2.2 million, or 18.0%, from HK\$12.0 million for the year ended December 31, 2015 to HK\$9.8 million for the year ended December 31, 2016. The decrease was primarily a result of the one-time write-down in value for our frozen meat products and coffee pod machines inventories in 2015.

FINANCIAL INFORMATION

Finance costs

Our finance costs decreased by HK\$0.9 million, or 17.8%, from HK\$4.9 million for the year ended December 31, 2015 to HK\$4.0 million for the year ended December 31, 2016. The decrease was primarily a result of a reduction in the outstanding balance of our interest-bearing bank borrowings.

Income tax expense

Our income tax expense for the continuing operations increased by HK\$4.6 million, or 35.5%, from HK\$12.8 million for the year ended December 31, 2015 to HK\$17.4 million for the year ended December 31, 2016, mainly due to the increase in profit before tax from continuing operations. Our effective income tax rate for the continuing operations decreased from 21.6% for the year ended December 31, 2015 to 21.3% for the year ended December 31, 2016.

Loss/profit from a discontinued operation

Our profit from a discontinued operation for the year ended December 31, 2016 was HK\$1.5 million as compared to a loss of HK\$7.1 million for the year ended December 31, 2015. The change was primarily a result of (i) the one-time goodwill impairment of HK\$4.9 million on our ice-cream business in 2015, and (ii) the gain on disposal of our ice-cream operation in May 2016.

Profit for the year and net profit margin

As a result of the foregoing, our profit increased significantly by HK\$26.2 million, or 66.5%, from HK\$39.5 million for the year ended December 31, 2015 to HK\$65.7 million for the year ended December 31, 2016. Our net profit margin increased from 4.7% for the year ended December 31, 2015 to 7.7% for the year ended December 31, 2016.

LIQUIDITY, FINANCIAL RESOURCES AND CAPITAL STRUCTURES

Our primary uses of cash are payment for raw materials, operational expenses and expansion related expenses. To date, we have funded our operations principally with cash from operating activities, bank credit facilities and equity financings from investors. In the future, we believe that our liquidity requirements will be satisfied with a combination of cash flows generated from operating activities, bank credit facilities, together with cash received from this Global Offering and other funds raised from the capital markets from time to time.

FINANCIAL INFORMATION

Cash Flow

As of December 31, 2015, 2016 and 2017, we had cash and cash equivalents of approximately HK\$59.9 million, HK\$48.1 million and HK\$45.6 million, respectively. The following table sets forth our cash flows for the periods indicated:

	Year ended December 31,		
	2015	2016	2017
	<i>(HK\$'000)</i>	<i>(HK\$'000)</i>	<i>(HK\$'000)</i>
Net cash flows generated from operating activities	82,693	118,694	26,768
Net cash flows used in investing activities	(19,952)	(111,971)	(26,572)
Net cash flows used in financing activities	<u>(88,168)</u>	<u>(17,663)</u>	<u>(3,689)</u>
Net decrease in cash and cash equivalents	(25,427)	(10,940)	(3,493)
Cash and cash equivalents at beginning of year	86,864	59,924	48,100
Effect of foreign exchange rate changes, net	<u>(1,513)</u>	<u>(884)</u>	<u>1,006</u>
Cash and cash equivalents at end of year	<u>59,924</u>	<u>48,100</u>	<u>45,613</u>

Cash flows from operating activities

Our net cash generated from operating activities was HK\$26.8 million for the year ended December 31, 2017. This net inflow was primarily a result of profit before tax of HK\$64.2 million and positive non-cash item adjustments mainly for depreciation of HK\$22.4 million, write-down of inventories to net realisable value of HK\$1.3 million and impairment of trade receivables of HK\$1.2 million, reduced by changes in working capital of HK\$47.8 million and income tax paid of HK\$19.7 million. Changes in working capital primarily comprised an increase in inventories of HK\$45.3 million, an increase in trade receivables of HK\$39.1 million, an increase in trade and bills payables of HK\$19.3 million, which were generally in line with growth in sale of our business, and increase in accruals and other payables of HK\$14.9 million, mainly as a result of expenses we accrued in relation to the Global Offering.

Our net cash generated from operating activities was HK\$118.7 million for the year ended December 31, 2016. This net inflow was primarily a result of profit before tax from continuing operations of HK\$81.6 million, profit before tax from a discontinued operation of HK\$1.5 million and positive non-cash item adjustments mainly for depreciation of HK\$25.3 million, write-off of inventories of HK\$2.8 million and write-down of inventories to net realisable value of HK\$3.7 million, negative non-cash item adjustments mainly for gain on disposal of a discontinued operation of HK\$2.7 million, increased by changes in working capital of HK\$18.3 million and reduced by income tax paid of HK\$20.1 million. Changes in working capital primarily comprised a decrease in inventories of HK\$5.8

FINANCIAL INFORMATION

million, a decrease in trade and bills payables of HK\$2.5 million, a decrease in prepayments, deposits and other receivables of HK\$7.6 million and an increase in accruals and other payables of HK\$5.3 million.

Our net cash generated from operating activities was HK\$82.7 million for the year ended December 31, 2015. This net inflow was primarily a combined result of profit before tax from continuing operations of HK\$59.4 million, loss before tax from a discontinued operation of HK\$7.1 million and positive non-cash item adjustments mainly for depreciation of HK\$25.0 million, impairment of goodwill of HK\$4.9 million and write-down of inventories to net realisable value of HK\$8.4 million, reduced by changes in working capital of HK\$0.7 million and reduced by income tax paid of HK\$16.6 million. Changes in working capital comprised a decrease in inventories of HK\$41.2 million, an increase in trade receivables of HK\$20.9 million, an increase in prepayments, deposits and other receivables of HK\$15.1 million, a decrease in trade and bills payables of HK\$17.2 million and an increase in accruals and other payables of HK\$11.3 million.

Cash flows used in investing activities

For the year ended December 31, 2017, our net cash used in investing activities amounted to HK\$26.6 million, primarily attributable to advances to ultimate holding company of HK\$19.4 million, purchases of items of property, plant and equipment of HK\$15.4 million and payments for purchases of financial investments of HK\$6.9 million, which was partially offset by proceeds from redemption of financial investments of HK\$15.1 million.

For the year ended December 31, 2016, our net cash used in investing activities amounted to HK\$112.0 million, primarily attributable to payments for purchases of financial investments of HK\$47.8 million, advances to the ultimate holding company of HK\$45.1 million, loans to the ultimate holding company of HK\$42.8 million, and purchases of items of property, plant and equipment of HK\$23.6 million, which was partially offset by proceeds from redemption of financial investments of HK\$39.7 million and distribution received from an available-for-sale investment of HK\$7.8 million.

For the year ended December 31, 2015, our net cash used in investing activities amounted to HK\$20.0 million, primarily attributable to payments for purchases of financial investments of HK\$45.4 million and purchase of property, plant and equipment of HK\$22.5 million, which was partially offset by proceeds from redemption of financial investments of HK\$45.4 million.

FINANCIAL INFORMATION

Cash flows used in financing activities

For the year ended December 31, 2017, our net cash flow used in financing activities amounted to HK\$3.7 million, primarily attributable to repayment of bank borrowings of HK\$441.6 million and dividends paid of HK\$14.5 million, which was partially offset by new bank borrowings of HK\$458.7 million.

For the year ended December 31, 2016, our net cash flow used in financing activities amounted to HK\$17.7 million, primarily attributable to repayment of bank borrowings of HK\$450.3 million and dividends paid of HK\$13.0 million, which was partially offset by new bank borrowings of HK\$449.6 million.

For the year ended December 31, 2015, our net cash flow used in financing activities amounted to HK\$88.2 million, primarily attributable to repayment of bank borrowings of HK\$368.4 million and dividends paid of HK\$28.1 million, which was partially offset by new bank borrowings of HK\$313.3 million.

Working Capital

During the Track Record Period, we met our working capital needs mainly from our cash and cash equivalents on hand, cash flow generated from operating activities, bank borrowings and equity financing. We manage our cash flow and working capital by closely monitoring and managing our operations and expansion plans. We also review future cash flow requirements and adjust our operation and expansion plans, if necessary, to ensure that we maintain sufficient working capital to support our business operations and expansion plans. Based on the foregoing and taking into account the financial resources available to us, including our cash and cash equivalents on hand, available banking facilities, cash flow generated from operating activities and the estimated net proceeds from the Global Offering, our Directors are of the opinion that we have sufficient working capital required for our operations at present and for at least the next 12 months from the date of this prospectus.

FINANCIAL INFORMATION

DESCRIPTION OF CERTAIN COMPONENTS OF STATEMENTS OF FINANCIAL POSITION
Current Assets and Liabilities

The following table sets forth details of our current assets and liabilities as of the dates indicated:

	As of December 31,			As of
	2015	2016	2017	February 28,
	<i>(HK\$'000)</i>	<i>(HK\$'000)</i>	<i>(HK\$'000)</i>	<i>(HK\$'000)</i>
				(unaudited)
Current Assets				
Inventories	163,651	147,227	195,370	195,172
Trade receivables	135,164	128,923	170,353	162,786
Prepaid land lease payments	413	384	415	415
Prepayments, deposits and other receivables	24,257	21,957	19,885	23,967
Loans to the ultimate holding company	—	42,849	—	—
Due from the ultimate holding company	—	35,261	—	—
Due from related companies	—	7,214	—	—
Financial investment at fair value through profit or loss	—	7,781	—	—
Tax recoverable	158	217	2,352	821
Cash and cash equivalents	<u>59,924</u>	<u>48,100</u>	<u>45,613</u>	<u>74,811</u>
Total current assets	<u>383,567</u>	<u>439,913</u>	<u>433,988</u>	<u>457,972</u>
Current Liabilities				
Trade and bills payables	74,525	69,743	91,624	98,432
Accruals and other payables	39,835	42,078	59,187	57,931
Interest-bearing bank borrowings	115,490	130,630	138,800	149,577
Tax payable	<u>6,027</u>	<u>3,333</u>	<u>2,349</u>	<u>3,259</u>
Total current liabilities	<u>235,877</u>	<u>245,784</u>	<u>291,960</u>	<u>309,199</u>
Net Current Assets	<u><u>147,690</u></u>	<u><u>194,129</u></u>	<u><u>142,028</u></u>	<u><u>148,773</u></u>

FINANCIAL INFORMATION

We recorded net current assets of HK\$147.7 million, HK\$194.1 million and HK\$142.0 million as of December 31, 2015, 2016 and 2017, respectively. Our current assets consist primarily of inventories, trade receivables and cash and cash equivalents. The major components of our current liabilities include interest-bearing bank borrowings, trade and bills payables and accruals and other payables.

Comparison between as of February 28, 2018 and as of December 31, 2017

Our net current assets increased from HK\$142.0 million as of December 31, 2017 to HK\$148.8 million as of February 28, 2018, primarily because of (i) an increase of HK\$29.2 million in cash and cash equivalents and (ii) an increase of HK\$4.1 million in prepayments, deposits and other receivables for purchase of food products to meet sales demand for growth in scale of business, which was partially offset by (iii) an increase in interest-bearing bank borrowings of HK\$10.8 million drawn for working capital purposes, (iv) an increase of HK\$6.8 million in trade and bills payables from timing of settlement, and (v) a decrease of HK\$7.6 million in trade receivables from settlement.

Comparison between as of December 31, 2017 and as of December 31, 2016

Our net current assets decreased from HK\$194.1 million as of December 31, 2016 to HK\$142.0 million as of December 31, 2017, primarily because of (i) an increase of HK\$21.9 million in trade and bills payables as we increased purchase of inventories, which was in line with the growth in scale of our business, (ii) an increase of HK\$17.1 million in accruals and other payables primarily due to the expenses we accrued in relation to the Global Offering, (iii) an increase of HK\$8.2 million in interest-bearing bank borrowings for working capital purposes and (iv) a decrease of HK\$42.8 million in loans to the ultimate holding company, a decrease of HK\$35.3 million in amount due from the ultimate holding company and a decrease of HK\$7.2 million in amounts due from related companies from settlement. The aforementioned was partially offset by (i) an increase of HK\$48.1 million in inventories mainly due to (A) increase in tea inventory as we stored more raw materials for tea products in light of the forecasted price increase, (B) increase in raw materials for instant products to fulfill sales demand of a major customer, and (C) growth in stock of food products to diversify the product variety, and (ii) an increase of HK\$41.4 million in trade receivables mainly due to growth in scale of our business.

Comparison between as of December 31, 2016 and as of December 31, 2015

Our net current assets increased from HK\$147.7 million as of December 31, 2015 to HK\$194.1 million as of December 31, 2016, primarily because of (i) an increase of HK\$42.8 million in interest-bearing loans to the ultimate holding company and an increase of HK\$35.3 million in amount due from the ultimate holding company which was made interest-free and settled during the year ended December 31, 2017, (ii) an increase of HK\$7.8 million in financial investment at fair value through profit or loss, which relates to our investment in financial products in the PRC, (iii) an increase of HK\$7.2 million in amount due from related companies for the support of the operations of our previously

FINANCIAL INFORMATION

owned ice-cream business, and (iv) a decrease of HK\$4.8 million in trade and bills payables as we improved the payable cycles of our food products business and utilized more trust receipt loans to settle our payables in the PRC. The aforementioned was partially offset by (i) a decrease of HK\$16.4 million in inventories as a result of our enhanced management of food products storage, including measures such as more frequent checks on the inventory level, (ii) an increase of HK\$15.1 million in interest-bearing bank borrowings, (iii) a decrease of HK\$11.8 million in cash and cash equivalents, and (iv) a decrease of HK\$6.2 million in trade receivables as we enhanced the receivables management of our food products business through implementing measures to monitor our food products business and made appropriate adjustments accordingly.

Inventories

Our inventories consist of raw materials, work-in-progress and finished goods. The following table sets forth the breakdown of our inventories as of the dates indicated:

	As of December 31,		
	2015	2016	2017
	<i>(HK\$'000)</i>	<i>(HK\$'000)</i>	<i>(HK\$'000)</i>
Raw materials			
— Beverage solutions	46,987	50,277	79,024
— Food products	—	—	—
	<u>46,987</u>	<u>50,277</u>	<u>79,024</u>
Work-in-progress			
— Beverage solutions	149	292	749
— Food products	—	—	—
	<u>149</u>	<u>292</u>	<u>749</u>
Finished goods			
— Beverage solutions	51,841	50,040	53,619
— Food products	64,674	46,618	61,978
	<u>116,515</u>	<u>96,658</u>	<u>115,597</u>
Total	<u>163,651</u>	<u>147,227</u>	<u>195,370</u>

FINANCIAL INFORMATION

Our inventories decreased from HK\$163.7 million as of December 31, 2015 to HK\$147.2 million as of December 31, 2016 mainly as a result of enhanced inventory management at our food products subsidiary, Whole Sun. Our inventories increased to HK\$195.4 million as of December 31, 2017 primarily because of (i) increase in tea inventory as we stored more raw materials for tea products in light of the forecasted price increase, (ii) increase in raw materials for instant products to fulfil sales demand of a major customer, and (iii) growth in stock of food products to diversify the product variety.

As of the Latest Practicable Date, we utilized HK\$164.1 million, approximately 84.0% of our inventories as of December 31, 2017. In addition, our inventory balance of finished beverage goods consist of both finished goods produced by us and trading items we procured, including coffee machines. Finished goods produced by us as a percentage of the balance of finished beverage goods were generally less than 35% as of December 31, 2015, 2016 and 2017, respectively.

The following table sets forth our average inventory turnover days for the periods indicated:

	For the year ended December 31,		
	2015	2016	2017
Average inventory turnover days ⁽¹⁾	117	99	94

Note:

- (1) Average inventory turnover days equal to the average of the opening and closing balances of inventories of the relevant year divided by cost of sales of the relevant year and multiplied by 365 days for the year ended December 31, 2015 and 2017, and 366 days for the year ended December 31, 2016, respectively.

Our inventory turnover days decreased from 117 days for the year ended December 31, 2015 to 99 days for the year ended December 31, 2016 and further decreased to 94 days for the year ended December 31, 2017, primarily as a result of enhanced inventory management at our food products subsidiary, Whole Sun.

FINANCIAL INFORMATION

Trade receivables

We generally require our customers to pay within 30 to 120 days, except for new customers where we normally trade in cash on delivery. We maintain strict control over outstanding receivables and overdue balances are reviewed regularly by management. The following table sets forth a breakdown of our trade receivables as of the dates indicated:

	As of December 31,		
	2015	2016	2017
	<i>(HK\$'000)</i>	<i>(HK\$'000)</i>	<i>(HK\$'000)</i>
Trade receivables	138,512	131,877	174,571
Impairment	<u>(3,348)</u>	<u>(2,954)</u>	<u>(4,218)</u>
Total	<u>135,164</u>	<u>128,923</u>	<u>170,353</u>

As of December 31, 2015, 2016 and 2017, our trade receivables amounted to HK\$135.2 million, HK\$128.9 million and HK\$170.4 million, respectively. Our trade receivables as of December 31, 2016 decreased to HK\$128.9 million, primarily because of enhanced receivables management with respect to our food products segment. Our trade receivables as of December 31, 2017 increased to HK\$170.4 million, primarily because of growth in scale of our business.

As of the Latest Practicable Date, we received settlement of HK\$155.6 million, approximately 91.3% of the trade receivables outstanding as of December 31, 2017.

The following table sets forth the aging analysis of our trade receivables as of the dates indicated, based on the invoice date and net of provisions:

	As of December 31,		
	2015	2016	2017
	<i>(HK\$'000)</i>	<i>(HK\$'000)</i>	<i>(HK\$'000)</i>
Within 30 days	80,459	77,675	101,908
31 to 60 days	35,553	34,187	40,149
61 to 90 days	8,696	9,160	15,058
91 to 120 days	6,035	5,861	7,282
121 to 180 days	2,814	1,073	4,227
181 to 360 days	724	755	1,649
Over 360 days	<u>883</u>	<u>212</u>	<u>80</u>
	<u>135,164</u>	<u>128,923</u>	<u>170,353</u>

FINANCIAL INFORMATION

The aging analysis of the trade receivables that are not individually nor collectively considered to be impaired is as follows:

	As of December 31,		
	2015 <i>(HK\$'000)</i>	2016 <i>(HK\$'000)</i>	2017 <i>(HK\$'000)</i>
Neither past due nor impaired	111,774	108,946	145,529
Less than 30 days past due	<u>12,885</u>	<u>13,573</u>	<u>13,796</u>
	<u>124,659</u>	<u>122,519</u>	<u>159,325</u>

Trade receivables that were neither past due nor impaired relate to a large number of diversified customers for whom there was no recent history of default.

Trade receivables that were past due but not impaired relate to a number of customers that have a good track record with us. Based on past experience, our Directors are of the view that no provision for impairment is necessary in respect of these balances as there has not been a significant change in their credit quality and the balances are still considered fully recoverable.

The following table sets forth our trade receivables turnover days for the periods indicated:

	For the year ended December 31,		
	2015	2016	2017
Average trade receivables turnover days ⁽¹⁾	55	57	57

Note:

- (1) Average trade receivables turnover days equal to the average of the opening and closing balances of trade receivables of the relevant year divided by revenue of the relevant year and multiplied by 365 days for the year ended December 31, 2015 and 2017, and 366 days for the year ended December 31, 2016, respectively.

Our average trade receivables turnover days increased from 55 days for the year ended December 31, 2015 to 57 days for the year ended December 31, 2016, which was mainly due to (i) the large amount of trade receivable outstanding as of January 1, 2016 due to the payment schedule of a particular batch of products sold to one of our major customers, and (ii) the payment schedule for a batch of frozen meat sold by our subsidiary, Whole Sun. Our trade receivables turnover days remained stable at 57 days for the year ended December 31, 2017.

FINANCIAL INFORMATION

Prepayments, deposits and other receivables

The following table sets forth a breakdown of the prepayments, deposits and other receivables as of the dates indicated:

	As of December 31,		
	2015	2016	2017
	<i>(HK\$'000)</i>	<i>(HK\$'000)</i>	<i>(HK\$'000)</i>
Deposits	3,053	3,191	3,862
Prepayments	24,832	18,952	17,891
Other receivables	<u>5,995</u>	<u>3,120</u>	<u>1,748</u>
	33,880	25,263	23,501
Less: Non-current portion	<u>(9,623)</u>	<u>(3,306)</u>	<u>(3,616)</u>
Current portion	<u>24,257</u>	<u>21,957</u>	<u>19,885</u>

Our current portion of prepayments, deposits and other receivables decreased from HK\$24.3 million as of December 31, 2015 to HK\$22.0 million as of December 31, 2016 primarily because of amortization of consultancy fee for land use rights and development plan in Dongguan. Our current portion of prepayments, deposits and other receivables decreased to HK\$19.9 million as of December 31, 2017 primarily because of amortization of the said consultancy fee which was partially offset by a growth in prepayments for (a) marketing and promotion expenses and (b) Listing expenses in relation to the Global Offering.

Cash and cash equivalents

The following table sets forth the cash and bank balances as of the dates indicated:

	As of December 31,		
	2015	2016	2017
	<i>(HK\$'000)</i>	<i>(HK\$'000)</i>	<i>(HK\$'000)</i>
Cash and bank balances	<u>59,924</u>	<u>48,100</u>	<u>45,613</u>

The following table sets forth the cash and bank balances denominated in foreign currency as of the dates indicated:

	As of December 31,		
	2015	2016	2017
	<i>(HK\$'000)</i>	<i>(HK\$'000)</i>	<i>(HK\$'000)</i>
RMB	<u>20,337</u>	<u>13,097</u>	<u>13,660</u>

FINANCIAL INFORMATION

Our cash denominated in RMB is not freely convertible into other currencies. However, under Mainland China's Foreign Exchange Control Regulations and Administration of Settlement, Sale and Payment of Foreign Exchange Regulations, the Group is permitted to exchange RMB for other currencies through banks authorized to conduct foreign exchange business.

Our cash at banks earns interest at floating rates based on daily bank deposit rates. Our bank balances are deposited with creditworthy banks with no recent history of default.

Trade and bills payables

The following table sets forth a breakdown of our trade and bills payables as of the dates indicated:

	As of December 31,		
	2015	2016	2017
	<i>(HK\$'000)</i>	<i>(HK\$'000)</i>	<i>(HK\$'000)</i>
Trade payables	72,380	68,669	90,318
Bills payable	<u>2,145</u>	<u>1,074</u>	<u>1,306</u>
Total	<u>74,525</u>	<u>69,743</u>	<u>91,624</u>

Our trade and bills payables decreased from HK\$74.5 million as of December 31, 2015 to HK\$69.7 million as of December 31, 2016 mainly because of enhanced payables management of our food products business and enhanced inventory management by reducing inventory level of our food products. Our trade and bills payables increased to HK\$91.6 million as of December 31, 2017 primarily because of (i) our increased purchase of inventories, which was mainly as a result of growth in business, and (ii) increased purchase of food products to diversify the product variety.

As of the Latest Practicable Date, we settled HK\$89.3 million, approximately 97.4% of the trade and bills payables outstanding as of December 31, 2017.

Our trade payables are non-interest bearing and are normally settled within 30 to 60 days. The bills payable have a maturity period of 120 days.

FINANCIAL INFORMATION

The following table sets forth the aging analysis of our trade and bills payables, based on the invoice date, as of the dates indicated:

	As of December 31,		
	2015	2016	2017
	<i>(HK\$'000)</i>	<i>(HK\$'000)</i>	<i>(HK\$'000)</i>
Within 1 month	67,529	62,480	85,996
1 to 2 months	911	856	3,593
2 to 3 months	187	324	420
Over 3 months	<u>5,898</u>	<u>6,083</u>	<u>1,615</u>
	<u><u>74,525</u></u>	<u><u>69,743</u></u>	<u><u>91,624</u></u>

The following table sets forth our trade and bills payables turnover days for the periods indicated:

	Year ended December 31,		
	2015	2016	2017
Average turnover days of our trade and bills payables ⁽¹⁾	52	46	44

Note:

- (1) Average turnover days of our trade and bills payables equal to the average of the trade and bills payables at the beginning and the end of the relevant year divided by cost of sales of the relevant year and multiplied by 365 days for the year ended December 31, 2015 and 2017, and 366 days for the year ended December 31, 2016, respectively.

Our average turnover days of our trade and bills payables decreased from 52 days for the year ended December 31, 2015 to 46 days for the year ended December 31, 2016 mainly because of enhanced trade and bills payables management of our food products business. Our average turnover days of our trade and bills payables remained relatively stable at 44 days for the year ended December 31, 2017.

FINANCIAL INFORMATION

Accruals and other payables

The following table sets forth the breakdown of accruals and other payables as of the dates indicated:

	As of December 31,		
	2015	2016	2017
	<i>(HK\$'000)</i>	<i>(HK\$'000)</i>	<i>(HK\$'000)</i>
Accruals			
— Provision for audit fee	1,441	1,189	1,312
— Provision for bonus	6,994	8,722	9,169
— Provision for sales rebate	7,793	10,505	11,452
— Accrued expenses	11,188	10,135	24,275
— Accrued staff costs	<u>2,040</u>	<u>2,215</u>	<u>3,179</u>
	29,456	32,766	49,387
Receipts in advance	4,018	2,631	2,676
Other payables	<u>6,361</u>	<u>6,681</u>	<u>7,124</u>
Total	<u>39,835</u>	<u>42,078</u>	<u>59,187</u>

Our accruals and other payables primarily consist of accrued expenses mainly relating to professional fee and legal fee, bonus accrued that are to be paid to our staff and sales rebate to our customers as a result of meeting sales targets. Our accruals and other payables increased from HK\$39.8 million as of December 31, 2015 to HK\$42.1 million as of December 31, 2016 primarily because of increases in (i) provision for sales rebate which was generally in line with our business growth, (ii) bonus accrued that is payable to our staff, which was generally in line with the growth of our beverage solutions business and (iii) provision of sales rebate which was generally in line with growth in scale of our business.

Our accruals and other payables increased to HK\$59.2 million as of December 31, 2017 mainly because of an increase in (i) accrued expenses, which in turn, was mainly a result of expenses we accrued in relation to the Global Offering, and (ii) bonus accrued that is payable to our staff, which was generally in line with the growth of our business.

Goodwill

As of December 31, 2015, 2016 and 2017, our goodwill amounted to HK\$15.4 million, HK\$15.4 million and HK\$15.4 million, respectively which arose from our acquisition of the frozen food business in Hong Kong in 2013 and of the production and wholesale of ice-cream business in the PRC in 2014. Goodwill acquired through business combinations is allocated to the trading of frozen food cash-generating unit and the ice-cream products cash-generating unit for impairment testing.

FINANCIAL INFORMATION

The carrying amount of goodwill allocated to each of the cash-generating units as of the dates indicated is as follows:

	As of December 31,		
	2015 <i>(HK\$'000)</i>	2016 <i>(HK\$'000)</i>	2017 <i>(HK\$'000)</i>
Trading of frozen food cash-generating unit	15,447	15,447	15,447
Ice-cream products cash-generating unit	<u>—</u>	<u>—</u>	<u>—</u>
Carrying amount	<u>15,447</u>	<u>15,447</u>	<u>15,447</u>

During the year ended December 31, 2015, the recoverable amount of the ice-cream products cash-generating unit was determined based on a value in use calculation using cash flow projections based on financial budgets covering a three-year period approved by management. For details, please refer to Note 16 of the Accountants' Report set out in Appendix I to this prospectus. Based on the annual impairment test performed for the year ended December 31, 2015, an impairment loss of HK\$4.9 million had been provided in relation to the ice-cream products cash-generating unit. The impairment loss was a result of poor performance and keen competition of ice-cream products in the PRC market. We discontinued our ice cream operation in 2016. Please refer to the section headed "Business — Discontinued Operation" in this prospectus for details.

Based on the results of the goodwill impairment testing, the estimated recoverable amount of the trading of frozen food cash-generating unit exceeded its carrying amount by approximately HK\$23,510,000, HK\$27,238,000, HK\$30,177,000 as of December 31, 2015, 2016 and 2017, respectively. The following table demonstrates the increase in discount rate or the decrease in budgeted gross margin at the end of each of the Track Record Period that would result in the recoverable amount of the trading of frozen food cash-generating unit being approximately equal to its carrying amount:

	As at December 31,		
	2015 %	2016 %	2017 %
An increase in discount rate	<u>31.2</u>	<u>30.7</u>	<u>33.0</u>
Or			
A decrease in budgeted gross margin	<u>20.4</u>	<u>24.5</u>	<u>19.7</u>

In the opinion of the Directors, any reasonably possible changes in the key assumptions on which the recoverable amount is based would not cause the relevant cash generating unit's carrying amount to exceed its recoverable amount.

FINANCIAL INFORMATION

CAPITAL EXPENDITURES**Historical Capital Expenditures**

Our capital expenditures principally consisted of expenditures on leasehold land and buildings and plant and machinery during the Track Record Period. For the years ended December 31, 2015, 2016 and 2017, we incurred additions of property, plant and equipment in the amounts of HK\$36.2 million, HK\$23.7 million and HK\$16.8 million, respectively. A substantial portion of our historical capital expenditures were incurred in relation to coffee machines which we purchased and leased to our customers. Our capital expenditure for the year ended December 31, 2015 was larger than 2016 and 2017 because of costs we incurred in relation to the construction of the tea processing plant and the installation of the tea processing line in the PRC. In particular, we incurred HK\$11.5 million of leasehold land and buildings fees in 2015, which primarily related to the construction of the tea processing plant. The following table sets out our additions of property, plant and equipment for the periods indicated:

	For the year ended December 31,		
	2015	2016	2017
	<i>(HK\$'000)</i>	<i>(HK\$'000)</i>	<i>(HK\$'000)</i>
Leasehold land and buildings	11,475	65	—
Plant and machinery	17,726	20,028	12,433
Furniture, fixtures and equipment	5,275	2,171	3,346
Motor vehicles	<u>1,760</u>	<u>1,423</u>	<u>992</u>
Total	<u>36,236</u>	<u>23,687</u>	<u>16,771</u>

Planned Capital Expenditures

As part of our future growth strategy, we plan to purchase more machinery to support our beverage solutions business, primarily coffee machines to be leased to our customers, and to further invest in furniture, fixtures and equipment and motor vehicles. The table below sets forth our planned capital expenditures for the period indicated:

	Year ending December 31, 2018	
	Hong Kong	PRC
	<i>(HK\$'000)</i>	<i>(HK\$'000)</i>
Plant and machinery	12,350	5,307
Furniture, fixtures and equipment	2,074	1,170
Motor vehicles	<u>2,256</u>	<u>—</u>
Total	<u>16,680</u>	<u>6,477</u>

FINANCIAL INFORMATION

We estimate that our planned capital expenditures for the year ending December 31, 2018 will be HK\$23.2 million mainly including expenses (i) in the amount of HK\$17.7 million in plant and machinery, which shall primarily consist of expenditures on coffee machines to be leased to our customers, (ii) in the total of HK\$3.2 million, which shall mainly include expenditures over furniture and fixtures, computer hardware and computer software, and (iii) of HK\$2.3 million for delivery trucks and executive car. The estimated amounts of expenditures set out above may vary from the actual amounts of expenditures for a variety of reasons, including changes in market conditions, competition and other factors.

Our current plan with respect to planned capital expenditures is subject to change based on the evolution of our business plan, including potential acquisitions, the progress of our capital projects, market conditions and our outlook of future business conditions. As we continue to expand, we may incur additional capital expenditures. Our ability to obtain additional funding in the future is subject to a variety of uncertainties, including our future results of operations, economic, political and other conditions in Hong Kong and the PRC, and relevant rules and regulations in Hong Kong and the PRC regarding debt and equity financing. Other than as required by law, we do not undertake any obligation to publish updates of our capital expenditure plans. See “Forward-Looking Statements” in this prospectus for details on cautions about forward-looking statements and information contained in this prospectus.

CONTRACTUAL AND CAPITAL COMMITMENTS
Capital commitments

We have contracted, but not provided for, capital commitments related to property, plant and equipment. The table below sets forth the total amount of our capital commitments as of the dates indicated.

	As of December 31,			As of
	2015	2016	2017	February 28,
	<i>(HK\$'000)</i>	<i>(HK\$'000)</i>	<i>(HK\$'000)</i>	2018 <i>(HK\$'000)</i>
Property, plant and equipment				
— Contracted, but not provided for	<u>749</u>	<u>1,285</u>	<u>739</u>	<u>688</u>

FINANCIAL INFORMATION

Operating lease commitments

We lease a number of our warehouses, offices and retail stores under non-cancellable operating lease agreements. Leases for properties are negotiated for terms ranging from one to four years. The table below sets forth our total future minimum lease payments under non-cancellable operating leases falling due as of the dates indicated.

	As of December 31,			As of
	2015	2016	2017	February 28,
	(HK\$'000)	(HK\$'000)	(HK\$'000)	2018 (HK\$'000)
Within one year	9,792	7,472	9,779	8,516
In the second to fifth years, inclusive	<u>8,670</u>	<u>5,219</u>	<u>7,719</u>	<u>6,589</u>
Total	<u>18,462</u>	<u>12,691</u>	<u>17,498</u>	<u>15,105</u>

INDEBTEDNESS

As of December 31, 2015, 2016 and 2017, we had total borrowings of HK\$174.8 million, HK\$173.9 million and HK\$191.6 million, respectively.

FINANCIAL INFORMATION

The following table sets forth the components of our borrowings as of the dates indicated:

Interest-bearing bank borrowings	As of December 31,			As of
	2015	2016	2017	February 28,
	<i>(HK\$'000)</i>	<i>(HK\$'000)</i>	<i>(HK\$'000)</i>	2018
				<i>(HK\$'000)</i>
				(unaudited)
Current				
Trust receipt loans —				
unsecured	73,839	74,516	84,245	81,408
Bank loans — unsecured	7,988	18,000	38,000	51,600
Current portion of long term bank loans				
— unsecured	33,663	10,529	11,355	11,369
— secured	—	27,585	5,200	5,200
	<u>115,490</u>	<u>130,630</u>	<u>138,800</u>	<u>149,577</u>
Non-current				
Bank loans				
— unsecured	59,344	8,754	36,292	34,397
— secured	—	34,481	16,467	15,600
	<u>59,344</u>	<u>43,235</u>	<u>52,759</u>	<u>49,997</u>
Total borrowings	<u>174,834</u>	<u>173,865</u>	<u>191,559</u>	<u>199,574</u>
Maturity of borrowings				
Within one year	113,559	130,630	138,800	149,577
In the second year	36,147	35,739	16,668	16,687
In the third to fifth year, inclusive	25,128	7,496	36,091	33,310
	<u>174,834</u>	<u>173,865</u>	<u>191,559</u>	<u>199,574</u>
Weighted average interest rate				
Bank borrowings	<u>2.35%</u>	<u>2.40%</u>	<u>2.52%</u>	<u>2.84%</u>

FINANCIAL INFORMATION

During the Track Record Period, our current portion of bank borrowings bore effective interest rates ranging from 1.73% to 3.80% per annum with details set out in Note 29 of the Accountants' Report set out in Appendix I to this prospectus.

As of February 28, 2018, being the latest practicable date for determining our indebtedness, we had outstanding indebtedness (including bank borrowings and loans) of HK\$201.8 million and unutilized credit facilities of HK\$120.0 million from commercial banks. Save as disclosed above, we did not have any other loan capital issued and outstanding or agreed to be issued, bank overdrafts, loans or other similar indebtedness, liabilities under acceptances or acceptable credits, debentures, mortgages, charges, hire purchases commitments, guarantees or other material contingent liabilities.

Our Directors confirm that (i) the agreements under our borrowings do not contain any covenant that will have a material and adverse effect on our ability to make additional borrowings or issue debt or equity securities in the future, (ii) we had no material defaults in payment of trade and non-trade payables and bank and other borrowings, nor did we breach any covenants during the Track Record Period and up to the Latest Practicable Date, (iii) during the Track Record Period and up to the Latest Practicable Date, we did not experience any material difficulty in obtaining credit facilities, or withdrawal of facilities or request for early payment, and (iv) as of the Latest Practicable Date, we did not have any plan to raise material external debt financing.

LISTING EXPENSES

We incurred Listing expenses (excluding underwriting commission) of HK\$28.7 million during the Track Record Period, of which HK\$25.0 million was recognized as administrative expenses and the remainder will be deducted from equity upon the Listing. We expect to incur further Listing expenses of approximately HK\$17.0 million, including underwriting commission (assuming an Offer Price of HK\$1.84, being the mid-point of the Offer Price range stated in this prospectus), of which HK\$8.1 million will be recognized as administrative expenses for the year ending December 31, 2018, and the remaining will be deducted from equity upon the Listing. Listing expenses incurred for engagement of professional parties in connection with the Listing and the underwriting commission relating to underwriting the new Shares of the Global Offering are to be borne by our Company as all professional services rendered in connection with the Listing are for our Company's benefits and interests to be brought by its listing status. Our Company will not have any interest in the sale of the Sale Shares and therefore any underwriting commission, fees and expenses in that regard will be borne by the Selling Shareholder.

FINANCIAL INFORMATION

FINANCIAL RATIOS

The following table sets forth certain financial ratios of our Group for the periods and as of the dates indicated:

	As of or for the year ended		
	December 31,		
	2015	2016	2017
Current Ratio ⁽¹⁾	1.6	1.8	1.5
Quick Ratio ⁽²⁾	0.9	1.2	0.8
Gearing Ratio ⁽³⁾	70.7%	62.3%	89.4%
Return on Equity ⁽⁴⁾	16.7%	23.3%	21.5%
Return on Assets ⁽⁵⁾	7.0%	11.1%	8.3%
Net Profit Margin — With loss/profit from a Discontinued Operation ⁽⁶⁾	4.7%	7.7%	5.1%
Net Profit Margin — Continuing Operations ⁽⁷⁾	5.6%	7.6%	5.1%
Net Debt to Equity Ratio ⁽⁸⁾	46.5%	45.0%	68.1%

Notes:

- (1) Current ratio is equal to current assets divided by current liabilities as of the end of the year.
- (2) Quick ratio equals our current assets less inventories divided by current liabilities as of the end of the year.
- (3) Gearing ratio equals total debt divided by equity attributable to owners of the parent. Our total debt represents interest-bearing bank borrowings.
- (4) Return on equity represents our profit for the year attributable to owners of the parent as a percentage of equity attributable to owners of the parent as of the end of the same year.
- (5) Return on assets represents our profit for the year as a percentage of total assets as of the end of the same period.
- (6) Net profit margin is equal to our profit for the year divided by our total revenue for the same period.
- (7) Net profit margin is equal to our profit from continuing operations for the year divided by our total revenue from continuing operations for the same period.
- (8) Net debt to equity ratio equals net debt divided by equity attributable to owners of the parent at the end of the year. Net debt represents interest-bearing bank borrowings, less cash and cash equivalents.

FINANCIAL INFORMATION

Current Ratio

Our current ratio was 1.6, 1.8 and 1.5 as of December 31, 2015, 2016 and 2017, respectively. Our current ratio increased from 1.6 as of December 31, 2015 to 1.8 as of December 31, 2016 primarily because of an increase in loans to the ultimate holding company and amounts due from the ultimate holding company as of December 31, 2016. Our current ratio decreased to 1.5 as of December 31, 2017 primarily due to reduction in loans to the ultimate holding company and amount due from the ultimate holding company and increase in interest-bearing bank borrowings.

Quick Ratio

Our quick ratio was 0.9, 1.2 and 0.8 as of December 31, 2015, 2016 and 2017, respectively. Our quick ratio increased from 0.9 as of December 31, 2015 to 1.2 as of December 31, 2016, primarily because of increases in loans to the ultimate holding company, amounts due from the ultimate holding company and decreases in trade and bills payables. Our quick ratio subsequently decreased to 0.8 as of December 31, 2017 primarily because of reduction in loans to the ultimate holding company and amount due from the ultimate holding company and increase in interest-bearing bank borrowings.

Gearing Ratio

Our gearing ratio was 70.7%, 62.3% and 89.4% as of December 31, 2015, 2016 and 2017, respectively. Our gearing ratio decreased from 70.7% as of December 31, 2015 to 62.3% as of December 31, 2016, respectively, primarily because of decrease in our total interest-bearing bank borrowings and increase in our total equity attributable to owners of the parent. In turn, increase in our total equity attributable to owners of the parent is mainly a result of a growth in our reserves contributed by our retained profit. Our gearing ratio subsequently increased to 89.4% as of December 31, 2017 primarily because of increase in our total interest-bearing bank borrowings for working capital purpose and decrease in our total equity attributable to owners of the parent, which in turn, is a result of a decrease in our reserves because of dividend payment.

Return on Equity

Our return on equity was 16.7%, 23.3% and 21.5% for the year ended December 31, 2015, 2016 and 2017, respectively. Our return on equity increased to 23.3% as of December 31, 2016 primarily because of an increase in our net profit. Our return on equity decreased slightly from 23.3% for the year ended December 31, 2016 to 21.5% for the year ended December 31, 2017 mainly as a result of decrease in our net profit for the year, which in turn was primarily a result of the Listing expenses incurred in relation to our Global Offering and decrease in other income and gains.

FINANCIAL INFORMATION

Return on Assets

Our return on assets was 7.0%, 11.1% and 8.3% for the year ended December 31, 2015, 2016 and 2017, respectively. Our return on assets increased from 7.0% for the year ended December 31, 2015 to 11.1% for the year ended December 31, 2016, primarily because of growth in our net profit. Our return on assets decreased from 11.1% for the year ended December 31, 2016 to 8.3% for the year ended December 31, 2017, primarily because of the decrease in our net profit exceeding the effect of the decrease in our total assets, which mainly resulted from the settlement of loans to the ultimate holding company and amount due from the ultimate holding company through dividends.

Net Profit Margin (including the financial results of the discontinued operation)

Our net profit margin was 4.7%, 7.7% and 5.1% for the year ended December 31, 2015, 2016 and 2017, respectively. Our net profit margin increased from 4.7% for the year ended December 31, 2015 to 7.7% for the year ended December 31, 2016 primarily because of an increase in our net profit. Our net profit margin subsequently decreased to 5.1% for the year ended December 31, 2017 primarily because of the decrease in our net profit primarily due to an increase in expenses for the Global Offering and decrease in other income and gains for the year.

Net Profit Margin (excluding the financial results of the discontinued operation)

Our net profit margin was 5.6%, 7.6% and 5.1% for the year ended December 31, 2015, 2016 and 2017, respectively. Our net profit margin increased from 5.6% for the year ended December 31, 2015 to 7.6% for the year ended December 31, 2016, primarily because of the increase in our net profit. Our net profit margin decreased to 5.1% for the year ended December 31, 2017 because of the decrease in our net profit primarily due to an increase in expenses for the Global Offering and decrease in other income and gains for the year.

Net Debt to Equity Ratio

Our net debt to equity ratio was 46.5%, 45.0% and 68.1% as of December 31, 2015, 2016 and 2017, respectively. Our net debt to equity ratio decreased from 46.5% as of December 31, 2015 to 45.0% as of December 31, 2016, primarily because of decreases in our total interest-bearing bank borrowings and increase in our total equity. In turn, the increase in our total equity was mainly a result of a growth in our reserves contributed by our retained profit. Our net debt to equity ratio subsequently increased to 68.1% as of December 31, 2017 primarily because of an increase in net debt and a decrease in our equity following our dividend payment.

FINANCIAL INFORMATION

RELATED PARTY TRANSACTIONS

The following table sets forth the balances with related parties as of the dates indicated:

	As of December 31,		
	2015	2016	2017
	<i>(HK\$'000)</i>	<i>(HK\$'000)</i>	<i>(HK\$'000)</i>
Due from related companies			
Bofon — Bofon International Development (Holdings) Limited	—	20	—
HKDD — Dandy Don's American Ice-Cream Factory Limited	—	744	—
DD(GZ)CC — Dandy Don's (Guangzhou) Catering Company Limited	—	1,024	—
GZDD — Guangzhou Dandy Don's Ice-cream Factory Company Limited	—	5,426	—
	<u>—</u>	<u>7,214</u>	<u>—</u>
Due from the ultimate holding company			
— Hero Valour Limited	<u>—</u>	<u>35,261</u>	<u>—</u>
Loans to the ultimate holding company			
— Hero Valour Limited	<u>—</u>	<u>42,849</u>	<u>—</u>

As of December 31, 2016, we had amounts due from related companies in the amount of HK\$7.2 million which primarily consisted of funds we advanced such related parties for their operational use, including purchase of raw material and settlement of their daily operational expenses, and fund transfers for capital injections. The balances with related companies and the ultimate holding company above are non-trade related, unsecured and are repayable on demand. Except for the loans to the ultimate holding company as at December 31, 2016 of HK\$42.8 million which bore interest at the Hong Kong Interbank Offered Rate plus 1.5% per annum, the remaining balances are interest-free.

FINANCIAL INFORMATION

In addition, we had the following material transactions with related parties for the periods indicated:

	Years ended December 31,		
	2015	2016	2017
	<i>(HK\$'000)</i>	<i>(HK\$'000)</i>	<i>(HK\$'000)</i>
Purchases from the Former Shareholder and its affiliates (<i>Note</i>)	145,036	19,303	—
Purchases from GZDD	—	606	920
Rental expenses paid to Telenice	1,920	1,860	1,860
Interest income earned from the ultimate holding company	<u>—</u>	<u>489</u>	<u>419</u>

Note: The transaction amounts for the purchases from the Former Shareholder and its affiliates relate to the period from October 17, 2014 to March 2, 2016 only, during which the Former Shareholder remained as our Shareholder and thus constituted our related party. For further details, please refer to the section headed “History, Development and Corporate Structure — History and Business Development — Material Development after Delisting — (f) Share Subscription Agreement” in this prospectus.

Purchases from the Former Shareholder of our Company (being one of our major suppliers) and its affiliates comprised purchases of coffee beans, tea leaves, milk and frozen meat products. These transactions will continue after the Listing but do not constitute related party transactions of our Company.

Purchases from GZDD comprised purchases of ice-cream by our Group relating to the purchase transactions which took place from June 1, 2016 onwards after GZDD had ceased to be a subsidiary of our Group following the disposal of the ice-cream business completed on May 31, 2016. These transactions will continue after the Listing and constitute continuing connected transactions of our Company. For further details, please refer to the sections headed “History, Development and Corporate Structure — History and Business Development — Material Development after Delisting” and “Continuing Connected Transactions — Fully Exempt Continuing Connected Transactions — Purchase of ice-cream from GZDD” in this prospectus.

Rental expenses paid to Telenice, an associate of Mr. Wong being our Controlling Shareholder, comprised management fees, rates and fixtures in connection with lease agreements entered annually to lease a residential premises located at House H3, Belleview Place, 93 Repulse Bay Road, Hong Kong, to our Company used as Mr. Wong’s corporate housing as part of his remuneration package. These transactions will continue after the Listing and constitute continuing connected transactions of our Company. For further details, please refer to the section headed “Continuing Connected Transactions — Fully Exempt Continuing Connected Transactions — Lease of residential premises” in this prospectus.

FINANCIAL INFORMATION

Interest income earned from the ultimate holding company was based on rates in the range of Hong Kong Interbank Offered Rate plus 1.5% per annum for the years ended December 31, 2016 and 2017.

Our Directors confirm that these transactions (i) were conducted on normal commercial terms and were not less favorable to us than terms available to or from Independent Third Parties, and (ii) would not distort our Group's track record results or make our historical results not reflective of our future performance.

OFF BALANCE SHEET COMMITMENTS AND ARRANGEMENTS

As of the Latest Practicable Date, we had not entered into any off balance sheet transactions except as disclosed in the paragraph headed "Contractual and Capital Commitments" in this section.

DISTRIBUTABLE RESERVES

As of December 31, 2017, we had distributable reserves of HK\$21.7 million which relate to retained profits, and are available for distribution to our equity holders.

DIVIDENDS

During the years ended December 31, 2015, 2016 and 2017, we declared dividends with an amount of HK\$28.1 million, HK\$23.3 million and HK\$122.9 million, respectively, of which HK\$28.1 million, HK\$13.0 million and HK\$14.5 million were respectively settled in cash and nil, HK\$10.3 million, and HK\$108.4 million were respectively set off either against the loans to the ultimate holding company or against the amount due from the ultimate holding company during the years ended December 31, 2015, 2016 and 2017, respectively. We also declared a final dividend for the year of 2017 totalling HK\$10.0 million for the year ended December 31, 2017 in January 2018, which was settled in cash and an interim dividend for the year ending December 31, 2018 totalling HK\$8.1 million in April 2018, which has not been settled as at the Latest Practicable Date.

We may distribute dividends in amounts not less than 35% of our net profit for a financial year by way of cash or by other means that we consider appropriate. A decision to declare and pay any dividends would require the approval of the Board and will be at their discretion. In addition, any final dividend for a financial year will be subject to Shareholders' approval. The Board will review our dividend policy from time to time in light of our results of operations, our cash flows, our financial condition, our Shareholders' interest, our capital requirements, the general business conditions and strategies, the payment by our subsidiaries of cash dividends to us, and other factors the Board may deem relevant in determining whether dividends are to be declared and paid.

FINANCIAL INFORMATION

DISCLOSURE REQUIRED UNDER CHAPTER 13 OF THE LISTING RULES

Pursuant to Rule 13.18 of the Listing Rules, a general disclosure obligation will arise where an issuer or any of its subsidiaries enters into a loan agreement that includes a condition imposing specific performance obligations on any controlling shareholders, such as a requirement to maintain a specified minimum holding in the share capital of the listed issuer.

Pursuant to the terms of two banking facilities granted to our Group, Mr. Wong has undertaken that he shall maintain not less than 51% issued share capital of our Company through Hero Valour and under the term of one of these banking facilities, he shall also remain as the chairman or executive Director of our Company. The total amount of such facilities granted amounted to HK\$138.2 million as of the Latest Practicable Date with maturity ranging from four months for the trade finance to five years until the first quarter of 2022 for the term loans.

Save as disclosed above, our Directors have confirmed that, as of the Latest Practicable Date, there were no circumstances which have given rise to a disclosure requirement under Rules 13.13 to 13.19 of the Listing Rules.

MATERIAL ADVERSE CHANGE

Our Directors confirm that, save for the Listing expenses as disclosed in the paragraph headed “Listing Expenses” above which we expect may affect our financial results for 2018, up to the date of this prospectus, there had been no material adverse change in our financial or trading position since December 31, 2017 (being the latest date of which our audited consolidated financial statements were made up as set out in the Accountants’ Report as Appendix I to this prospectus).

UNAUDITED PRO FORMA ADJUSTED CONSOLIDATED NET TANGIBLE ASSETS

The following unaudited pro forma adjusted consolidated net tangible assets have been prepared in accordance with Rule 4.29 of the Listing Rules and with reference to Accounting Guideline 7 “Preparation of Pro Forma Financial Information for Inclusion in Investment Circulars” issued by the Hong Kong Institute of Certified Public Accountants for illustration purposes only, and is set out here to illustrate the effect of the Global Offering on our consolidated net tangible assets attributable to owners of the parent as of December 31, 2017 as if it had taken place on December 31, 2017.

FINANCIAL INFORMATION

The unaudited pro forma adjusted consolidated net tangible assets have been prepared for illustrative purposes only and because of its hypothetical nature, it may not give a true picture of the financial position of our Group had the Global Offering been completed as of December 31, 2017 or any future date. It is prepared based on our consolidated net tangible assets as of December 31, 2017 as set out in the Accountants' Report as Appendix I to this prospectus, and adjusted as described below. The unaudited pro forma adjusted consolidated net tangible assets does not form part of the Accountants' Report as set out in Appendix I to this prospectus.

	Consolidated net tangible assets attributable to owners of the parent as at December 31, 2017 HK\$'000 (Note 1)	Estimated net proceeds from the Global Offering HK\$'000 (Note 2)	Unaudited pro forma adjusted consolidated net tangible assets HK\$'000	Unaudited pro forma adjusted consolidated net tangible assets per Share HK\$ (Note 3 and 4)
Based on the Offer Price of HK\$1.50 per Share	193,702	143,735	337,437	0.47
Based on the Offer Price of HK\$2.19 per Share	193,702	214,248	407,950	0.56

Notes:

- (1) The audited consolidated net tangible assets attributable to owners of the parent as at December 31, 2017 is extracted from the Accountants' Report set out in Appendix I to this prospectus, which is based on the audited consolidated equity attributable to owners of the parent as at December 31, 2017 of HK\$214.2 million with adjustments for goodwill and intangible assets of HK\$20.5 million.
- (2) The estimated net proceeds from the Global Offering are based on the Offer Price of HK\$1.50 and HK\$2.19 per Offer Share, being the minimum Offer Price and maximum Offer Price of the Offer Price range, after deduction of the underwriting fees and other Listing related expenses expected to be incurred subsequent to December 31, 2017, and without taking into account of any Shares which may be issued upon exercise of the Over-allotment Option or any options which have been granted under the Pre-IPO Share Option Scheme or may be granted under the Share Option Scheme.
- (3) The unaudited pro forma adjusted consolidated net tangible assets per Share is calculated based on 723,979,312 Shares expected to be in issue immediately following the completion of the Global Offering without taking into account of any Shares which may be issued upon exercise of the Over-allotment Option or of any options which have been granted under the Pre-IPO Share Option Scheme or may be granted under the Share Option Scheme.
- (4) The unaudited pro forma adjusted consolidated net tangible assets attributable to owners of the parent does not take into account a final dividend of HK\$10.0 million for the year ended December 31, 2017 and an interim dividend of HK\$8.1 million for the year ending December 31, 2018 declared on January 23, 2018 and April 19, 2018, respectively. Had the dividend been taken into account, the unaudited pro forma adjusted consolidated net tangible assets of the Group per Share would have been HK\$0.44 and HK\$0.54 at the Offer Price of HK\$1.50 and HK\$2.19, respectively, which is calculated based on 723,979,312 Shares expected to be in issue immediately following the completion of the Global Offering without taking into account of any Shares which may be issued upon exercise of the Over-allotment Option or of any options which have been granted under the Pre-IPO Share Option Scheme or may be granted under the Share Option Scheme.

FINANCIAL INFORMATION

FINANCIAL RISK MANAGEMENT OBJECTIVES AND POLICIES

Our activities expose us to a variety of financial risks, including foreign currency risk, interest rate risk, credit risk and liquidity risk. Our overall risk management program focuses on the unpredictability of financial markets and seeks to minimize potential adverse effects on our financial performance.

Our Directors focus on minimizing potential adverse effects on our Group's financial performance.

Foreign currency risk

We have transactional currency exposures which mainly arise from sales or purchases by operating units in currencies other than the units' functional currency. The majority of our foreign currency purchase transactions are denominated in US\$. On the other hand, the sales and disbursements are mainly denominated in HK\$ and RMB. As HK\$ is pegged to US\$, we do not anticipate significant movements in the US\$/HK\$ exchange rate and the exposure on foreign currency risk is not material.

Our risk management principle with regard to our foreign currency denominated monetary assets, liabilities, commitments, and cash flows is to match as far as possible the values of such assets and cash flows against similarly denominated liabilities and cash flows. Decisions on either holding net short or long positions in foreign currency denominated monetary assets or liabilities are taken on case-by-case basis and by taking into consideration the amount and duration of the expenses, market volatility, economic trends and requirements of the business.

Interest rate risk

Our exposure to the risk of changes in market interest rates relates primarily to our interest-bearing bank borrowings with floating interest rates. We monitor interest rate exposure and will consider hedging significant interest rate risk should the need arise.

As of December 31, 2015, 2016 and 2017, if the interest rates on floating rate bank borrowings denominated in Hong Kong dollar had been 50 basis points higher/lower, which was considered reasonably possible by our Directors, with all other variables held constant, the profit before tax from continuing operations for the year ended December 31, 2015, 2016 and 2017 would have been decreased/increased by HK\$564,000, HK\$372,000 and HK\$636,000, respectively, as a result of higher/lower interest expenses on bank borrowings.

FINANCIAL INFORMATION

Credit risk

We trade only with recognised and creditworthy third parties. It is our policy that all customers who wish to trade on credit terms are subject to credit verification procedures. In addition, receivable balances are monitored on an ongoing basis and our exposure to bad debts is not significant.

The credit risk of our other financial assets, which comprise cash and cash equivalents, financial investment at fair value through profit or loss, financial assets included in prepayments, deposits and other receivables, loans to and amounts due from the ultimate holding company and related companies, arises from default of the counterparties, with a maximum exposure equal to the carrying amounts of these instruments.

As of December 31, 2015, 2016, and 2017, we had certain concentrations of credit risk as 8%, 4% and 6% and 26%, 25% and 29% of our trade receivables as of December 31, 2015, 2016 and 2017 were due from our largest debtor and the five largest debtors, respectively.

Liquidity risk

Our objective is to ensure there are adequate funds to meet our liquidity requirements in the short and longer terms. In the management of liquidity risk, we have been maintaining a cash pooling system where excess liquidity is equalised internally through inter-group accounts. Depending on the specific requirements of each funding agreement, funding for our operating companies may be sourced directly from our bankers or indirectly through our Company.

RELATIONSHIP WITH OUR CONTROLLING SHAREHOLDERS

OVERVIEW

Upon Listing, our Company will be owned as to approximately 66.96% by Hero Valour (without taking into account any Shares which may be allotted and issued upon the exercise of the Over-allotment Option and the options which have been granted under the Pre-IPO Share Option Scheme or which may be granted under the Share Option Scheme). Hero Valour is an investment holding company incorporated in the BVI and wholly-owned by Mr. Wong. Mr. Wong through Hero Valour will become our Controlling Shareholder under the Listing Rules.

We are a leading integrated B2B coffee and black tea solutions provider in Hong Kong, Macau and the PRC with an established food products business. During the Track Record Period, we derived our revenue from two major business segments, namely beverage solutions and food products. Under our beverage solutions segment, we provide house-blend and customized products to our customers mainly in Hong Kong, Macau and the PRC. While for our food products segment, we are primarily engaged in the trading of frozen meat and frozen processed food under worldwide trusted brands.

Our Directors are of the view that to the best of their knowledge and belief, none of our Controlling Shareholders and their respective close associates have interests in businesses which compete, or are likely to compete, either directly or indirectly, with our business.

Apart from his interest in our Group, Mr. Wong also owns equity interests in certain other companies, which are engaged in the business of (i) manufacturing and sales of ice-cream (the “**Ice-cream Business**”); and (ii) operation of Cha Chaan Teng in the PRC (the “**Cha Chaan Teng Business**”, together with the Ice-cream Business, the “**Non-Group Business**”), which do not overlap with our principal business. Our Directors are of the view that the Non-Group Business does not and will not give rise to any direct or indirect competition with the business of our Group in light of the reasons set out in the paragraphs headed “No Competition and Clear Delineation of Business” in this section.

RELATIONSHIP WITH OUR CONTROLLING SHAREHOLDERS

NO COMPETITION AND CLEAR DELINEATION OF BUSINESS**The Non-Group Business****(a) Ice-cream Business**

Mr. Wong owns equity interests in certain companies engaging in the Ice-cream Business, details of which are set forth below:

	Name of company	Percentage of interest held by Mr. Wong	Principal business activities
1.	Hero Ace	100%	Investment holding vehicle of a group of companies engaging in the ice-cream business, as set forth in company nos. 2–6 below
2.	Elect Gold	100%	Investment holding
3.	HKDD	80%	Investment holding
4.	Bofon	80%	Ice-cream trademark holding
5.	GZDD <i>(Notes 1 and 2)</i>	80%	Manufacturing and wholesale of ice-cream in the PRC
6.	DD(GZ)CC <i>(Note 2)</i>	80%	Retail sales of ice-cream in the PRC

Note 1: SHTW and DGTW have been procuring ice-cream from GZDD during the Track Record Period and they have entered into an ice-cream supply agreement on December 15, 2017. The Ice-cream Business was disposed of by our Company during the Track Record Period. For further details, please refer to the section headed “History, Development and Corporate Structure — History and Business Development — Material Development after Delisting — (b) Incorporation, Acquisitions and Disposal of Elect Gold” in this prospectus. As a result of the disposal, the supply of ice-cream, which will continue after the Listing, will constitute continuing connected transactions of our Company. For further details, please refer to the section headed “Continuing Connected Transactions — Fully Exempt Continuing Connected Transactions — Purchase of Ice-cream from GZDD” in this prospectus.

Note 2: SHTW has been supplying beverage products to GZDD and DD(GZ)CC during the Track Record Period and they have entered into a beverage products supply agreement on December 15, 2017. These transactions will continue after the Listing and constitute continuing connected transactions of our Company. For further details, please refer to the section headed “Continuing Connected Transactions — Fully Exempt Continuing Connected Transactions — Supply of beverage products to GZDD and DD(GZ)CC” in this prospectus. For details regarding the shareholding relationship between Mr. Wong, GZDD and DD(GZ)CC, please refer to the section headed “Continuing Connected Transactions — Connected Persons of our Group” in this prospectus.

Subsequent to our disposal of the Ice-cream Business and as of the Latest Practicable Date, our Group did not engage in the manufacturing of ice-cream. Although our Group was engaged in the sales of ice-cream during the Track Record Period, it had never been and is not expected to be part of our core business. With a view to maximize the synergy effects after our incorporation of Elect Gold on December 18, 2013, we increased our sales effort on ice-cream to our customers. After the disposal of the Ice-cream Business on May 31, 2016, some of these customers

RELATIONSHIP WITH OUR CONTROLLING SHAREHOLDERS

continued to order ice-cream from us. The revenue generated from the sales of ice-cream accounted for approximately 0.1%, 0.1% and 0.1% of our total revenue (excluding the revenue generated from the Ice-cream Business) for the years ended December 31, 2015, 2016 and 2017, respectively. We mainly sell ice-cream to our customers as part of our one-stop shop services of our products. From time to time, we source trading goods including ice-cream that can effectively expand our product portfolio to promote one-stop purchasing experience or cater for specific needs of our customers.

(b) Cha Chaan Teng Business

Mr. Wong owns equity interests in certain companies engaging in the Cha Chaan Teng Business, details of which are set forth below:

Name of company	Percentage of interest held by Mr. Wong	Principal business activities
1. Sweet Saint Catering (HK) Limited (甜聖美食(香港)有限公司)	60%	Trademark holding company
2. Tinbo International Limited	60%	Investment holding
3. Shanghai Tiansheng Beverage Company Limited (上海甜聖餐飲有限公司) ("Shanghai Tiansheng") <i>(Note 3)</i>	60%	Operation of Cha Chaan Teng in the PRC

Note 3: During the Track Record Period, SHTW supplied beverage products including tea bags, coffee powder, sugar, syrup and milk to Shanghai Tiansheng pursuant to a beverage products supply agreement entered into between them. For the year ended December 31, 2015, 2016 and 2017, the amount of sales by SHTW to Shanghai Tiansheng amounted to approximately HK\$58,000, HK\$133,000 and nil, respectively. Such transactions were discontinued since January 2017 and will not continue after the Listing.

Our Group does not operate any Cha Chaan Teng. The Cha Chaan Teng Business is a group of companies engaging in the operation of Cha Chaan Teng in the PRC, which offers Hong Kong cuisines including Hong Kong-style milk tea and coffee. The Cha Chaan Teng Business relies on its suppliers to provide beverage solutions as it does not engage in coffee and tea processing.

Reasons for Exclusion of the Non-Group Business

The Ice-cream Business and the Cha Chaan Teng Business are separate, distinct and clearly delineated from our principal business. We consider that it would be commercially justifiable to exclude the Non-Group Business from our Group. From a strategic perspective, the Non-Group Business is not the core business which our Group intends to focus on. From an operational perspective, the expertise and resources required for the operation of our principal business are different from those required for the Non-Group Business. As such, we are of the view that the injection of or maintaining the Non-Group Business into our Group is not in line with our continuing efforts to focus our resources on the operation of our principal business.

RELATIONSHIP WITH OUR CONTROLLING SHAREHOLDERS

DEED OF NON-COMPETITION

Each of our Controlling Shareholders (each a “**Covenantor**”, collectively the “**Covenantors**”) has entered into the Deed of Non-Competition in favour of our Company and has jointly and severally undertaken and covenanted with our Company (for itself and as trustee of its subsidiaries) that he or it shall not, and shall procure companies controlled by him or it (other than members of our Group) not to at any time during the period that the Deed of Non-Competition remains effective, directly or indirectly, either on his or its own account or in conjunction with or on behalf of any person, firm or company (in each case whether as a shareholder, partner, agent, employee or otherwise):

- (i) carry on, engage, participate, hold any right or interest in or in any way assist in or provide support (whether financial, technical or otherwise) to any business similar to or which competes (either directly or indirectly) or is likely to compete with the business of provision of food and beverage solutions and any other business conducted by our Group from time to time (the “**Restricted Business**”), save for the holding of not more than 10% shareholding interests (individually or any of the Covenantors with their associates collectively) in any listed company in Hong Kong;
- (ii) canvass, solicit, interfere with or endeavour to entice away from members of our Group any person, firm, company or organisation which to his or its knowledge has from time to time or has at any time within the immediate past one (1) year before the date of such solicitation, interference or enticement been a customer, a supplier or a business partner or employee of any member of our Group for the purpose of conducting the Restricted Business;
- (iii) procure orders from or solicit business from any person, firm, company or organisation which to his or its knowledge has dealt with any member of our Group or is in the process of negotiating with any member of our Group in relation to the Restricted Business;
- (iv) do or say anything which may be harmful to the reputation of any member of our Group or which may lead any person to reduce their level of business with any member of our Group or seek to improve their terms of trade with any member of our Group;
- (v) solicit or entice or endeavour to solicit or entice for employment by him or it or companies controlled by him or it (other than members of our Group) or at any time employ or procure the employment of any person who has, at any time within the immediate past one (1) year before the date of such solicitation or employment, been or is a director, manager, employee of or consultant to members of our Group who is or may be likely to be in possession of any confidential information or trade secrets relating to the Restricted Business;

RELATIONSHIP WITH OUR CONTROLLING SHAREHOLDERS

- (vi) make use of any information pertaining to the business of our Group which may have come to his or its knowledge in his or its capacity as a shareholder of our Company or director of any member of our Group for the purpose of conducting the Restricted Business.

In addition, each of the Covenantors has jointly and severally undertaken and covenanted with our Company that if any new business opportunity relating to the Restricted Business (the “**New Business Opportunity**”) is made available to any of the Covenantors or any company controlled by him or it, directly or indirectly, whether individually or together (other than members of our Group), he or it will direct or procure the relevant controlled company to direct the New Business Opportunity to our Group with such required information to enable our Group to evaluate the merits of the relevant New Business Opportunity. The relevant Covenantor will provide or procure the relevant controlled company to provide our Group with all such reasonable assistance to secure such New Business Opportunity.

None of the Covenantors and their relevant controlled companies (other than members of our Group) shall pursue the New Business Opportunity unless our Company decides not to pursue the New Business Opportunity. A Covenantor may only engage in the New Business Opportunity if (i) a notice is received by the Covenantor from our Company confirming that the New Business Opportunity is not accepted and/or does not constitute competition with the Restricted Business (the “**Non-Acceptance Notice**”); or (ii) the Non-Acceptance Notice is not received by the Covenantor within 30 days after the proposal of the New Business Opportunity is received by our Company. Any decision of our Company as to whether or not to pursue the New Business Opportunity will have to be approved by our independent non-executive Directors and the basis for not taking up the New Business Opportunity will be disclosed in the interim and the annual reports of our Company. Our Group will not be required to pay any fees to any of the Covenantors and/or their relevant controlled companies in relation to the New Business Opportunity.

The Deed of Non-Competition and the rights and obligations thereunder are conditional and will take effect immediately upon Listing.

The obligations of the Covenantors under the Deed of Non-Competition shall cease if:

- (a) our Shares cease to be listed on the Main Board of the Hong Kong Stock Exchange; or
- (b) the Controlling Shareholders cease to be the controlling shareholders (as defined under the Listing Rules) of our Company,

whichever occurs first.

Nothing in the Deed of Non-Competition shall prevent our Controlling Shareholders or any of their associates from carrying on any business other than the Restricted Business.

RELATIONSHIP WITH OUR CONTROLLING SHAREHOLDERS

INDEPENDENCE FROM OUR CONTROLLING SHAREHOLDERS

Our Directors consider that we can operate independently from our Controlling Shareholders following completion of the Listing based on the following reasons:

Management independence

Our Board and members of senior management function independently from our Controlling Shareholders. Our Board comprises three executive Directors and three independent non-executive Directors. Our senior management consists of five members. Our Directors believe that we are able to manage our business independently from our Controlling Shareholders based on the following reasons:

- (a) with three independent non-executive Directors out of a total of six Directors in our Board, there will be a sufficiently robust and independent voice within our Board to counter-balance any situation involving a conflict of interest and protect the interests of our independent Shareholders;
- (b) all members of our senior management are full-time employees of our Group and all of them have, for the entire Track Record Period, undertaken supervisory responsibilities in our business operations. The responsibilities of our senior management team include overseeing our daily operations, implementing our business strategies and maintaining risk management and internal control matters. This ensures the independence of the daily management and operations of our Group from those of our Controlling Shareholders;
- (c) each of our Directors has confirmed that neither he/she nor their respective close associates has any interests in businesses which compete, or are likely to compete, either directly or indirectly, with our business and each of our Directors is aware of his/her fiduciary duties as a Director of our Company, which require, among other things, that he/she acts for the benefit and in the best interests of our Shareholders as a whole and do not allow any conflict between his/her duties as a Director and his/her personal interests to affect the performance of his/her duties as a Director;
- (d) connected transactions between our Company and companies controlled by our Controlling Shareholders are subject to the rules and regulations under the Listing Rules including rules relating to announcement, reporting and independent Shareholders' approval (where applicable); and
- (e) a number of corporate governance measures are in place to avoid any potential conflict of interest between our Company and our Controlling Shareholders, and to safeguard the interests of our independent Shareholders. For further details, please refer to the paragraph headed "Corporate Governance Measures" in this section.

RELATIONSHIP WITH OUR CONTROLLING SHAREHOLDERS

Operational independence

Our Directors consider that our Company operates independently from our Controlling Shareholders and companies controlled by our Controlling Shareholders (other than members of our Group) based on the following reasons:

- (a) our Group is the holder of all relevant licenses, trademarks and permits material to the operation of our business and has sufficient capital, equipment and employees to operate our business independently;
- (b) our Group has our own administrative and corporate governance functions, including our own sales, accounting and human resources departments;
- (c) our Company has established a set of internal control procedures to facilitate the effective operation of our business; and
- (d) except for (i) the related party transactions that took place during the Track Record Period as set forth in Note 38 of the Accountants' Report in Appendix I to this prospectus; and (ii) the connected transactions that will continue after the Listing as set forth in the section headed "Continuing Connected Transactions" in this prospectus, the suppliers and customers of our Group are Independent Third Parties. The amount of such transactions constitute a minimal proportion of the total amount of purchase or total amount of sales of our Group (as the case may be).

Financial independence

Our Directors are of the view that our Group will be financially independent of our Controlling Shareholders upon Listing. As of the Latest Practicable Date, all loans and balances due to and from between entities controlled by our Controlling Shareholders and members of our Group have been fully settled. All personal guarantees provided by our Controlling Shareholders to us and corporate guarantees provided by members of our Group to our Controlling Shareholders will be fully released upon Listing. Upon Listing, there will be no amount due to or from between entities controlled by our Controlling Shareholders and members of our Group other than trade-related payables and receivables as contemplated under the continuing connected transactions with details set out in the section headed "Continuing Connected Transactions" in this prospectus.

We have our own accounting and finance department, accounting systems and independent treasury function for cash receipts and payment and independent access to third party financing. Our Directors consider that the finance functions of our Group are therefore independently managed with no reliance on our Controlling Shareholders.

RELATIONSHIP WITH OUR CONTROLLING SHAREHOLDERS

CORPORATE GOVERNANCE MEASURES

Our Company will implement the following corporate governance measures in order to manage conflict of interest following the Listing:

- (a) Any transaction made (or proposed to be made) between any member of our Group and our connected persons will be required to comply with (i) Chapter 14A of the Listing Rules which include, but without limitation to, where applicable, the announcement, reporting, and independent Shareholders' approval requirements; and (ii) such other conditions imposed by the Hong Kong Stock Exchange for the granting of waiver from strict compliance with the relevant requirements under the Listing Rules.
- (b) In respect of any proposed contracts or arrangements entered into or to be entered into between the Controlling Shareholders and any member of our Group, any Director who is considered to be interested in the relevant matter will be required to disclose his/her interests to the Board. Under our Bye-Laws, if a director or any of his/her close associates has any material interest in respect of any contract or arrangement or proposal, the relevant director shall not be counted in the quorum of the relevant meeting of the board of directors for the resolution, and vote on the resolution, approving such contract or arrangement or proposal.
- (c) We have appointed BOSC International Company Limited as our compliance adviser pursuant to Rule 3A.19 of the Listing Rules, which will provide advice and guidance to us with respect to compliance with the Listing Rules, including but not limited to various requirements relating to Directors' duties and corporate governance.
- (d) Each of our Controlling Shareholders has undertaken to provide all information necessary for our independent non-executive Directors to review, on a semi-annual basis, the compliance and the enforcement of the Deed of Non-Competition and will disclose decisions (with basis) on matters reviewed in the interim and the annual reports of our Company or by way of announcement to be published in compliance with the disclosure requirements under the Listing Rules.
- (e) Pursuant to the Corporate Governance Code, our Directors, including our independent non-executive Directors, will be able to seek independent professional advice from external parties in appropriate circumstances at our Company's costs.

CONTINUING CONNECTED TRANSACTIONS

We have entered into certain transactions with parties which will become connected persons upon the Listing and such transactions will constitute continuing connected transactions for our Company under the Listing Rules.

CONNECTED PERSONS OF OUR GROUP

Oriole was owned as to 52.4% and 47.6% by Mr. Chu Sun Chi (“**Mr. Chu**”) and Mr. Chu Cho Wing, the son of Mr. Chu, respectively, until Mr. Chu transferred all his shareholding in Oriole to Mr. Chu Cho Wing on September 4, 2017. Mr. Chu is a director and substantial shareholder of Whole Sun, which is our non-wholly-owned subsidiary. Therefore, Oriole is a connected person of our Company at the subsidiary level because Oriole is an associate of Mr. Chu.

Oriole International is owned as to 51% by Mr. Chu Cho Wing, being the son of Mr. Chu and as to 49% by Ms. Li Sze Mun Charmaine, the daughter-in-law of Mr. Chu. Oriole International is a connected person of our Company at the subsidiary level because Oriole International is an associate of Mr. Chu. Accordingly, the transactions between our Group and Oriole International will constitute connected transactions of our Group upon Listing.

The shareholding relationships (a) between Mr. Chu and Whole Sun; and (b) between Mr. Chu Cho Wing, Oriole and Oriole International as of the Latest Practicable Date are set out in the chart below:

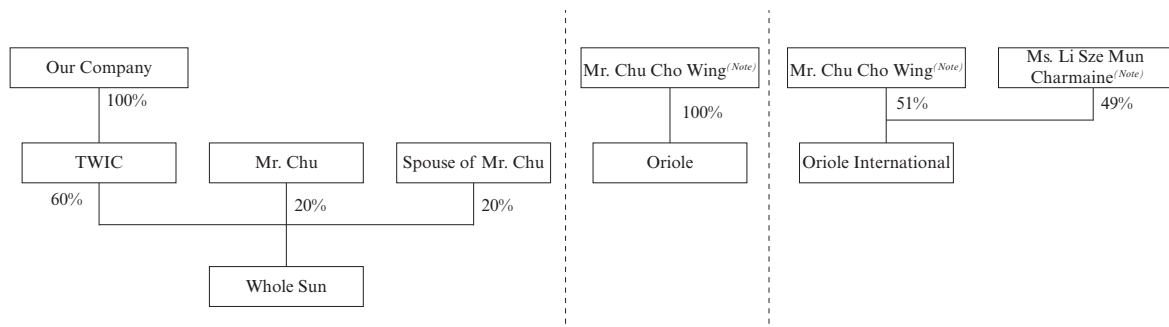

Note: Mr. Chu Cho Wing is the son of Mr. Chu and Ms. Li Sze Mun Charmaine is the daughter-in-law of Mr. Chu.

Each of Telenice, GZDD and DD(GZ)CC is an associate of Mr. Wong, who is our executive Director, chief executive officer and Controlling Shareholder, and therefore is the connected person of our Company pursuant to Rule 14A.12(1)(c) of the Listing Rules. Accordingly, the transactions between our Group and each of Telenice, GZDD and DD(GZ)CC will constitute connected transactions of our Group upon Listing.

CONTINUING CONNECTED TRANSACTIONS

The shareholding relationships between Mr. Wong, Ms. Li Ying Wah Irene (“Ms. Li”) and each of Telenice, GZDD and DD(GZ)CC as of the Latest Practicable Date are set out in the chart below:

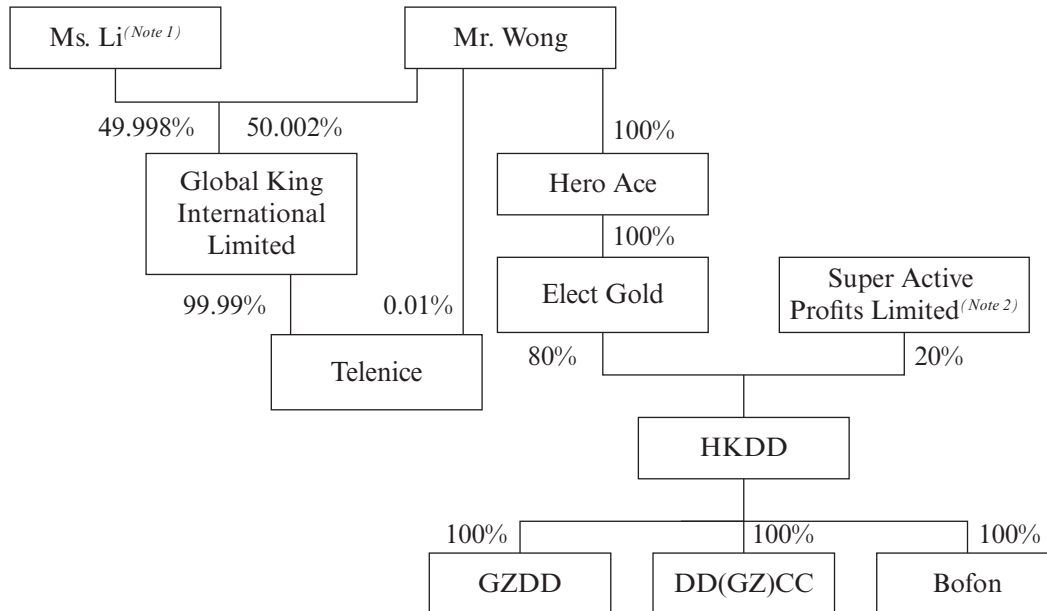

Note 1: Ms. Li is the spouse of Mr. Wong.

Note 2: Super Active Profits Limited is an Independent Third Party.

We set out below a summary of the continuing connected transactions upon the Listing:

Transaction	Connected Persons	Nature of relationship	Historical Figures (HK\$)			Annual Caps (HK\$)		
			Year ended December 31,			Year ended December 31,		
			2015	2016	2017	2018	2019	2020
I. Non-Fully Exempt Continuing Connected Transactions								
1. Frozen Food Supply Agreement	Oriole	Associate of a director of our subsidiary	25,644,000	28,986,000	37,455,000	1,000,000 ^(Note)	N/A	N/A
	Oriole International		N/A	N/A	N/A	40,500,000 ^(Note)	45,300,000	49,000,000
II. Fully Exempt Continuing Connected Transactions								
1. Lease Agreement	Telenice	Associate of our executive Director, chief executive officer and Controlling Shareholder	1,920,000	1,860,000	1,860,000			
2. Ice-cream Supply Agreement	GZDD		N/A	606,000	920,000		N/A	
3. Beverage Products Supply Agreement	GZDD and DD(GZ)CC		N/A	13,000	15,000			

CONTINUING CONNECTED TRANSACTIONS

Note: During the Track Record Period, Whole Sun supplied frozen food to Oriole. Due to internal restructuring of the companies held by Mr. Chu Cho Wing, starting from January 1, 2018, Oriole International has replaced Oriole as the entity for purchase of frozen food from Whole Sun. Although Oriole has ceased to place purchase order with Whole Sun since January 1, 2018, there will still be certain transactions taking place between Oriole and Whole Sun during the year ending December 31, 2018 in relation to settlement of the purchase orders placed by Oriole with Whole Sun prior to January 1, 2018 and related storage services. Our Directors estimate that the total amount for the above transactions between Whole Sun and Oriole for the year ending December 31, 2018 would not exceed HK\$1.0 million. Oriole and Whole Sun have entered into a frozen food supply agreement dated December 15, 2017 to govern these transactions. This agreement will expire on December 31, 2018, as it is expected that there will be transactions taking place between Whole Sun and Oriole International only starting from January 1, 2019.

NON-FULLY EXEMPT CONTINUING CONNECTED TRANSACTIONS

Immediately following the Listing, we will have the following transactions with our connected person at the subsidiary level which are exempt from the circular, independent financial advice and Shareholders' approval requirements but subject to the reporting, annual review and announcement requirements under Rule 14A.101 of the Listing Rules.

Supply of frozen food to Oriole and Oriole International
(a) Background and the principal terms of the Frozen Food Supply Agreement

Whole Sun has entered into a frozen food supply agreement (the "**Frozen Food Supply Agreement**") with Oriole International dated December 15, 2017. Oriole International is principally engaged in trading of chilled and frozen food.

Pursuant to the Frozen Food Supply Agreement, Whole Sun has agreed to supply frozen food including meat and seafoods to Oriole International. The Frozen Food Supply Agreement is for a period of three years commencing from January 1, 2018. There is no minimum purchase amount stipulated in the Frozen Food Supply Agreement nor are we bound to supply frozen food to Oriole International. The purchase quantity and the purchase prices shall be specified in individual purchase order to be placed by Oriole International.

(b) Historical transaction amounts

The amount of sales of frozen food by Whole Sun to Oriole during the Track Record Period is set forth as follows:

	Year ended December 31,		
	2015	2016	2017
Amount of sales by			
Whole Sun to Oriole	HK\$25,644,000	HK\$28,986,000	HK\$37,455,000

As we have started to sell frozen food to Oriole International, instead of Oriole, since January 1, 2018, the historical sales figures to Oriole above are for illustration purpose only.

CONTINUING CONNECTED TRANSACTIONS

During the Track Record Period, there has been a steady increase in the demand of frozen food from Oriole and we have established a long-standing supplier-customer relationship with Oriole for over four years. Our Directors consider that it would be in the interests of our Group to continue our business with Oriole International after the Listing.

(c) Pricing policy

The prices of the sales of frozen food to Oriole International will be determined based on a cost plus basis, taking into account various factors, including the mark-up margin of comparable products sold to Whole Sun's independent customers, the prevailing market prices and the quality and the quantity of the frozen food ordered. Whole Sun adopts such pricing policy for transactions with its independent customers as well as Oriole International.

(d) Listing Rules implications

Oriole is wholly-owned by Mr. Chu Cho Wing, the son of Mr. Chu. Mr. Chu is a director and substantial shareholder of Whole Sun, which is our non-wholly-owned subsidiary. Therefore, Oriole is a connected person of our Company at the subsidiary level because Oriole is an associate of Mr. Chu.

Oriole International is owned as to 51% by Mr. Chu Cho Wing and as to 49% by Ms. Li Sze Mun Charmaine, the daughter-in-law of Mr. Chu. Mr. Chu is a director and substantial shareholder of Whole Sun, which is our non-wholly-owned subsidiary. Therefore, Oriole International is a connected person of our Company at the subsidiary level because Oriole International is an associate of Mr. Chu.

Our Board (including all the independent non-executive Directors) has approved the Frozen Food Supply Agreement and the transactions contemplated thereunder and all the independent non-executive Directors have confirmed that the terms of the Frozen Food Supply Agreement are fair and reasonable, on normal commercial terms or better and in the interests of our Company and our Shareholders as a whole. As such, pursuant to Rule 14A.101 of the Listing Rules, the transactions contemplated under the Frozen Food Supply Agreement are exempt from the circular, independent financial advice and Shareholders' approval requirements but are subject to the reporting, annual review and announcement requirements under Chapter 14A of the Listing Rules.

Application for waiver for non-fully exempt continuing connected transactions

As (i) the non-fully exempt continuing connected transactions will continue after the Listing on a recurring basis; (ii) the details of the non-fully exempt continuing connected transactions have been fully disclosed in this prospectus for the information of potential investors; (iii) our Directors confirmed that the non-fully exempt continuing connected transactions have been and will be entered into in the ordinary and usual course of our Group's business, on normal commercial terms or better and are fair and reasonable and in

CONTINUING CONNECTED TRANSACTIONS

the interests of our Company and our Shareholders as a whole; and (iv) the proposed annual caps in respect of the non-fully exempt continuing connected transactions are fair and reasonable and are in the interests of our Company and our Shareholders as a whole, our Directors consider that strict compliance with the announcement requirement under the Listing Rules would be burdensome and add unnecessary administrative costs on our Group. Accordingly, pursuant to Rule 14A.105 of the Listing Rules, we have applied for, and the Hong Kong Stock Exchange has granted to us, a waiver from strict compliance with the announcement requirement under Rule 14A.35 of the Listing Rules after the Listing in respect of the non-fully exempt continuing connected transactions, subject to the condition that the annual transaction value for each financial year not exceeding the relevant proposed annual caps as stated below:

Financial year	Proposed annual cap
Year ending December 31, 2018	HK\$41,500,000
Year ending December 31, 2019	HK\$45,300,000
Year ending December 31, 2020	HK\$49,000,000

In determining the proposed annual caps, our Company has taken into account (i) the historical levels of purchase by Oriole with a growth rate of approximately 13.0% to 29.2% during the Track Record Period; (ii) the expected increase in demand for frozen food from Oriole International during the three years ending December 31, 2020 with reference to the historical growth rates; and (iii) the estimated increase in the price levels of frozen food due to inflation.

Confirmation from our Directors

Our Directors, including the independent non-executive Directors, are of the opinion that (i) the non-fully exempt continuing connected transactions described above have been and shall be entered into in our ordinary and usual course of business, on normal commercial terms or better and are fair and reasonable and are in the interests of our Company and our Shareholders as a whole; and (ii) the proposed annual caps under the Frozen Food Supply Agreement are fair and reasonable and are in the interests of our Company and our Shareholders as a whole.

Confirmation from the Joint Sponsors

Based on the review of the Frozen Food Supply Agreement, the information provided by our Company in relation thereto and the discussions with the management of our Company, the Joint Sponsors are of the view that (i) the transactions contemplated under the Frozen Food Supply Agreement, for which the waiver is sought, have been and shall be entered into in the ordinary and usual course of business of our Group, on normal commercial terms or better and are fair and reasonable and in the interests of our Company and our Shareholders as a whole; and (ii) the proposed annual caps in relation thereto are fair and reasonable and in the interests of our Company and our Shareholders as a whole.

CONTINUING CONNECTED TRANSACTIONS

FULLY EXEMPT CONTINUING CONNECTED TRANSACTIONS

The continuing connected transactions below are exempt from the reporting, annual review, announcement, circular and independent Shareholders' approval requirements pursuant to Rule 14A.76(1) of the Listing Rules.

Lease of residential premises***(a) Background and the principal terms of the Lease Agreement***

Our Company has entered into a lease agreement (the "**Lease Agreement**") with Telenice dated December 15, 2017 for lease of a residential premises located at House H3, Belleview Place, 93 Repulse Bay Road, Hong Kong. Telenice is held as to approximately 50.0% and 50.0% by Mr. Wong and Ms. Li, the spouse of Mr. Wong, respectively. Telenice is a connected person of our Company because it is an associate of Mr. Wong, who is our executive Director, chief executive officer and Controlling Shareholder. The residential premises are used as Mr. Wong's corporate housing as part of his remuneration package.

Pursuant to the Lease Agreement, our Company has agreed to lease the residential premises from Telenice for a term of three years commencing from January 1, 2018 for a monthly rental of HK\$155,000, which is subject to annual review by both parties to ensure the monthly rental is in line with the prevailing market rent.

(b) Historical transaction amounts

The amount of rental inclusive of management fees, rates and fixtures paid by our Company to Telenice during the Track Record Period is set forth as follows:

	Year ended December 31,		
	2015	2016	2017
Amount of rental paid by our Company	HK\$1,920,000	HK\$1,860,000	HK\$1,860,000

(c) Determination of rental

The monthly rental was determined with reference to the prevailing market rent of the surrounding comparable residential premises, as confirmed by an independent valuation conducted by JLL.

Our Directors consider that the Lease Agreement is entered in the ordinary and usual course of our business, on normal commercial terms or better and is fair and reasonable and is in the interests of our Company and our Shareholders as a whole.

CONTINUING CONNECTED TRANSACTIONS

Purchase of ice-cream from GZDD***(a) Background and the principal terms of the Ice-cream Supply Agreement***

SHTW and DGTW have entered into an ice-cream supply agreement (the “**Ice-cream Supply Agreement**”) with GZDD dated December 15, 2017. GZDD is principally engaged in manufacturing and wholesale of ice-cream in the PRC and is held as to 80% by Mr. Wong through Elect Gold and 20% by Super Active Profits Limited, an Independent Third Party. GZDD is a connected person of our Company because it is an associate of Mr. Wong, who is our executive Director, chief executive officer and Controlling Shareholder.

Pursuant to the Ice-cream Supply Agreement, GZDD has agreed to supply ice-cream to SHTW and DGTW. The Ice-cream Supply Agreement is for a period of three years commencing from January 1, 2018. There is no minimum purchase amount stipulated in the Ice-cream Supply Agreement nor are we bound to purchase ice-cream from GZDD. The purchase quantity and purchase prices shall be specified in individual purchase order to be placed by SHTW and DGTW.

(b) Historical transaction amounts

The amount of purchase of ice-cream by our Group from GZDD during the Track Record Period is set forth as follows:

	Year ended December 31,		
	2015	2016	2017
Amount of purchase by our Group from GZDD	N/A	HK\$606,000 ^(Note)	HK\$920,000

Note: The transaction amounts during the year ended December 31, 2016 relate to the transactions which took place from June 1, 2016 onwards as GZDD had been a subsidiary of our Group prior to our disposal of the ice-cream business, which was completed on May 31, 2016. Further information is set forth in the section headed “History, Development and Corporate Structure — History and Business Development — Material Development after Delisting — (b) Incorporation, Acquisitions and Disposal of Elect Gold” in this prospectus.

(c) Pricing policy

Pursuant to the Ice-cream Supply Agreement, the price of the ice-cream shall be determined based on a cost plus basis, taking into account various factors, including the mark-up margin of comparable products sold to GZDD’s independent customers, the prevailing market prices and the quality and the quantity of the ice-cream ordered.

Our Directors consider that the Ice-cream Supply Agreement is entered in the ordinary and usual course of our business, on normal commercial terms or better, and is fair and reasonable and is in the interests of our Company and our Shareholders as a whole.

CONTINUING CONNECTED TRANSACTIONS

Supply of beverage products to GZDD and DD(GZ)CC***(a) Background and the principal terms of the Beverage Products Supply Agreement***

SHTW has entered into a beverage products supply agreement (the “**Beverage Products Supply Agreement**”) with GZDD and DD(GZ)CC dated December 15, 2017. Each of GZDD and DD(GZ)CC is held as to 80% by Mr. Wong through Elect Gold and 20% by Super Active Profits Limited, an Independent Third Party. GZDD is principally engaged in manufacturing and wholesale of ice-cream in the PRC and DD(GZ)CC is principally engaged in the retail sales of ice-cream in the PRC. GZDD and DD(GZ)CC are the connected persons of our Company because they are the associates of Mr. Wong, who is our executive Director, chief executive officer and Controlling Shareholder.

Pursuant to the Beverage Products Supply Agreement, SHTW has agreed to supply beverage products including tea bags, coffee powder, sugar, syrup and milk to GZDD and DD(GZ)CC. The Beverage Products Supply Agreement is for a period of three years commencing from January 1, 2018. There is no minimum purchase amount stipulated in the Beverage Products Supply Agreement nor are we bound to supply beverage products to GZDD and DD(GZ)CC. The purchase quantity shall be specified in individual purchase order to be placed by GZDD and DD(GZ)CC whereas the purchase price shall follow the price list issued and maintained by SHTW from time to time.

(b) Historical transaction amounts

The amount of sales of beverage products by SHTW to GZDD and DD(GZ)CC during the Track Record Period is set forth as follows:

	Year ended December 31,		
	2015	2016	2017
Amount of sales by SHTW to GZDD and DD(GZ)CC	N/A	HK\$13,000 ^(Note)	HK\$15,000

Note: The transaction amounts during the year ended December 31, 2016 relate to the transactions which took place from June 1, 2016 to December 31, 2016 as GZDD and DD(GZ)CC had been subsidiaries of our Group prior to the disposal of the ice-cream business which was completed on May 31, 2016. Further information is set forth in the section headed “History, Development and Corporate Structure — History and Business Development — Material Development after Delisting — (b) Incorporation, Acquisitions and Disposal of Elect Gold” in this prospectus.

(c) Pricing policy

Pursuant to the Beverage Products Supply Agreement, the price of the beverage products shall follow the price list issued and maintained by SHTW from time to time. The price list sets out the unit price for different types of beverage products. The price list is prepared with reference to the prevailing market prices of similar products. We regularly review the price lists to ensure the prices in the price list would achieve reasonable profit margin. SHTW adopts such price list for transactions with its independent customers as well as with GZDD and DD(GZ)CC. In the event that the beverage products sold are not

CONTINUING CONNECTED TRANSACTIONS

covered in the price list, the price of such beverage products shall be determined based on a cost plus basis, taking into account various factors, including the mark-up margin of comparable products sold to SHTW's independent customers (if applicable), the prevailing market prices and the quality and the quantity of the beverage products ordered.

Our Directors consider that the Beverage Products Supply Agreement is entered into in the ordinary and usual course of our business, the terms of which offered by SHTW to GZDD and DD(GZ)CC are fair and reasonable and no more favourable than those offered by SHTW to its independent customers and in the interests of our Company and our Shareholders as a whole.

Implications under the Listing Rules

Each of Telenice, GZDD and DD(GZ)CC is an associate of Mr. Wong, who is our executive Director, chief executive officer and Controlling Shareholder, and therefore is the connected person of our Company pursuant to Rule 14A.12(1)(c) of the Listing Rules.

Given each of the applicable percentage ratios (other than profits ratio), as defined under the Listing Rules, in respect of each of the Lease Agreement, the Ice-cream Supply Agreement and the Beverage Products Supply Agreement is expected to be less than 5% on an annual basis and the total annual consideration is less than HK\$3.0 million for each of the three years ending December 31, 2020, each of these transactions constitutes a de minimis transaction under Rule 14A.76(1) of the Listing Rules and is exempt from the reporting, announcement, annual review, circular and independent Shareholders' approval requirements under Chapter 14A of the Listing Rules.

CORNERSTONE INVESTORS

THE CORNERSTONE PLACING

We have entered into cornerstone investment agreements with NH Foods and F&N as investors (the “**Cornerstone Investors**”, each a “**Cornerstone Investor**”), pursuant to which NH Foods has agreed to subscribe at the Offer Price for such number of Offer Shares (rounded down to the nearest whole board lot of 2,000 Shares) that may be purchased for an aggregate amount of one billion Japanese Yen (equivalent to approximately HK\$72.9 million based on the indicative exchange rate of one Japanese Yen to HK\$0.0729 as of the Latest Practicable Date) and F&N has agreed to subscribe for a fixed number of 32,000,000 Shares at the Offer Price, representing approximately 4.42% of our total issued Shares immediately following the completion of the Global Offering (without taking into account any Shares which may be allotted and issued upon the exercise of the Over-allotment Option and the options which have been granted under the Pre-IPO Share Option Scheme or which may be granted under the Share Option Scheme). Based on the mid-point of the Offer Price range of HK\$1.84, the total number of Shares to be subscribed for by the Cornerstone Investors will be 71,618,000 Shares, representing (i) approximately 29.94% of the Offer Shares, and approximately 9.89% of our total issued Shares, upon completion of the Global Offering (assuming that the Over-allotment Option is not exercised and without taking into account any Shares which may be allotted and issued upon the exercise of the options which have been granted under the Pre-IPO Share Option Scheme or which may be granted under the Share Option Scheme); and (ii) approximately 26.03% of the Offer Shares, and approximately 9.42% of our total issued Shares, upon completion of the Global Offering (assuming that the Over-allotment Option is exercised in full and without taking into account any Shares which may be allotted and issued upon the exercise of the options which have been granted under the Pre-IPO Share Option Scheme or which may be granted under the Share Option Scheme). Under the respective cornerstone investment agreements, each Cornerstone Investor may elect to acquire the Shares through one of its wholly-owned subsidiaries.

To the best knowledge of our Company, each of the Cornerstone Investors are independent from our Company, our connected persons and their respective associates. The Cornerstone Investors will not subscribe for any Shares under the Global Offering other than pursuant to the cornerstone investment agreements. Immediately following the completion of the Global Offering, the Cornerstone Investors will not have any board representation in our Company, nor will any Cornerstone Investor become a substantial Shareholder of our Company. The shareholdings of the Cornerstone Investors will be counted towards the public float of our Shares.

The cornerstone placing forms part of the International Offering. In the event that the requirement pursuant to Rule 8.08(3) of the Listing Rules, which provides that no more than 50% of the Shares in public hands on the Listing Date can be beneficially owned by the three largest public Shareholders, cannot be satisfied, the Sole Global Coordinator, after consulting with and obtaining the consent from our Company, has the right to adjust the allocation of the number of Shares to be purchased by each of the Cornerstone Investors in its sole and absolute discretion to satisfy the requirement pursuant to Rule 8.08(3) of the Listing Rules. Notwithstanding the aforesaid, the percentage of the shareholding of NH Foods in our Company shall be not less than 3% of our entire issued share capital upon

CORNERSTONE INVESTORS

completion of the Global Offering (excluding any Shares to be issued and allotted pursuant to the exercise of the Over-allotment Option and the options which have been granted under the Pre-IPO Share Option Scheme or which may be granted under the Share Option Scheme). The Shares to be purchased by the Cornerstone Investors will not be affected by any reallocation of the Shares between the International Offering and the Hong Kong Public Offering in the event of over-subscription under the Hong Kong Public Offering as described in the section headed “Structure of the Global Offering — The Hong Kong Public Offering” in this prospectus. Details of the allocations to the Cornerstone Investors will be disclosed in the announcement of, among others, results of application and basis of allotment of the Hong Kong Offer Shares to be published on or around Thursday, May 10, 2018.

CORNERSTONE INVESTORS

We have entered into cornerstone investment agreements with each of the following Cornerstone Investors:

Cornerstone Investor	Investment Amount	Approximate percentage of the Offer Shares and the Shares in issue immediately following the completion of the Global Offering (assuming the Over-allotment is not exercised and without taking into account any Shares which may be allotted and issued upon the exercise of the options which have been granted under the Pre-IPO Share Option Scheme or which may be granted under the Share Option Scheme)	Approximate percentage of the Offer Shares and the Shares in issue immediately following the completion of the Global Offering (assuming that the Over-allotment Option is exercised in full and without taking into account any Shares which may be allotted and issued upon the exercise of the options which have been granted under the Pre-IPO Share Option Scheme or which may be granted under the Share Option Scheme)
NH Foods	One billion Japanese Yen <i>(Note 1)</i>	16.56% of the Offer Shares and 5.47% of our total issued Shares <i>(Note 2)</i>	14.40% of the Offer Shares and 5.21% of our total issued Shares <i>(Note 2)</i>
F&N	58.88 million Hong Kong Dollars <i>(Note 3)</i>	13.38% of the Offer Shares and 4.42% of our total issued Shares	11.63% of the Offer Shares and 4.21% of our total issued Shares

Note 1: The exact number of Shares to be subscribed by NH Foods will be subject to the fluctuation in the exchange rate of Japanese Yen to Hong Kong dollars.

Note 2: The shareholding percentage is calculated based on the mid-point of the Offer Price range of HK\$1.84 and the indicative exchange rate of one Japanese Yen to HK\$0.0729 as of the Latest Practicable Date for illustrative purpose.

Note 3: The investment amount is calculated based on the mid-point of the Offer Price range of HK\$1.84 times the 32,000,000 Shares to be subscribed by F&N for illustrative purpose.

CORNERSTONE INVESTORS

The information about our Cornerstone Investors set forth below has been provided by the Cornerstone Investors:

NH Foods

NH Foods is a Japanese corporation listed on the Tokyo Stock Exchange, Inc., with operations in fresh meat, ham, sausage and processed foods industries. Our Company has entered into a strategic cooperation agreement with NH Foods in July 2017. For details, please refer to the section headed “History, Development and Corporate Structure — Material Development after Delisting — (g) Entering into strategic cooperation agreement with NH Foods” in this prospectus.

F&N

F&N is a limited liability company incorporated under the laws of Singapore in 1898 and is currently listed on the SGX-ST. The F&N group is principally engaged in the production and sale of beverages and dairy products and publishing and printing.

Our Company has entered into a memorandum of understanding with F&N in April 2018. For details, please refer to the section headed “History, Development and Corporate Structure — History and Business Development — Material Development after Delisting — (h) Entering into Memorandum of Understanding with F&N” in this prospectus.

RESTRICTIONS ON DISPOSALS BY CORNERSTONE INVESTORS

Each of the Cornerstone Investors has agreed that it will not, whether directly or indirectly, at any time during the lock-up period of six months starting from and inclusive of the Listing Date, dispose of any of the Shares subscribed for by it pursuant to the respective cornerstone investment agreement, other than transfers to its wholly-owned subsidiary provided that such wholly-owned subsidiary undertakes to, and each of them undertakes to procure that such wholly-owned subsidiary will, abide by the restrictions on disposals imposed on it.

CONDITIONS PRECEDENT

The subscription obligation of the Cornerstone Investors is subject to, among other things, the following conditions precedent:

- (i) the Hong Kong Underwriting Agreement and the International Underwriting Agreement having been entered into, become effective and having become unconditional (in accordance with their respective original terms, or as subsequently varied by agreement of the parties thereto or waived, to the extent it may be waived, by the relevant parties) by no later than the time and date as specified in the Underwriting Agreements;
- (ii) neither of the Underwriting Agreements having been terminated or having lapsed in accordance with their terms and conditions;

CORNERSTONE INVESTORS

- (iii) no laws having been enacted or promulgated by any governmental authority which prohibit the consummation of the transactions contemplated in the Hong Kong Public Offering, the International Offering or the respective cornerstone investment agreement and there being no orders or injunctions from a court of competent jurisdiction in effect precluding or prohibiting consummation of such transactions;
- (iv) the Listing Committee of the Hong Kong Stock Exchange having granted approval for the listing of, and permission to deal in, the Shares and such approval or permission not having been revoked;
- (v) the Offer Price having been agreed by the Sole Global Coordinator (for itself and on behalf of the Underwriters) and our Company (for itself and on behalf of the Selling Shareholder) in connection with the Global Offering;
- (vi) the respective representations, warranties, undertakings, acknowledgements and confirmations of the Cornerstone Investors and our Company in the cornerstone investment agreements being accurate and true in all material aspects and not misleading and there being no material breach of the cornerstone investment agreements on the part of the Cornerstone Investors; and
- (vii) the Offer Price per Share being not more than HK\$2.783 per Share (in the case of NH Foods) and HK\$2.19 per Share (in the case of F&N). In any event, the Share price paid by the Cornerstone Investors must not be higher than that offered to the other investors of the Global Offering.

SHARE CAPITAL

SHARE CAPITAL

The authorized share capital of our Company is as follows:

Authorized share capital

	<i>HK\$</i>
<u>2,000,000,000</u> Shares	<u>200,000,000</u>

The issued share capital of our Company immediately following completion of the Global Offering (without taking into account any Shares which may be allotted and issued upon the exercise of the Over-allotment Option and the options which have been granted under the Pre-IPO Share Option Scheme or which may be granted under the Share Option Scheme) will be as follows:

Shares in issue or to be issued, fully paid or credited as fully paid

	<i>HK\$</i>
617,750,000 Shares in issue as of the Latest Practicable Date	61,775,000.0
<u>106,229,312</u> Shares to be allotted and issued pursuant to the Global Offering	<u>10,622,931.2</u>
<u>723,979,312</u>	<u>72,397,931.2</u>

MINIMUM PUBLIC FLOAT

At least 25% of the total number of issued Shares must at all times be held by the public. The 239,200,000 Offer Shares represent approximately 33.04% of the issued share capital of our Company upon the Listing (without taking into account any Shares which may be allotted and issued upon the exercise of the Over-allotment Option and the options which have been granted under the Pre-IPO Share Option Scheme or which may be granted under the Share Option Scheme).

RANKING

The Offer Shares will rank *pari passu* in all respects with all Shares in issue or to be issued and will qualify for all dividends or other distributions declared, made or paid after the date of this prospectus.

SHARE CAPITAL

GENERAL MANDATE TO ISSUE SHARES

Subject to the Global Offering becoming unconditional, our Directors have been granted a general unconditional mandate to allot and issue and deal with the unissued Shares with an aggregate nominal value of not more than the sum of:

- (a) 20% of the number of Shares in issue immediately following completion of the Global Offering (without taking into account any Shares which may be allotted and issued upon the exercise of the Over-allotment Option and the options which have been granted under the Pre-IPO Share Option Scheme or which may be granted under the Share Option Scheme); and
- (b) the number of Shares repurchased by our Company (if any) pursuant to the general mandate to repurchase Shares as described below.

Our Directors may, in addition to the Shares which they are authorized to issue under the mandate, allot, issue and deal in the Shares pursuant to a rights issue, an issue of Shares pursuant to the exercise of subscription rights attaching to any warrant of our Company, scrip dividends or similar arrangements providing for the allotment of Shares in lieu of the whole or in part of any cash dividend or option to be granted under the Share Option Scheme or any other option scheme or similar arrangement for the time being adopted or such other issue and allotment of Shares or securities of our Company as permitted under the Listing Rules.

For further details of this general mandate, please refer to the section headed “A. Further information about our Group — 4. Written resolutions of the sole Shareholder” in Appendix IV to this prospectus.

GENERAL MANDATE TO REPURCHASE SHARES

Subject to the Global Offering becoming unconditional, our Directors have been granted a general unconditional mandate to exercise all the powers of our Company to repurchase Shares with a total nominal value of not more than 10% of the aggregate nominal value of the Shares in issue immediately following completion of the Global Offering (without taking into account any Shares which may be allotted and issued upon the exercise of the Over-allotment Option and the options which have been granted under the Pre-IPO Share Option Scheme or which may be granted under the Share Option Scheme).

This mandate only relates to repurchases made on the Hong Kong Stock Exchange, or on any other stock exchange on which the Shares are listed (and which is recognised by the SFC and the Hong Kong Stock Exchange for this purpose), and which are in accordance with all applicable laws and the requirements of the Listing Rules or of any other stock exchange on which the Shares are listed as amended from time to time. For further details of this general mandate, please refer to the section headed “A. Further information about our Group — 6. Repurchase of our Company’s own securities” in Appendix IV to this prospectus.

SHARE CAPITAL

The general mandate to issue Shares and repurchase Shares will respectively expire:

- (a) at the conclusion of the next annual general meeting of our Company;
- (b) at the expiration of the period within which the next annual general meeting of our Company is required by the Companies Act, any applicable law of Bermuda or the Bye-Laws to be held; or
- (c) when varied, revoked or renewed by an ordinary resolution of the Shareholders in general meeting,

whichever is the earliest.

SHARE OPTION SCHEMES

Our Company has conditionally adopted the Pre-IPO Share Option and the Share Option Scheme. A summary of their respective principal terms is set out in the section headed “D. Share Option Schemes” in Appendix IV to this prospectus.

CIRCUMSTANCES UNDER WHICH GENERAL MEETING AND CLASS MEETING ARE REQUIRED

Under the Companies Act and pursuant to the Bye-Laws, our Company may from time to time by ordinary resolution: (i) increase its share capital by the creation of new shares; (ii) consolidate all or any of its share capital into shares of larger amount than its existing shares; (iii) divide its shares into several classes and attach to such shares any preferential, deferred, qualified or special rights, privileges or conditions; (iv) sub-divide its shares or any of them into shares of smaller amount than is fixed by the Memorandum; (v) cancel any shares which at the date of the resolution have not been taken or agreed to be taken by any person, and diminish the amount of its share capital by the amount of the shares so cancelled; (vi) make provision for the issue and allotment of shares which do not carry any voting rights; and (vii) change the currency denomination of its share capital. In addition, our Company may by special resolution reduce its share capital, any capital redemption reserve fund or any share premium account in any manner authorized and subject to any conditions prescribed by law.

Subject to the Companies Act and pursuant to the Bye-Laws, if at any time the capital is divided into different classes of shares, all or any of the special rights attached to any class (unless otherwise provided for by the terms of issue of that class) may be varied or abrogated either with the consent in writing of the holders of not less than three-fourths in nominal value of the issued shares of that class or with the sanction of a special resolution passed at a separate general meeting of the holders of the shares of that class. For details, please refer to the paragraph headed “Summary of the Constitution of our Company and Bermuda Company Law — 2. Bye-Laws — (2)(a)(iii)” in Appendix III to this prospectus.

SUBSTANTIAL SHAREHOLDERS

SUBSTANTIAL SHAREHOLDERS

So far as our Directors are aware, the following persons will, immediately prior to and following the completion of the Global Offering (without taking into account any Shares which may be allotted and issued upon the exercise of the Over-allotment Option and the options which have been granted under the Pre-IPO Share Option Scheme or which may be granted under the Share Option Scheme), have interests or short positions in our Shares or underlying Shares which would be required to be disclosed to us under the provisions of Divisions 2 and 3 of Part XV of the SFO, or are, directly or indirectly, interested in 10% or more of the nominal value of any class of share capital carrying rights to vote in all circumstances at general meetings of our Company:

Name	Nature of interests	Shares held immediately prior to the completion of the Global Offering ⁽¹⁾		Shares held immediately following the completion of the Global Offering	
		Class and number of securities held ⁽¹⁾	Percentage of interest in our Company	Class and number of securities held ⁽¹⁾	Percentage of interest in our Company
Hero Valour ⁽²⁾	Beneficial interests	617,750,000 ordinary Shares (L)	100%	484,779,312 ordinary Shares (L)	66.96%
Mr. Wong	Interest of controlled corporation	617,750,000 ordinary Shares (L)	100%	484,779,312 ordinary Shares (L)	66.96%
Ms. Li Ying Wah Irene	Interest of spouse ⁽³⁾	617,750,000 ordinary Shares (L)	100%	484,779,312 ordinary Shares (L)	66.96%

Notes:

- (1) The letter “L” denotes the entity’s/person’s long position in the securities.
- (2) Our Company will be owned as to approximately 66.96% by Hero Valour immediately upon completion of the Global Offering. Hero Valour is 100% legally and beneficially owned by Mr. Wong. Under the SFO, Mr. Wong is deemed to be interested in the same number of Shares held by Hero Valour. Mr. Wong is the sole director of Hero Valour.
- (3) Ms. Li Ying Wah Irene is the spouse of Mr. Wong. Under the SFO, Ms. Li is deemed to be interested in the same number of Shares in which Mr. Wong is interested.

If the Over-allotment Option is fully exercised, the beneficial interests of Mr. Wong, through his shareholding in Hero Valour, in the issued share capital of our Company will be approximately 63.8% (without taking into account any Shares which may be allotted and issued upon the exercise of the options which have been granted under the Pre-IPO Share Option Scheme or which may be granted under the Share Option Scheme).

The substantial Shareholders, being persons who are entitled to exercise, or control the exercise of, 10% or more of the voting power at any general meeting of our Company, are Mr. Wong and Hero Valour.

SUBSTANTIAL SHAREHOLDERS

Except as disclosed above, our Directors are not aware of any other person who will, immediately following the completion of the Global Offering (without taking into account any Shares which may be allotted and issued upon the exercise of the Over-allotment Option and the options which have been granted under the Pre-IPO Share Option Scheme or which may be granted under the Share Option Scheme), have interests or short positions in any Shares or underlying Shares, which would be required to be disclosed to us under the provisions of Divisions 2 and 3 of Part XV of the SFO, or who is, directly or indirectly interested in 10% or more of the nominal value of any class of share capital carrying rights to vote in the circumstances at general meetings of our Company. As of the Latest Practicable Date, our Directors were not aware of any arrangement which may at a subsequent date result in a change of control of our Company.

DIRECTORS AND SENIOR MANAGEMENT

GENERAL

The following table sets forth certain information regarding our Directors and senior management:

Name	Age	Present position	Date of appointment as Director	Date of joining our Group	Roles and responsibilities	Relationship with other Director(s) and/or senior management
Directors						
Mr. Wong Tat Tong (黃達堂先生)	64	Executive Director, chairman of the Board, chief executive officer	July 6, 2000	May 1, 1978	managing and formulating overall strategic planning and development of our Group	None
Mr. Wu Kam On Keith (鄺錦安先生)	43	Executive Director, group chief operation officer, company secretary	January 22, 2010	July 25, 2005	assisting in strategic planning and business and corporate development of our Group	None
Ms. Fan Yee Man (樊綺敏小姐)	37	Executive Director, group chief financial officer	September 4, 2017	January 26, 2012	overseeing the overall financial position and accounting matters of our Group	None
Mr. Tang Kwai Chang (鄧貴彰先生)	65	Independent non-executive Director	December 15, 2017	Listing Date	supervising and providing independent judgment for the Board	None
Mr. Chow Alexander Yue Nong (周裕農先生)	67	Independent non-executive Director	December 15, 2017	Listing Date	supervising and providing independent judgment for the Board	None
Mr. Wong Man Fai (王文輝先生)	69	Independent non-executive Director	December 15, 2017	Listing Date	supervising and providing independent judgment for the Board	None
Name	Age	Present position	Date of joining our Group	Roles and responsibilities	Relationship with other Director(s) and/or senior management	
Senior management						
Mr. Hui Chi Ho (許志豪先生)	44	Operating officer of group marketing and sales	July 14, 2003	formulating and overseeing overall sales and marketing strategies and activities of our Group	None	
Mr. Leung Kim Ming (梁劍明先生)	52	Chief operating officer of China	August 20, 2008	formulating our Group's China production and project policies and strategies	None	
Mr. Kam Chun Pong Bernard (金振邦先生)	61	Group business director	June 1, 2007	executing our Group's sales and marketing strategies	None	
Mr. Chan Pei Shun (陳彼信先生)	51	Director of risk management and operation control	July 26, 2004	maintaining risk management and internal control system	None	
Ms. Law Wan Yee Sandy (羅韻儀小姐)	42	Internal audit manager	December 22, 2003	overseeing corporate governance and internal control matters	None	

DIRECTORS AND SENIOR MANAGEMENT

DIRECTORS

Upon Listing, our Board will consist of six Directors, comprising three executive Directors and three independent non-executive Directors. We have entered into service contracts with each of our executive Directors and letters of appointment with each of our independent non-executive Directors.

Executive Directors

Wong Tat Tong (黃達堂), aged 64, has been our Director since July 6, 2000 and was re-designated as an executive Director on September 4, 2017. He is the chairman of our Board, and was appointed as the chief executive officer of our Company on September 4, 2017. He is primarily responsible for managing and formulating overall strategic planning and development of our Group. Mr. Wong has joined our Group for over 39 years since May 1978, and has been appointed as a director of TWHK since June 11, 1979. Mr. Wong is also a director of the following subsidiaries of our Group: TWIC, TWCH, Great Guarder, TWHK, Whole Sun, TWFF, TWGM, COFE, CDEL, TWHKFF, TW Beverage Machine, TWCI, TWCE, TWCT, DGTW, HK TWG Heritage and TWCC.

Being responsible for the day-to-day management and overall strategic planning and development of our Group, Mr. Wong has been playing an important role in our development and growth over the past 39 years. Under Mr. Wong's leadership, our Group continued to grow progressively with a number of breakthroughs. For further details of our Group's business development, please refer to the section headed "History, Development and Corporate Structure" in this prospectus.

Mr. Wong received a diploma in accounting from the Hong Kong Baptist College (presently known as the Hong Kong Baptist University) in June 1976. He has been the Permanent Honorary President of the Hong Kong Foodstuffs Association since March 2000 and the Permanent Honorary President of The Hong Kong and Kowloon Provisions, Wine & Spirit Dealers' Association Limited since 2001. He has also been a member and a director of the committee of The Chinese General Chamber of Commerce since 1994. Further, Mr. Wong has been the representative of COFE's membership in The Hong Kong Chinese Importers' and Exporters' Association since December 1990.

DIRECTORS AND SENIOR MANAGEMENT

Mr. Wong was a director of the following companies which were incorporated in Hong Kong and dissolved by (i) deregistration by the Registrar of Companies of Hong Kong pursuant to section 291AA of the Predecessor Companies Ordinance or section 751 of the Companies Ordinance (as the case may be); or (ii) striking off by the Registrar of Companies of Hong Kong pursuant to section 291 of the Predecessor Companies Ordinance and the relevant details are as follows:

Name of the company	Nature of business prior to dissolution	Date of dissolution	Nature of proceeding
Full Hero International Limited (輝康國際有限公司)	No business operation <i>(Note 1 and 3)</i>	January 6, 2017	Deregistration
TMS Holdings Limited	No business operation <i>(Note 1 and 3)</i>	December 7, 2012	Deregistration
Venture Well Enterprises Limited (通捷企業有限公司)	No business operation <i>(Note 1 and 3)</i>	May 4, 2012	Deregistration
Star Bucks Company Limited	No business operation <i>(Note 2 and Note 3)</i>	October 19, 2001	Striking off

Note 1: Under section 291AA of the Predecessor Companies Ordinance or section 750 of the Companies Ordinance, an application for deregistration can only be made if (a) all members of such company agree to such deregistration; (b) such company has never commenced business or operation, or has ceased to carry on business or ceased operation for more than three months immediately before the application; and (c) such company has no outstanding liabilities.

Note 2: Under section 291 of the Predecessor Companies Ordinance, a company will be struck off if the Registrar of Companies of Hong Kong has reasonable cause to believe that a company is not carrying on business or in operation.

Note 3: As confirmed by Mr. Wong, each of the companies aforementioned in this paragraph was inactive and was solvent at the time of dissolution or being struck off. Mr. Wong further confirmed that there was no wrongful act on his part leading to the dissolution or striking off and he is not aware of any actual or potential claim that has been or will be made against him as a result of such dissolution or striking off.

Wu Kam On Keith (鄔錦安), aged 43, has been our Director since January 22, 2010 and was re-designated as an executive Director on September 4, 2017. He was appointed as the group chief operation officer and company secretary of our Company on September 4, 2017 and August 18, 2017, respectively. Mr. Wu is primarily responsible for assisting in strategic planning and business and corporate development of our Group. Mr. Wu has joined our Group for 12 years since July 2005 as a management accountant and had held various positions within our Group. He was the management accountant from July 2005 to March 2006, the assistant financial controller from April 2006 to January 2010, the group financial controller and group general manager from January 2010 to December 2015 and the group chief financial officer from January 2016 to September 2017. Mr. Wu is the director of the following subsidiaries of our Group: TWCH, TWHK, Whole Sun, COFE, CDEL,

DIRECTORS AND SENIOR MANAGEMENT

TWHKFF, TW Beverage Machine, TWCE, TWCT, DGTW, HK TWG Heritage, DG TWG Heritage and TWCC. He is also the company secretary of all of our subsidiaries incorporated in Hong Kong.

Mr. Wu has 20 years of experience in finance and accounting management. Prior to joining our Group, Mr. Wu worked at Kwan Wong Tan & Fong as Accountant II in the audit department from June 1997 to August 1997 and following a merger, worked at Deloitte Touche Tohmatsu with his last position as a semi-senior accountant from August 1997 to July 2000, during which he was primarily responsible for handling small to medium-sized audit assignments. He also served Hongkong International Terminals Limited from April 2001 to June 2004, with his last position as accountant I in the finance and administration department.

Mr. Wu received a bachelor of arts (honours) in accountancy from the City University of Hong Kong in November 1997 and a degree of master of corporate governance from the Hong Kong Polytechnic University in October 2009. Mr. Wu was admitted as a fellow and accredited as an authorized supervisor of Hong Kong Institute of Certified Public Accountants in September 2008 and July 2012, respectively. He was admitted as a fellow and registered as a certified tax advisor of The Taxation Institute of Hong Kong in July 2010 and August 2010, respectively. He was also admitted as an associate of The Hong Kong Institute of Chartered Secretaries in April 2010 and elected as an associate of The Institute of Chartered Secretaries and Administrators in the United Kingdom in April 2010. Mr. Wu is also a member of the executive committee of Group 8 (food, beverages and tobacco) of Federation of Hong Kong Industries for a term from July 2015 to July 2019.

Mr. Wu has been appointed as an independent non-executive director of Fulum Group Holdings Limited (stock code: 1443), a restaurant chain serving Chinese cuisine, since October 28, 2014, Hao Bai International (Cayman) Limited (stock code: 8431), a Hong Kong-based contractor specialized in design, procurement and installation services of the water circulation systems, since January 19, 2017 and Sanbase Corporation Limited (stock code: 8501), an interior fit-out solutions provider focusing on providing services to clients whose offices are predominately situated in Grade A offices in Hong Kong, since December 8, 2017.

DIRECTORS AND SENIOR MANAGEMENT

Mr. Wu was a director of the following company which was incorporated in Hong Kong and dissolved by deregistration by the Registrar of Companies of Hong Kong pursuant to section 291AA of the Predecessor Companies Ordinance and the relevant details are as follows:

Name of the company	Nature of business prior to dissolution	Date of dissolution	Nature of proceeding
TMS Holdings Limited	No business operation <i>(Note 1 and 2)</i>	December 7, 2012	Deregistration

Note 1: Under section 291AA of the Predecessor Companies Ordinance, an application for deregistration can only be made if (a) all members of such company agree to such deregistration; (b) such company has never commenced business or operation, or has ceased to carry on business or ceased operation for more than three months immediately before the application; and (c) such company has no outstanding liabilities.

Note 2: As confirmed by Mr. Wu, the company aforementioned in this paragraph had no business operations and was solvent at the time of dissolution. Mr. Wu further confirmed that there was no wrongful act on his part leading to the dissolution and he is not aware of any actual or potential claim that has been or will be made against him as a result of such dissolution.

Fan Yee Man (樊綺敏), aged 37, was appointed as an executive Director on September 4, 2017. Ms. Fan was appointed as the group chief financial officer of our Company on September 4, 2017. She is primarily responsible for overseeing the overall financial position and accounting matters of our Group. Ms. Fan has joined our Group for six years since January 2012 as the financial controller. She was the financial controller from January 2012 to December 2015 and the group financial controller from January 2016 to September 4, 2017. Ms. Fan is the director of COFE, Global Tea Trading and TWCT.

Ms. Fan has 14 years of experience in finance and accounting management. Prior to joining our Group, Ms. Fan served Ho, Sneddon, Chow Certified Public Accountants Limited as staff auditor from May 2003 to July 2004, as well as BDO McCabe Lo & Co (presently known as BDO Limited) as associate in the audit department from July 2004 to July 2005. From July 2005 to January 2012, she worked at Deloitte Touche Tohmatsu, with her last position as manager.

Ms. Fan received a bachelor of business administration (honours) in accountancy from the City University of Hong Kong in November 2003. Ms. Fan was admitted as a member and a fellow of The Association of Chartered Certified Accountants in December 2007 and December 2012, respectively. Ms. Fan was certified as Certified Public Accountant by the Hong Kong Institute of Certified Public Accountants in September 2010.

DIRECTORS AND SENIOR MANAGEMENT

Independent non-executive Directors

Tang Kwai Chang (鄧貴彰), aged 65, was appointed as an independent non-executive Director on December 15, 2017. Mr. Tang is primarily responsible for supervising and providing independent judgment for the Board.

Mr. Tang has over 40 years of experience in accounting, auditing and audit risk management. He joined Deloitte Haskins & Sells (presently known as Deloitte Touche Tohmatsu) (“**Deloitte**”) in August 1976 as an audit trainee, and then left as a senior accountant in July 1980. He then joined GPI (Holdings) Limited (presently known as Gold Peak Industries (Holdings) Limited) (stock code: 40), a company engaging in industrial investment, as an assistant finance manager, in August 1980. He rejoined Deloitte as a senior accountant in the audit department in January 1982 and became a partner in April 1988. Mr. Tang was the vice chairman of Deloitte China from July 2011 to May 2013 and a member of the board of Deloitte Global from August 2011 to May 2013. During his around 35 years at Deloitte, Mr. Tang was responsible for providing audit and audit related services and undertaking governance and management roles.

Mr. Tang has been appointed as an independent non-executive director of HKR International Limited (stock code: 480), a company engaging in property development and investment, since September 24, 2014 and FIT Hon Teng Limited (stock code: 6088), a company engaging in the development and production of interconnect solutions and related products, since November 4, 2016.

Mr. Tang has also been a director of (i) Baosteel Resources Company Limited* (寶鋼資源有限公司), a company mainly dealing with the investment, trade and logistics services of mineral resources, since July 21, 2016; (ii) Baosteel Resources International Company Limited, a company mainly dealing with the investment, trade and logistics services of mineral resources, since August 16, 2016; and (iii) Bank of Communications (Hong Kong) Limited, a company engaging in the provision of banking and other financial services, since April 1, 2017.

Mr. Tang received a diploma in accounting from the Hong Kong Baptist College (presently known as Hong Kong Baptist University) in November 1976. He was admitted as a fellow of the Chartered Association of Certified Accountants (presently known as Association of Chartered Certified Accountants) in November 1984 and a fellow of the Hong Kong Institute of Certified Public Accountants in February 1988. He was an honorary member of the Court of Hong Kong Baptist University from January 2007 to December 2011, and has been a member of the Court of Hong Kong Baptist University since November 2011. Mr. Tang has also been a member of the disciplinary panel of the Hong Kong Institute of Certified Public Accountants since August 2008. Mr. Tang was conferred with the Honorary University Fellowship by the Hong Kong Baptist University in September 2017.

* For identification purposes only

DIRECTORS AND SENIOR MANAGEMENT

Chow Alexander Yue Nong (周裕農), aged 67, was appointed as an independent non-executive Director on December 15, 2017. Mr. Chow is primarily responsible for supervising and providing independent judgment for the Board.

Mr. Chow has over 30 years of experience in the financial and corporate industry. Mr. Chow was the assistant vice president and the head of China office of The First National Bank of Chicago during 1980. He was an adviser to Bank of Tokyo, Ltd., Hong Kong during 1981. Mr. Chow was the president of ACB International Inc.* (ACB國際有限公司), a company engaging in promoting Sino-American trading, raising overseas funding and promoting the export of goods manufactured in the PRC, in 1988. Mr. Chow has been the director of IST Services Limited, a company providing corporate service, since March 1985.

Mr. Chow has been appointed as an independent non-executive director of Shanghai Zendai Property Limited (stock code: 755), a company engaging in property development business, property investments, management and agency services and hotel operations through its subsidiaries, since June 30, 2015.

Mr. Chow was a director of the following companies which were incorporated in Hong Kong and dissolved by deregistration by the Registrar of Companies of Hong Kong pursuant to section 291AA of the Predecessor Companies Ordinance or section 751 of the Companies Ordinance (as the case may be) and the relevant details are as follows:

Name of the company	Nature of business prior to dissolution	Date of dissolution	Nature of proceeding
Allied Way Financial Consultants Limited (群致理財顧問有限公司)	No business operation <i>(Note 1 and 2)</i>	January 21, 2011	Deregistration
Kealthy Far East Limited (保健遠東有限公司)	No business operation <i>(Note 1 and 2)</i>	November 30, 2001	Deregistration
Sky Bird Services Limited (中翔航空服務有限公司)	No business operation <i>(Note 1 and 2)</i>	February 27, 2015	Deregistration
eDining Limited (易食有限公司)	No business operation <i>(Note 1 and 2)</i>	December 23, 2016	Deregistration

Mr. Chow was also a director of the following company which was incorporated in the BVI and was dissolved on a voluntary basis and the relevant details are as follows:

Name of the company	Nature of business prior to dissolution	Date of dissolution	Nature of proceeding
eDining Holdings Limited	Investment holding <i>(Note 2)</i>	May 11, 2017	Voluntary liquidation

* For identification purposes only

DIRECTORS AND SENIOR MANAGEMENT

Note 1: Under section 291AA of the Predecessor Companies Ordinance or section 750 of the Companies Ordinance, an application for deregistration can only be made if (a) all members of such company agree to such deregistration; (b) such company has never commenced business or operation, or has ceased to carry on business or ceased operation for more than three months immediately before the application; and (c) such company has no outstanding liabilities.

Note 2: As confirmed by Mr. Chow, each of the companies aforementioned in this paragraph had no business operations and solvent at the time of dissolution. Mr. Chow further confirmed that there was no wrongful act on his part leading to the dissolution, and he is not aware of any actual or potential claim that has been or will be made against him as a result of such dissolution.

Mr. Chow received a bachelor of arts degree in computer science and a degree of master of business administration from the University of California, Berkeley, in the United States, in March 1973 and June 1975, respectively. Further, he is a committee member of The Chinese General Chamber of Commerce.

Wong Man Fai (王文輝), aged 69, was appointed as an independent non-executive Director on December 15, 2017. Mr. Wong is primarily responsible for supervising and providing independent judgment for the Board.

Mr. Wong has over 30 years of experience in the insurance industry. He joined American International Underwriters Ltd. (presently known as AIG Insurance Hong Kong Limited, together with its subsidiaries, the “**AIG Group**”) in 1985 and had held various senior management roles in AIG Group over the years. He had been the regional vice president in 1997, the deputy general manager from 2000 to 2001, the country head of AIG China from 2001 to 2003, the president of AIG Hong Kong from 2003 to 2006 and the vice chairman of AIG Taiwan from 2006 to 2011. He was a senior advisor at Starr International Insurance (Asia) Limited from July 2011 to December 2012, senior advisor of AIG from November 2013 to March 2015 and supervisor of the board of AIG Taiwan Insurance Company Limited from 2014 to 2015.

Mr. Wong received his bachelor of science and master of business administration from the Chinese University of Hong Kong, in October 1971 and October 17, 1974, respectively.

Mr. Wong was a director of the following companies which were incorporated in Hong Kong and dissolved by members’ voluntary winding up pursuant to section 228 of the Predecessor Companies Ordinance and the relevant details are as follows:

Name of the company	Nature of business prior to dissolution	Date of dissolution	Nature of proceeding
AIG Banking Insurance Services Limited (美亞集團銀行業保險有限公司)	No business operation	March 8, 2010	Members’ voluntary winding up
China America Insurance Company (Hong Kong) Limited (香港中美保險有限公司)	No business operation	March 7, 2002	Members’ voluntary winding up

DIRECTORS AND SENIOR MANAGEMENT

As confirmed by Mr. Wong, each of the companies aforementioned in this paragraph had no business operations and was solvent at the time of dissolution. Mr. Wong further confirmed that there was no wrongful act on his part leading to the dissolution and he is not aware of any actual or potential claim that has been or will be made against him as a result of such dissolution.

Save as disclosed above, each of our Directors (i) did not hold other positions in our Company or other members of our Group as of the Latest Practicable Date; (ii) had no other relationship with any of our Directors, senior management, Controlling Shareholders or substantial Shareholders as of the Latest Practicable Date; and (iii) held any other directorships in any other company listed in Hong Kong or overseas in the last three years prior to the Latest Practicable Date. Please see “Statutory and General Information” in Appendix IV to this prospectus for further information about our Directors, including the particulars of their service contracts and remuneration, and details of the interests of our Directors in the Shares (within the meaning of Part XV of the SFO). Save as disclosed in this prospectus, there are no other matters in respect of each of our Directors that is required to be disclosed pursuant to Rule 13.51(2) of the Listing Rules and there is no other material matters relating to our Directors that need to be brought to the attention of our Shareholders.

Each of our independent non-executive Directors has confirmed his independence for the purpose of Rule 3.13 of the Listing Rules.

ROLES OF CHAIRMAN AND CHIEF EXECUTIVE OFFICER PERFORMED BY THE SAME INDIVIDUAL

Pursuant to Code Provision A.2.1 of the Corporate Governance Code, the roles of chairman and chief executive officer should be separate and should not be performed by the same individual. Mr. Wong is currently the chairman of the Board and our chief executive officer, responsible for formulating the overall business development strategy and planning of our Group. In view that Mr. Wong has been responsible for the overall management of our Group since 1978, the Board believes that it is in the best interest of our Group to have Mr. Wong taking up both roles for effective management and business development. Our Board considers that the balance of power and authority, accountability and independent decision-making under our present arrangement will not be impaired because of the diverse background and experience of our three independent non-executive Directors. Further, our Audit Committee has free and direct access to our Company’s external auditors and independent professional advisers when it considers necessary. Therefore, our Directors consider that the deviation from Code Provision A.2.1 of the Corporate Governance Code is appropriate in such circumstance. Except for the deviation from the said Corporate Governance Code Provision A.2.1, our corporate governance practices have complied with the Corporate Governance Code.

DIRECTORS AND SENIOR MANAGEMENT

SENIOR MANAGEMENT

The senior management team of our Group, in addition to the executive Directors listed above, is as follows:

Hui Chi Ho (許志豪), aged 44, is our operating officer of group marketing and sales. He is primarily responsible for formulating and overseeing overall sales and marketing strategies and activities of our Group. He joined our Group on July 14, 2003 as a purchasing supervisor and had held various positions within our Group before he was promoted to his current position as the operating officer of group marketing and sales on August 1, 2016. He was the purchasing supervisor from July 2003 to December 2004, the purchasing officer from January 2005 to April 2006, senior marketing executive from April 2006 to September 2006, assistant marketing manager from October 2006 to December 2007, marketing manager from January 2008 to June 2010, group catering marketing manager from July 2010 to December 2011, senior group food service marketing manager from January 2012 to December 2012 and group marketing and sales director from January 2013 to July 2016.

Mr. Hui has over 19 years of experience in purchasing, market and product planning, sales and new business development. Prior to joining our Group, Mr. Hui served Dah Chong Hong Limited from September 1998 to July 2003, with his last position as assistant product manager, during which he was primarily responsible for purchasing and trading of frozen pork and processing pork and handling key accounts in Hong Kong and Macau market.

Mr. Hui received a bachelor degree in marketing from the Hong Kong Polytechnic University in November 1998.

Leung Kim Ming (梁劍明), aged 52, is our chief operating officer of China. He is primarily responsible for formulating our Group's China production and project policies and strategies. He joined our Group on August 20, 2008 as an assistant finance manager and had held various positions within our Group before he was promoted to his current position of chief operating officer of China on January 1, 2016. He was the PRC senior finance manager from September 2010 to March 2012 and chief executive officer of TWCH from April 2012 to December 2015.

Mr. Leung has over 19 years of experience in finance and accounting management. Prior to joining our Group, Mr. Leung served various company in their accounting and management department. From August 1986 to December 1989, he served Persona Education, one of the division of Temporary Center (HK) Co. Ltd., which operated language schools, with his last position as accountant. From February 1994 to January 1997, he served Faithful and Gould Limited as group accountant. He was a senior accounts supervisor of Sing Kwong Jewellery & Gold Co., Ltd. from July 1998 to February 2003. From July 2005 to August 2008, he served China Resources Retail (Group) Co., Ltd., with his last position as senior management accountant.

DIRECTORS AND SENIOR MANAGEMENT

Mr. Leung received a graduation diploma in business administration from Hong Kong Shue Yan College (presently known as Hong Kong Shue Yan University) in July 1989 and a bachelor of arts in accountancy from the University of Bolton (in the United Kingdom) in September 2006.

Kam Chun Pong Bernard (金振邦), aged 61, is our group business director. He is primarily responsible for executing our Group's sales and marketing strategies. He joined our Group on June 1, 2007 as sales and marketing director and after working with us for approximately two years, he left and then rejoined us in May 2014 as group China business director and has become our group business director since August 1, 2016.

Mr. Kam has more than 20 years of experience in marketing, sales management and business development with a focus in the fast moving consumer products industry. Mr. Kam worked at Esso Standard Oil (Hong Kong) Ltd. (presently known as Exxonmobil Hong Kong Limited) from August 1978 to August 1979, with his last position as distribution assistant in the cost and operations department. He then worked for Compu-AD Centre Limited as account executive from August 1979 to July 1980. Thereafter, Mr. Kam served Leo Burnett Ltd. during 1982, with the position as sales promotion and merchandising manager. He rejoined Compu-AD Centre Limited as general manager and director of account service from August 1982 to September 1983. He then joined Nestle China Limited (presently known as NHK Tradings Co. Limited) ("Nestle China") as advertising manager in 1984 and left as marketing service manager in October 1988. Mr. Kam was product manager in the foods marketing department of Ashley-Koffman Foods in Canada from July 1989 to November 1991. He returned to Nestle China in January 1992 and worked as a group product manager, primarily responsible for marketing coffee and instant drinks in the PRC market, and was promoted as marketing manager of PRC market in May 1994. He then worked as director of marketing for East Asia of Pepsico Inc. from September 1995 to 1996. After joining our Group in 2007, he left us in October 2009 for Lesaffre (Mingguang) Co. Ltd., where he held the position as group sales and marketing director of China.

Mr. Kam received a higher diploma in business studies from Hong Kong Polytechnic (presently known as Hong Kong Polytechnic University) in November 1978 and a diploma in marketing from the Institute of Marketing (in the United Kingdom) in June 1983. He also completed a ten-week international general management program, namely Program for Executive Development at the International Institute for Management Development in Switzerland in October 1994.

Chan Pei Shun (陳彼信), aged 51, is our director of risk management and operation control. He is primarily responsible for maintaining risk management and internal control system. He joined our Group in July 2004 as management information systems manager and had held various positions within our Group before he was promoted to his current position as the director of risk management and operation control on October 1, 2016. He was the group management information systems manager from April 2006 to December 2007, head of supply chain and technology department from January 2008 to July 2011 and group trading business director from August 2011 to September 2016.

DIRECTORS AND SENIOR MANAGEMENT

Mr. Chan has more than 20 years of diversified business management experiences in the information technology industry. Prior to joining our Group, Mr. Chan served Motorola Asia Pacific Limited from August 1995 to May 2003, with his last position as IT systems engineer of their global infrastructure solutions department. He also served Automated Systems (HK) Limited as engineer IT systems III in the infrastructure and managed services division from June 2003 to July 2004.

Mr. Chan received a bachelor of engineering in digital systems engineering from the University of Sunderland, United Kingdom, in June 1993, and a master of science in management from the Hong Kong Polytechnic University in November 2000. He was a member of The Institution of Electrical and Electronics Engineers from 1993 to 2008. Mr. Chan was recognized as a certified member of the America Society of Transportation and Logistics in May 2009 and has been admitted as a member of The Institution of Engineering and Technology since 2005. He was certified as a certified SCOR Professional by the Supply Chain Council in February 2010.

Law Wan Yee Sandy (羅韻儀), aged 42, is our internal audit manager. She is primarily responsible for overseeing corporate governance and internal control matters. She joined our Group on December 22, 2003 as an internal audit officer and was promoted to her current position of internal audit manager in July 2006.

Ms. Law has 20 years of audit experience, specializing in food, beverages and manufacturing industry. Before joining our Group, she had served Deloitte Touche Tohmatsu from August 1997 to March 2001, with her last position as semi-senior accountant, during which she was primarily responsible for assuming the overall control of small to medium-sized audit assignments. She also served Dickson Concepts Limited as internal audit officer from March 2001 to June 2002, during which she was primarily responsible for carrying out regular audit routines and performing systems evaluations. She worked in Elite Industrial Holdings Ltd., a company engaging in manufacturing of equipment and machinery, as an internal auditor from September 2002 to December 2003, during which she was primarily responsible for the internal audit function.

Ms. Law received a bachelor degree in accountancy from the Hong Kong Polytechnic University in November 1997. She was admitted as a fellow of The Association of Chartered Certified Accountants in December 2005 and was certified to be a Certified Public Accountant by the Hong Kong Institute of Certified Public Accountants in April 2006.

COMPANY SECRETARY

Wu Kam On Keith (鄔錦安), aged 43, was appointed as our company secretary of our Company on August 18, 2017. For his biographical details, please refer to the paragraphs headed “Directors — Executive Directors” in this section.

DIRECTORS AND SENIOR MANAGEMENT

CORPORATE GOVERNANCE

Our Company is committed to achieving high standards of corporate governance with a view to safeguarding the interests of our Shareholders. To accomplish this, our Company intends to comply with the corporate governance requirements (except for the deviation from Code Provision A.2.1 of the Corporate Governance Code with details set out in the paragraph headed “Roles of chairman and chief executive officer performed by the same individual” above in this section) under the Corporate Governance Code and Corporate Governance Report set out in Appendix 14 to the Listing Rules after the Listing.

COMMITTEES UNDER THE BOARD OF DIRECTORS

Our Company currently has three committees under the Board, which are the Audit Committee, the Nomination Committee and the Remuneration Committee. These committees operate in accordance with their respective terms of reference established by the Board.

Audit Committee

Our Company established an audit committee with written terms of reference in compliance with Rule 3.21 of the Listing Rules and the Corporate Governance Code. The audit committee consists of three members, namely Mr. Tang Kwai Chang, Mr. Chow Alexander Yue Nong and Mr. Wong Man Fai, each being our independent non-executive Director. Mr. Tang Kwai Chang has been appointed as the chairman of the audit committee and is our independent non-executive Director possessing the appropriate professional qualifications. The primary duties of the audit committee are to review and supervise the financial reporting process and internal control system of our Group, oversee the audit process and perform other duties and responsibilities as assigned by our Board.

Nomination Committee

Our Company established a nomination committee with written terms of reference in compliance with the Corporate Governance Code. The nomination committee consists of three members, namely Mr. Chow Alexander Yue Nong (our independent non-executive Director), Mr. Wong Tat Tong (our chairman, chief executive officer and executive Director) and Mr. Wong Man Fai (our independent non-executive Director). Mr. Chow Alexander Yue Nong has been appointed as the chairman of the nomination committee. The primary duties of the nomination committee are to make recommendations to our Board on the appointment and removal of Directors of our Company.

DIRECTORS AND SENIOR MANAGEMENT

Remuneration Committee

Our Company established a remuneration committee with written terms of reference in compliance with Rule 3.25 of the Listing Rules and the Corporate Governance Code. The remuneration committee consists of three members, namely Mr. Wong Man Fai (our independent non-executive Director), Mr. Wong Tat Tong (our chairman, chief executive officer and executive Director) and Mr. Tang Kwai Chang (our independent non-executive Director). Mr. Wong Man Fai has been appointed as the chairman of the remuneration committee. The primary duties of the remuneration committee are to establish and review the policy and structure of the remuneration for our Directors and senior management and make recommendations on employee benefit arrangement.

COMPENSATION OF DIRECTORS AND SENIOR MANAGEMENT

The aggregate amount of remuneration our Directors received (including fees, salaries, contributions to pension schemes, discretionary bonuses, housing and other allowances and other benefits in kind) for the years ended December 31, 2015, 2016 and 2017 was HK\$8.7 million, HK\$8.8 million and HK\$8.5 million, respectively.

The aggregate amount of fees, salaries, contributions to pension schemes, discretionary bonuses, housing and other allowances and other benefits in kind paid to our five highest paid individuals of our Company, excluding Directors, for each of the years ended December 31, 2015, 2016 and 2017 was HK\$2.7 million, HK\$3.6 million and HK\$3.5 million, respectively.

Under the arrangements currently in force, the aggregate amount of remuneration, excluding discretionary bonuses, payable to our Directors for the year ending December 31, 2018 is estimated to be HK\$10.2 million.

No remuneration was paid by us to our Directors or the five highest paid individuals as an inducement to join or upon joining us or as a compensation for loss of office for the years ended December 31, 2015, 2016 and 2017. Further, none of our Directors had waived any remuneration during the same periods.

Save as disclosed above, no other payments have been made or are payable for each of the three years ended December 31, 2015, 2016 and 2017 by our Group to our Directors.

Our Board will review and determine the remuneration and compensation packages of our Directors and senior management which, following the Listing, will receive recommendation from the Remuneration Committee which will take into account salaries paid by comparable companies, time commitment and responsibilities of our Directors and senior management and performance of our Group.

DIRECTORS AND SENIOR MANAGEMENT

COMPLIANCE ADVISOR

We have appointed BOSC International Company Limited as our compliance advisor (the “**Compliance Advisor**”) upon listing of our Shares on the Hong Kong Stock Exchange in compliance with Rule 3A.19 of the Listing Rules. Pursuant to Rule 3A.23 of the Listing Rules, the Compliance Advisor will provide advice to us when consulted by us in the following circumstances:

- (i) before the publication of any regulatory announcement, circular or financial report;
- (ii) where a transaction, which might be a notifiable or connected transaction, is contemplated including share issues and share repurchases;
- (iii) where we propose to use the proceeds of the Global Offering in a manner different from that detailed in this prospectus or where its business activities, developments or results deviate from any forecast, estimate, or other information in this prospectus; and
- (iv) where the Hong Kong Stock Exchange makes an inquiry of our Company under Rule 13.10 of the Listing Rules.

The term of the appointment shall commence on the Listing Date and end on the date on which our Company distributes its annual report in respect of its financial results for the first full financial year commencing after the Listing Date in compliance with Rule 13.46 of the Listing Rules.

FUTURE PLANS AND USE OF PROCEEDS

FUTURE PLANS

See the section headed “Business — Our Business Strategies” in this prospectus for a detailed description of our future plans.

USE OF PROCEEDS

We estimate the net proceeds from the new Shares as part of the Global Offering which we will receive, assuming an Offer Price of HK\$1.84 per Offer Share (being the mid-point of the Offer Price range stated in this prospectus), will be approximately HK\$149.7 million, after deduction of underwriting fees and commissions and estimated expenses payable by us in connection with the Global Offering and assuming the Over-allotment Option is not exercised.

We intend to use the net proceeds of the Global Offering for the following purposes:

- approximately 40% (approximately HK\$59.8 million) will be used for further strengthening of our ability to provide food and beverage products solutions to our customers, which includes:
 - (a) approximately HK\$50.3 million for potential future business or share acquisitions, joint ventures or other strategic arrangements with entities that have:
 - (i) product portfolios demanded by our customers, including meat, flour and/or dairy products, which are key items commonly demanded by our customers, namely Cha Chaan Teng, fast food chains and restaurants, and would further complement our existing beverage solutions and frozen meat product portfolio;
 - (ii) distribution channels to food outlets such as Chinese restaurants and other targeted customers that are currently not covered by our existing distribution network, stable track record, established food safety control procedures, potential growth in local and overseas market, and an established business to business distribution network that allows us to enlarge and enhance our customer base, to expand and enhance our product portfolio and to deepen our market penetration. Please refer to the section headed “Business — Our Business Strategies — Continue to strengthen our frozen meat and frozen processed food products business and expand our product offerings.” in this prospectus for details;
 - (b) approximately HK\$1.5 million for acquiring a cold storage delivery truck in Hong Kong which is expected to be deployed as part of the Group’s logistics team in 2019; and

FUTURE PLANS AND USE OF PROCEEDS

- (c) approximately HK\$8.0 million for collaborating with NH Foods and establishing a simple frozen meat processing line by the end of 2019 as part of our expansion in the frozen meat business to provide frozen food products according to our customers' specifications. Currently, we have not entered into any formal discussions or arrangements with NH Foods on the establishment of the frozen meat processing line in Hong Kong, and we expect to complete a feasibility study on such frozen food processing line in the second half of 2019. Please refer to the paragraph headed "Business — Our Business Strategies — Continue to strengthen our frozen meat and frozen processed food products business and expand our product offerings." in this prospectus for details.

For our acquisition targets, we seek to invest in projects with a 10–15% internal rate of return, subject but not limited to the following factors: current market situation, volatility of currency risk of target market and whether the acquired target outperforms amongst the industry. As to the payback period, we seek to invest in projects with payback periods of approximately five to ten years, subject but not limited to the following factors: the return of investment, future growth potential and the level of synergy created by the merger.

We would re-allocate the relevant portion of proceeds proportionately to other use of proceeds categories in the event that we do not acquire the cold storage delivery truck and establish the frozen meat processing line. We shall comply with the relevant Listing Rules to announce the change in use of proceeds.

- approximately 20% (approximately HK\$29.9 million) will be used for capital investments in relation to acquiring, expanding, streamlining or upgrading our manufacturing plants, premises, facilities, equipment or capabilities, with the aim to (i) enhance our production efficiency or reduce our operating costs, and/or (ii) expand our product portfolio. We intend to spend:
 - (a) approximately HK\$12.4 million for acquiring new coffee machines for our customers as (i) it is not uncommon for us to receive orders for new coffee machines with a range from HK\$1.0 million to HK\$2.0 million, (ii) a material portion of the coffee machines which we have leased to our customers have a nil net book value and may need to be replaced in the near term, and (iii) we procured close to HK\$10.0 million of coffee machines each year during the Track Record Period. As delivery of the right equipment (including coffee machines) to ensure end user experience is an integral part of our "integrated solutions" business model, we believe it is necessary to allocate approximately HK\$12.4 million proceeds in this regard in order to be able to deliver the coffee machines as ordered;

FUTURE PLANS AND USE OF PROCEEDS

- (b) approximately HK\$6.0 million for upgrading coffee roasters in our Hong Kong facility which is expected to enhance production efficiency by shortening production time and reducing production errors and to increase the our production capacity of coffee products by approximately 25%;
 - (c) approximately HK\$7.0 million for setting up a warehouse and renovating facilities, including purchases of necessary equipments in Hong Kong and setting up a new warehouse in the PRC on or before the end of 2020 as we are required to demolish the Dongguan Warehouses and relocate the raw materials and finished goods stored in the Dongguan Warehouses upon expiry of the temporary construction permit (with respect to which we obtained for one Dongguan Warehouse and are currently applying for the other Dongguan Warehouse) (Please refer to the section headed “Business — Legal Proceedings and Compliance — Non-compliance Matters” in this prospectus for details). In addition, to prepare against the possibility that we may not receive the temporary construction permit, we intend to relocate the raw materials and finished products stored in the Dongguan Warehouses to our other properties, and lease other warehouse premises at similar locations; and
 - (d) approximately HK\$4.5 million for installing additional machinery in our facilities (including equipment used to detect foreign objects, equipment for better working environment for our employees and packing equipment to cater to small-size packaging for tea (which is not interchangeable for coffee) to support our business expansion and replace some of the existing packing machines that are reaching the end of their useful life). Of the HK\$4.5 million, we intend to spend HK\$1.5 million on a triangle tea bag packaging machine and equipments for better working environment in our PRC facility, HK\$2.0 million for small tea packaging machines in the Hong Kong facility and HK\$1.0 million for equipment for detecting foreign objects in both our Hong Kong and the PRC facilities. In terms of timing for our packaging machine expenditure, we expect to incur HK\$2.5 million in 2018 and an aggregation of HK\$1.0 million in 2019 and 2020, which we project would expand our overall packaging capacity by 10%.
- approximately 10% (approximately HK\$15.0 million) will be used for expanding our food and beverage business in Southeast Asia, including the costs of setting-up representative offices and commercially-viable strategic acquisition. In Southeast Asia we seek to acquire entity(ies) with sourcing capability to (i) strengthen our sourcing channels, including coffee from Vietnam, tea from Sri Lanka and milk from Thailand and Malaysia, and (ii) expand our portfolio of raw materials, to enhance our supply channels and cost control capability. We currently focus on understanding the legal and commercial regimes of the relevant markets in Southeast Asia and we intend to engage an expert to conduct feasibility studies on matters that include the market condition and potential growth trend

FUTURE PLANS AND USE OF PROCEEDS

of such target entity, and the operational model and respective procedures for setting up representative office, once we identify a target market and expect to complete such market research within six months of commencement;

- approximately 10% (approximately HK\$15.0 million) will be used for pursuing product customization and development, whether in-house or through collaboration with external parties, and enhancing our technological capabilities. We plan to spend:
 - (a) approximately HK\$10.0 million for the development (including creating the mold for such machine) of a fully automated tea machine in collaboration with Rex-Royal to complement our tea products. As of the Latest Practicable Date, we have conducted preliminary feasibility study on the tea machines, including a study on the target market segment channel, proposed target customers, business models/plan for investment (direct sales, free rental along with product distribution), the safety standards as requested by specific customers, and the potential target sales in both Hong Kong and the PRC regions. Based on the feasibility study we had conducted and past experience of selling tea machines to customers including Cha Chaan Tengs, hotels and convenience stores, we believe there would be sufficient demand for this automated tea machine. Currently, Rex-Royal has been providing technical advices during the development process, and we have not engaged in any formal collaboration agreement with Rex-Royal for the project. Furthermore, pending on further discussions with Rex-Royal, we seek to (i) have sole proprietary ownership of the intellectual property rights to this tea machine, or (ii) receive exclusive right to use and distribute such machine on certain geographical locations especially Hong Kong and the PRC;
 - (b) approximately HK\$1.0 million to upgrade the existing product development laboratories in Hong Kong and the PRC, which includes purchase of equipments that can be applied to procure more detailed data for new products and formulations as part of its plan to upgrade of existing product development laboratories in Hong Kong and installation of instruments for the purpose of measuring the ingredients and products profile such as colour index, size test and product tasting to fulfill the food safety requirement and customer's specification. Of the HK\$1.0 million, approximately HK\$0.5 million will be applied for upgrading the laboratories in Hong Kong and HK\$0.5 million for additional and replacement of instruments and equipments in Hong Kong and the PRC;
 - (c) approximately HK\$1.0 million to engage external consultants for the market research on new products and markets which primarily cover the macro economy, such as local economy, demographics and consumption expenditure, of the target geographical locations including Singapore, Sri Lanka, Thailand and Malaysia;

FUTURE PLANS AND USE OF PROCEEDS

- (d) approximately HK\$1.0 million to engage external consultants for conducting industrial analysis, which primarily cover the specific business condition, such as market size of the products, coverage in different channels, growth rate, key growth drivers and competitive landscape, of the target industry including the meat, dairy and flour industries;
- (e) approximately HK\$1.0 million for beverage solutions formulation which includes costs incurred relating to conducting studies on new products with a focus on change in formulation to increase the taste flavoring and profile, including but not limited to increasing coffee and tea element extraction. Such study is different from our market research and industry analysis, which is performed at a macroeconomic level; and
- (f) approximately HK\$1.0 million for food products sampling and testing, including conducting microbiological quality tests and chemical analysis;
- approximately 10% (approximately HK\$15.0 million) will be used for bolstering our sales, marketing and advertising efforts to enhance brand recognition and fortify brand loyalty for our products and businesses. We plan to spend:
 - (a) approximately HK\$5.6 million on participating exhibitions;
 - (b) approximately HK\$3.8 million on placing advertisements;
 - (c) approximately HK\$2.5 million on sponsoring coffee and tea plantation trips and coffee courses and other joint promotion activities, including joint brand promotion and products promotion; and
 - (d) approximately HK\$3.1 million will be used on enhancing information technology system and hardware that help us better track our sales, which in turn, supports our sales, marketing and advertising efforts that can fortify our brand loyalty; and
- approximately 10% (approximately HK\$15.0 million) will be used for working capital and other general corporate purposes.

As of the Latest Practicable Date, save for entering into a strategic cooperation agreement with NH Foods in July 2017 and a memorandum of understanding with F&N in April 2018, we had not engaged in any negotiations or entered into any letter of intent or any definitive and finalized understanding, commitment or agreement, legally binding or not, in connection with any of the above potential acquisitions or business cooperation nor had we commenced any due diligence process in relation to the same. We may identify potential targets through our internal research, referral by our business partners, contacts or market agents with a focus on those which are sustainable and complementary to our business and in line with our business strategies from time to time. Currently, we do not set any monetary thresholds for potential targets. Apart from proceeds from the Global Offering, we may use other fund raising methods including equity or debt financing or bank borrowings as and when further funds are needed for acquisitions or business cooperation.

FUTURE PLANS AND USE OF PROCEEDS

Our Board will review and, if it thinks fit, discuss, review and approve the relevant acquisition or business cooperation proposals and will also ensure that our acquisitions or business cooperation will be made in compliance with the Listing Rules, applicable laws and regulations.

If the Offer Price is fixed at HK\$2.19 per Offer Share (being the high end of the Offer Price range stated in this prospectus) and assuming the Over-allotment Option is not exercised, we will receive additional net proceeds of approximately HK\$35.8 million. If the Offer Price is fixed at HK\$1.50 per Offer Share (being the low end of the Offer Price range stated in this prospectus) and assuming the Over-allotment Option is not exercised, the net proceeds we receive will be reduced by approximately HK\$34.7 million. The above allocation of the proceeds will be adjusted on a pro rata basis in the event that the Offer Price is fixed at a higher or lower level compared to the mid-point of the estimated Offer Price range.

The additional net proceeds that we would receive if the Over-allotment Option were exercised in full would be (i) HK\$75.6 million (assuming an Offer Price of HK\$2.19 per Share, being the high-end of the Offer Price range stated in this prospectus), or (ii) HK\$63.5 million (assuming an Offer Price of HK\$1.84 per Share, being the mid-point of the Offer Price range stated in this prospectus), or (iii) HK\$51.8 million (assuming an Offer Price of HK\$1.50 per Share, being the low-end of the Offer Price range stated in this prospectus). Additional net proceeds received due to the exercise of any Over-allotment Option will be used for the above purposes accordingly on a pro rata basis in the event that the Over-allotment Option is exercised.

To the extent that the net proceeds are not immediately applied to the above purposes and to the extent permitted by applicable law and regulations, we intend to deposit the net proceeds into short-term demand deposits or money market instruments.

We estimate that the net proceeds to be received by the Selling Shareholder from the sale of the Sale Shares (after deduction of underwriting commissions payable by our Selling Shareholder in relation to the Global Offering, and assuming an Offer Price of HK\$1.84 per Offer Share, being the mid-point of the Offer Price range, and the Over-allotment Option being not exercised) are approximately HK\$235.4 million. We will not receive any of the proceeds from the Sale Shares.

In the event of any material change in our use of net proceeds of the Global Offering from the purposes described above or in our allocation of the net proceeds among the purposes described above, a formal announcement will be made in accordance with the Listing Rules.

UNDERWRITING

HONG KONG UNDERWRITERS

BOCI Asia Limited
DBS Asia Capital Limited
Kingsway Financial Services Group Limited
Future Land Resources Securities Limited
VBG Capital Limited

UNDERWRITING ARRANGEMENTS AND EXPENSES**Hong Kong Public Offering***Hong Kong Underwriting Agreement*

Pursuant to the Hong Kong Underwriting Agreement, our Company has agreed to offer the Hong Kong Offer Shares for subscription by the public in Hong Kong on and subject to the terms and conditions of this prospectus, the Application Forms and the Hong Kong Underwriting Agreement. Subject to, among other conditions, the granting of the listing of, and permission to deal in, the Shares in issue and to be issued as mentioned in this prospectus by the Listing Committee and to certain other conditions set out in the Hong Kong Underwriting Agreement (including, among others, the Sole Global Coordinator, for itself and on behalf of the Underwriters, and our Company, for itself and on behalf of the Selling Shareholder agreeing to the final Offer Price), the Hong Kong Underwriters have agreed to subscribe or procure subscribers to subscribe for the Hong Kong Offer Shares now being offered which are not taken up under the Hong Kong Public Offering on the terms and conditions of this prospectus, the Application Forms and the Hong Kong Underwriting Agreement. The Hong Kong Underwriting Agreement is conditional upon and subject to, among others, the International Underwriting Agreement having been signed and becoming unconditional.

Grounds for termination

The obligations of the Hong Kong Underwriters under the Hong Kong Underwriting Agreement are subject to termination with immediate effect by the Sole Global Coordinator, in its sole and absolute discretion (for itself and on behalf of the Hong Kong Underwriter) by notice orally or in writing to our Company prior to 8:00 a.m. on the Listing Date if:

- (a) there develops, occurs, exists or comes into effect:
 - (i) any event or series of events resulting in or representing a calamity or crisis or a change or development involving a prospective change, in local, national, regional or international financial, political, military, industrial, economic, fiscal or market conditions or sentiments (including, without limitation, conditions and sentiments in stock and bond markets, money and foreign exchange markets, investment and credit markets and inter-bank markets) or currency exchange rate or controls in or affecting Hong Kong, Macau, the PRC, the United States, Japan, Australia, the European Union

UNDERWRITING

- (or any member thereof), Singapore, the BVI, the United Kingdom and Bermuda, or any other jurisdiction relevant to any member of our Group (collectively the “**Relevant Jurisdictions**”); or
- (ii) any new law or regulation or any change or development involving a prospective change in any existing law or regulation, or any change or development involving a prospective change in the interpretation or application thereof by any court or other competent authority in or affecting any of the Relevant Jurisdictions; or
 - (iii) any event or series of events in the nature of force majeure (including, without limitation, acts of government, labour disputes, strikes, lock-outs, fire, explosion, flooding, civil commotion, riots, public disorder, declaration of a national or international emergency, acts of war, acts of God, acts of terrorism (whether or not responsibility has been claimed), epidemic, pandemic, outbreak of infectious disease (including without limitation SARS, MERS, H5N1, H7N9 or H1N1 or swine or avian influenza or such related/mutated forms), accident or interruption or delay in transportation or economic sanctions) in or affecting any of the Relevant Jurisdictions; or
 - (iv) without limiting the foregoing, any local, national, regional or international outbreak or escalation of hostilities (whether or not war is or has been declared), act of terrorism (whether or not responsibility has been claimed), or other state of emergency or calamity or crisis in or affecting any of the Relevant Jurisdictions; or
 - (v) the imposition or declaration of (A) any moratorium, suspension, restriction (including, without limitation, any imposition of or requirement for any minimum or maximum price limit or price range) or limitation on trading in shares or securities generally on the Hong Kong Stock Exchange, the New York Stock Exchange, the NASDAQ Global Market, NYSE Amex Equities, the Tokyo Stock Exchange, the Shanghai Stock Exchange, the Shenzhen Stock Exchange, the London Stock Exchange, the Singapore Stock Exchange or the stock exchange in any other member of the European Union or (B) any moratorium on, or disruption in, banking activities (commercial or otherwise) or foreign exchange trading or securities settlement or clearing services in or affecting any of the Relevant Jurisdictions; or
 - (vi) any change or development involving a change or prospective change in taxation or exchange controls (or the implementation of any exchange control) or currency exchange rates or foreign investment regulations in or affecting any of the Relevant Jurisdictions (including without limitation any fluctuation in the Hong Kong dollars or Renminbi against any foreign currencies); or

UNDERWRITING

- (vii) the commencement by any authority or other regulatory or political body or law enforcement agency or organisation of any action or investigation against a Director or an announcement by any authority or regulatory or political body or law enforcement agency or organisation that it intends to take any such action; or
- (viii) any imposition of economic sanction or withdrawal of trading privileges, in whatever form, directly or indirectly, by, or for, the U.S. or the European Union (or any member thereof) on any of the Relevant Jurisdictions; or
- (ix) any change in the system under which the value of the Hong Kong dollar is linked to that of the U.S. dollar or the value of the RMB is determined by reference to a basket of world currencies or a material devaluation of Hong Kong dollars or the Renminbi against any foreign currency; or
- (x) any change or development or event involving a prospective change in our Group's assets, liabilities, profit, losses, performance, condition, business, financial, earnings, trading position or prospects, or any change in capital stock or long-term debt of our Company or any other member of our Group, or any loss or interference with the assets, operations or business of our Company or any other member of our Group, which (in any such case) is not set forth in this prospectus; or
- (xi) save as disclosed in this prospectus, a demand by any tax authority for payment for any tax liability for any member of our Group; or
- (xii) a demand by any creditor for repayment or payment of any indebtednesses of any member of our Group or in respect of which any member of our Group is liable prior to its stated maturity; or
- (xiii) non-compliance of this prospectus (or any other documents used in connection with the contemplated subscription of the Hong Kong Public Offer Shares) or any aspect of the Global Offering with the Listing Rules or any other applicable law; or
- (xiv) the issue or requirement to issue by our Company of a supplemental prospectus or amendment to this prospectus,

and which, in any such case (whether individually or in the aggregate) and in the sole and absolute opinion of the Sole Global Coordinator (for itself and on behalf of the Hong Kong Underwriters): (A) is or will or may be materially adverse to, or materially and prejudicially affect, the assets, liabilities, the business, general affairs, management, shareholder's equity, profit, losses, results of operations or financial or trading position or condition, or prospects of our Group as a whole or any present or prospective shareholder of our Company in its capacity as such; or (B) has or will or may have a material adverse effect on the success of the Global Offering or the level of Offer Shares being applied for or accepted or the distribution of the Offer Share and/or make it impracticable, inadvisable, in

UNDERWRITING

expedient or not commercially viable for any part of the Hong Kong Underwriting Agreement, the Hong Kong Public Offering or the Global Offering to be performed or implemented as envisaged; or (C) makes or will or may make it impracticable, inadvisable, inexpedient, incapable or not commercially viable to proceed with any part of the Hong Kong Underwriting Agreement, the Hong Kong Public Offering and/or the Global Offering or the delivery of Shares on the terms and in the manner contemplated by this prospectus or for any part of the Hong Kong Underwriting Agreement or the Global Offering to be performed or implemented as envisaged; or

- (b) there has come to the notice of the Sole Global Coordinator after the date of the Hong Kong Underwriting Agreement or it has reasonable cause to believe:
- (i) that any statement contained in any of the formal notice in relation to the Hong Kong Public Offering, this prospectus or the Application Forms or other documents relating to the Global Offering was or has become untrue or incorrect or incomplete or misleading in any respect, or that any estimate, forecast, expression of opinion, intention or expectation contained in this prospectus or any notice, advertisement or announcement issued by our Company in connection with the Hong Kong Public Offering (including any supplement or amendment thereto) is not fair and honest and based on reasonable assumptions with reference to the facts and circumstances then subsisting; or
 - (ii) any matter which would, if the formal notice in relation to the Hong Kong Public Offering, this prospectus and the Application Forms or other documents relating to the Global Offering, and/or any notice, advertisement or announcement issued or used by or on behalf of our Company in connection with the Hong Kong Public Offering (including any supplement or amendment thereto) were issued at that time, constitute a material omission therefrom; or
 - (iii) that any of the Warranties (as defined in the Hong Kong Underwriting Agreement) or representations and warranties given by our Company, our executive Directors, our Controlling Shareholders and our Selling Shareholder under the Hong Kong Underwriting Agreement and/or the International Underwriting Agreement is (or would if repeated at that time be) breached or is untrue or incorrect in any respect or misleading; or
 - (iv) any matter, event, act or omission which gives or is likely to give rise to any liability on the part of our Company or our executive Director and our Controlling Shareholders and our Selling Shareholder out of or in connection with any breach, inaccuracy and/or incorrectness of the Warranties (as defined in the Hong Kong Underwriting Agreement) and/or the indemnities given by our Company, our executive Directors, our Controlling Shareholders and our Selling Shareholder or any of them under the Hong Kong Underwriting Agreement; or

UNDERWRITING

- (v) any event, act or omission which gives rise or is likely to give rise to any liability of our Company any of our executive Directors or our Controlling Shareholders or our Selling Shareholder pursuant to the indemnities under the Hong Kong Underwriting Agreement; or
- (vi) any material breach of any of the obligations or undertakings of our Company, our executive Directors, our Controlling Shareholders or our Selling Shareholder under the Hong Kong Underwriting Agreement, the International Underwriting Agreement or any other agreement relating to the Global Offering as determined by the Sole Global Coordinator in its sole and absolute opinion; or
- (vii) any material adverse change in or any development involving a prospective material adverse change in, or a materialisation of any of, any of the risks set out in the section headed “Risk Factors” in this prospectus; or
- (viii) that (A) any Director, chief executive officer or chief financial officer of our Company named in this prospectus seeks to resign or retire, or is removed from office, or (B) any certificate given by our Company or any of its officers to the Sole Global Coordinator under or in connection with the Hong Kong Underwriting Agreement or the Global Offering is false or misleading in any material respect, or (C) any Director or any member of senior management as named in this prospectus is being charged with an indictable offence or prohibited by operation of law or otherwise disqualified from taking part in the management of a company, or (D) a regulatory, governmental or administrative authority (including any stock exchange) or law enforcement agency or a political body or organisation in any jurisdiction commencing any investigation or other action, or announcing an intention to investigate or take other action, against any Director; or
- (ix) the commencement by any judicial, regulatory, governmental or political body or law enforcement agency or organisation of any material action, claim or proceedings against any Director or an announcement by any judicial, regulatory, governmental or political body or law enforcement agency or organisation that it intends to take any such action; or
- (x) save as disclosed in this prospectus, a material contravention by any member of our Group of the Listing Rules or the Companies Ordinance or any applicable laws or regulations; or
- (xi) any material litigation, legal action or claim being threatened or instigated against any member of our Group, our Directors or our Controlling Shareholders; or
- (xii) a petition is presented for the winding-up or liquidation of any member of our Group or any member of our Group makes any composition or arrangement with its creditors or enters into a scheme of arrangement or any resolution is passed for the winding-up of any member of our Group or a

UNDERWRITING

provisional liquidator, receiver or manager is appointed over all or part of the assets or undertaking of any member of our Group or anything analogous thereto occurs in respect of any member of our Group; or

- (xiii) a prohibition on our Company or our Selling Shareholder for whatever reason from allotting, issuing or selling the Offer Shares (including the Shares to be sold pursuant to the exercise of the Over-allotment Option) pursuant to the terms of the Global Offering; or
- (xiv) our Company withdraws this prospectus and/or the Application Forms; or
- (xv) approval by the Listing Committee for the listing of, and permission to deal in, the Shares to be issued or sold (including any Shares that may be sold pursuant to the exercise of the Over-allotment Option and the options which have been granted under the Pre-IPO Share Option Scheme or which may be granted under the Share Option Scheme) under the Global Offering is refused or not granted, other than subject to customary conditions, on or before the date of approval of the listing, or if granted, the approval is subsequently withdrawn, qualified (other than by customary conditions) or withheld;
- (xvi) any expert, other than the Joint Sponsors, has withdrawn its respective consent to the issue of this prospectus with the inclusion of its reports, letters, summaries of valuations and/or legal opinions (as the case may be) and references to its name included in the form and context in which it respectively appears; or
- (xvii) a significant portion of the orders in the bookbuilding process at the time the International Underwriting Agreement is entered into, or the investment commitments by any corporate or cornerstone investors after signing of agreements with such corporate or cornerstone investors, have been withdrawn, terminated or cancelled or if any corporate or cornerstone investors is unlikely to fulfill its obligation under the respective agreement.

Undertakings to the Hong Kong Stock Exchange under the Listing Rules***By us***

Pursuant to Rule 10.08 of the Listing Rules, we have undertaken to the Hong Kong Stock Exchange that, except pursuant to the Global Offering, the Over-allotment Option, the Stock Borrowing Agreement and the Share Option Schemes as described and contained in this prospectus, no further Shares or securities of our Company convertible into our equity securities (whether or not of a class already listed) may be issued by us or form the subject of any agreement to such an issue by us within six months from the Listing Date (whether or not such issue of Shares or securities will be completed within six months from the Listing Date), except for the circumstances as permitted by Rule 10.08 of the Listing Rules.

UNDERWRITING

By our Controlling Shareholders

Pursuant to Rule 10.07(1) of the Listing Rules, each of our Controlling Shareholders has undertaken to the Hong Kong Stock Exchange and our Company respectively that, except pursuant to the Stock Borrowing Agreement, the Global Offering, the Over-allotment Option and the Share Option Schemes as described and contained in this prospectus, it/he shall not and shall procure that the relevant registered shareholder(s) shall not:

- (a) in the period commencing on the date of this prospectus and ending on the date which is six months from the Listing Date, dispose of, or enter into any agreement to dispose of or otherwise create any options, rights, interests or encumbrances in respect of, any of those Shares in respect of which it/he is shown by this prospectus to be the beneficial owners (whether direct or indirect); or
- (b) in the period of six months commencing on the date on which the period referred to in paragraph (a) above expires, dispose of, or enter into any agreement to dispose of or otherwise create any options, rights, interests or encumbrances in respect of, any of the Shares referred to in paragraph (a) above if, immediately following such disposal or upon the exercise or enforcement of such options, rights, interests or encumbrances, it/he would cease to be a Controlling Shareholder (as defined in the Listing Rules).

Each of our Controlling Shareholders has also undertaken to the Hong Kong Stock Exchange and our Company respectively that, within the period commencing on the date of this prospectus and ending on the date which is 12 months from the Listing Date, it/he will:

- (a) when it/he pledges or charges any Shares beneficially owned by it/him in favour of an authorized institution (as defined in the Banking Ordinance (Chapter 155 of the Laws of Hong Kong) pursuant to Note 2 to Rule 10.07(2) of the Listing Rules, immediately inform us of such pledge or charge together with the number of Shares so pledged or charged; and
- (b) when it/he receives indications, either verbal or written, from the pledgee or chargee that any of the pledged or charged Shares will be disposed of, immediately inform us of such indications.

Our Company shall also inform the Hong Kong Stock Exchange in writing as soon as it has been informed of the above matters (if any) by our Controlling Shareholders and disclose such matters by way of an announcement published in accordance with the Listing Rules as soon as possible. For the avoidance of doubt, our Company shall comply with Rule 13.17 of the Listing Rules at all times upon Listing.

UNDERWRITING

Undertakings pursuant to the Hong Kong Underwriting Agreement***By us***

Our Company has undertaken to each of the Sole Global Coordinator, the Joint Sponsors, the Joint Bookrunners, the Joint Lead Managers and the Hong Kong Underwriters that, except pursuant to the Global Offering, the Over-allotment Option and options which have been granted under the Pre-IPO Share Option Scheme and which may be granted under the Share Option Scheme, during the period commencing on the date of the Hong Kong Underwriting Agreement and ending on, and including, the date which is six months after the Listing Date (the “**First Six-Month Period**”), our Company will not, and will procure that the subsidiaries of our Company will not, without the prior written consent of the Joint Sponsors and the Sole Global Coordinator (for itself and on behalf of the Hong Kong Underwriters) and unless in compliance with the requirements of the Listing Rules:

- (a) allot, issue, sell, accept subscription for, offer to allot, issue or sell, contract or agree to allot, issue or sell, mortgage, charge, pledge, hypothecate, lend, grant or sell any option, warrant, contract or right to subscribe for or purchase, grant or purchase any option, warrant, contract or right to allot, issue or sell, or otherwise transfer or dispose of or create an encumbrance over, or agree to transfer or dispose of or create an encumbrance over, either directly or indirectly, conditionally or unconditionally, any Shares or any other securities of our Company or any shares or other securities of such other member of our Group, as applicable, or any interest in any of the foregoing (including, without limitation, any securities convertible into or exchangeable or exercisable for or that represent the right to receive, or any warrants or other rights to purchase, any Shares or any shares of such other member of our Group, as applicable); or
- (b) enter into any swap or other arrangement that transfers to another, in whole or in part, any of the economic consequences of ownership of Shares or any other securities of our Company or any shares or other securities of such other member of our Group, as applicable, or any interest in any of the foregoing (including, without limitation, any securities convertible into or exchangeable or exercisable for or that represent the right to receive, or any warrants or other rights to purchase, any Shares or any shares of such other member of our Group, as applicable); or
- (c) enter into any transaction with the same economic effect as any transaction described in paragraphs (a) and (b) above; or
- (d) offer to or agree to or announce any intention to effect as any transaction described in paragraphs (a), (b) and (c) above,

in each case, whether any of the foregoing transactions is to be settled by delivery of the Shares or such other securities of our Company or shares or other securities of such other member of our Group, as applicable, or in cash or otherwise (whether or not such issue of the Shares or securities will be completed within such period). In the event of our Company

UNDERWRITING

doing any of the foregoing by virtue of the aforesaid exceptions or during the period of six months immediately following the expiry of the First Six-Month Period (the “**Second Six-Month Period**”), our Company will take all reasonable steps to ensure that any such act will not create a disorderly or false market in the securities of our Company. Our Controlling Shareholders undertake to each of the Sole Global Coordinator, the Joint Sponsors, the Joint Bookrunners, the Joint Lead Managers and the Hong Kong Underwriters to procure our Company to comply with the undertakings set out above.

By our Controlling Shareholders

Each of our Controlling Shareholders has undertaken to each of our Company, the Sole Global Coordinator, the Joint Sponsors, the Joint Bookrunners, the Joint Lead Managers and the Hong Kong Underwriters that, save as pursuant to the Stock Borrowing Agreement, without the prior written consent of the Sole Global Coordinator (for itself and on behalf of the Hong Kong Underwriters) and unless in compliance with the requirements of the Listing Rules:

- (a) he/it will not, and will procure that none of the relevant registered shareholder(s) will, during the First Six-Month Period: (i) sell, offer to sell, contract or agree to sell, mortgage, charge, pledge, hypothecate, lend, grant or sell any option, warrant, contract or right to purchase, grant or purchase any option, warrant, contract or right to sell, or otherwise transfer or dispose of or create an encumbrance over, or agree to transfer or dispose of or create an encumbrance over, either directly or indirectly, conditionally or unconditionally, any Shares or any other securities of our Company or any interest therein (including, without limitation, any securities convertible into or exchangeable or exercisable for or that represent the right to receive, or any warrants or other rights to purchase, any Shares, as applicable); or (ii) enter into any swap or other arrangement that transfers to another, in whole or in part, any of the economic consequences of ownership of the Shares or any other securities of our Company or any interest therein (including, without limitation, any securities convertible into or exchangeable or exercisable for or that represent the right to receive, or any warrants or other rights to purchase, any Shares) or (iii) enter into any transaction with the same economic effect as any transaction specified in item (i) or (ii) above; or (iv) offer to or agree to or announce any intention to effect any transaction specified in item (i), (ii) or (iii) above, in each case, whether any of the transactions specified in item (i), (ii) or (iii) above is to be settled by delivery of the Shares or such other securities of our Company or in cash or otherwise (whether or not the issue of Shares or such other securities will be completed within the aforesaid period);

UNDERWRITING

- (b) he/it will not and, will procure that none of the relevant registered shareholder(s) will, during the Second Six-Month Period, enter into any of the transactions specified in item (i), (ii) or (iii) in paragraph (a) above or offer to or agree to or announce any intention to effect any such transaction if, immediately following any sale, transfer or disposal or upon the exercise or enforcement of any option, right, interest or encumbrance pursuant to such transaction, it will cease to be a Controlling Shareholder of our Company;
- (c) until the expiry of the Second Six-Month Period, in the event that he/it enters into any of the transactions specified in item (i), (ii) or (iii) in paragraph (a) above or offers to or agrees to or announces any intention to effect any such transaction, he/it will take all reasonable steps to ensure that such transaction, agreement or announcement, as the case may be, will not create a disorderly or false market in the securities of our Company; and
- (d) he/it shall, and shall procure that his/its respective associates and companies controlled by him/it and any nominee or trustees holding in trust for him/it shall, comply with all the restrictions and requirements under the Listing Rules on the sale, transfer or disposal by him/it or by the registered holder controlled by him/it of any Shares.

International Offering

In connection with the International Offering, it is expected that our Company will enter into the International Underwriting Agreement with, *inter alia*, the International Underwriters. Under the International Underwriting Agreement, the International Underwriters will, subject to certain conditions, severally agree to subscribe or buy or procure subscribers or purchasers to subscribe for the International Offer Shares being offered pursuant to the International Offering.

Our Company is expected to grant to the Sole Global Coordinator the Over-allotment Option, exercisable by the Sole Global Coordinator (for itself and on behalf of the International Underwriters) at any time from the date of the International Underwriting Agreement until 30 days from the date of the last day of lodging applications under the Hong Kong Public Offering to require our Company to allot and issue up to an aggregate of 35,880,000 additional Shares, representing 15.0% of the initial Offer Shares in aggregate, at the same price per Share under the International Offering to cover, among other things, over-allocations (if any) in the International Offering.

Underwriting Commission and Expenses

The Underwriters are expected to receive a commission of 2.8% of the Offer Price of all the Offer Shares (including any Shares to be issued pursuant to the Over-allotment Option), out of which they will pay any sub-underwriting commission. Such commission payable to the Underwriters, together with the Hong Kong Stock Exchange listing fees, the Hong Kong Stock Exchange trading fee, the SFC transaction levy, legal and other professional fees, printing and other expenses relating to the Global Offering, is currently estimated to be approximately HK\$45.7 million in aggregate (based on an Offer Price of HK\$1.84 per

UNDERWRITING

Share, being the mid-point of the indicative Offer Price range of HK\$1.50 to HK\$2.19 per Share, and on the assumption that the Over-allotment Option is not exercised) and will be paid by our Company, save for such underwriting commissions, fees and expenses relating to the sale of the Sale Shares by the Selling Shareholder which will be borne by the Selling Shareholder.

The Selling Shareholder will pay underwriting commission, brokerage, SFC transaction levy and Hong Kong Stock Exchange trading fee and any stamp or capital duty (if any) or premium duty (if any) in respect of the Sale Shares.

In addition, our Company may, at our sole discretion, pay a discretionary bonus of up to 1.0% of the Offer Price of all the Offer Shares (excluding Sale Shares, the incentive fee for which will be borne by the Selling Shareholder (if any)) under the Global Offering to the Sole Global Coordinator, and a discretionary bonus to each of the Joint Bookrunners (other than the Sole Global Coordinator), in recognition of its services.

INDEMNITY

Each of our Company, the Controlling Shareholders, the Selling Shareholder and the executive Directors has agreed to indemnify the Hong Kong Underwriters and the Joint Sponsors against certain losses which the Hong Kong Underwriters may suffer, including losses arising from its performance of its obligations under the Hong Kong Underwriting Agreement and any breach by our Company and each of our Company, the Controlling Shareholders and the executive Directors of the Hong Kong Underwriting Agreement.

INDEPENDENCE OF THE JOINT SPONSORS

BOCI Asia Limited does not satisfy the independence criteria applicable to sponsors as set out in Rule 3A.07 of the Listing Rules because certain portion of the proceeds from the sale of Sale Shares by the Selling Shareholder (which amounts to 15% or more of the proceeds raised from the initial public offering of our Company) will be used directly or indirectly to settle debts due from the Selling Shareholder to Bank of China (Hong Kong) Limited, being a subsidiary of Bank of China Limited of which BOCI Asia Limited is a subsidiary, and therefore a member of the sponsor group (as defined in Rule 3A.01(9) of the Listing Rules).

BOSC International Company Limited satisfies the independence criteria applicable to sponsors as set out in Rule 3A.07 of the Listing Rules.

UNDERWRITERS' INTERESTS IN OUR COMPANY

Save for their obligations under the relevant Underwriting Agreements, none of the Underwriters has any shareholding in any member of our Group or any right (whether legally enforceable or not) to subscribe for or to nominate persons to subscribe for securities in any member of our Group.

UNDERWRITING

ACTIVITIES BY SYNDICATE MEMBERS

The Underwriters of the Global Offering (the “**Syndicate Members**”) and their affiliates are diversified financial institutions with relationships in countries around the world. These entities engage in a wide range of commercial and investment banking, brokerage, funds management, trading, hedging, investing and other activities for their own accounts and for the account of others. In relation to our Shares, other activities could include acting as agent for buyers and sellers of our Shares, entering into transactions with other buyers and sellers in a principal capacity, proprietary trading in our Shares, and entering into over-the-counter or listing derivative transactions or listed and unlisted securities transactions (including issuing securities such as derivative warrants listed on the Hong Kong Stock Exchange) which have as their underlying, assets including our Shares. Those activities may require hedging activity by those entities involving, directly or indirectly, buying and selling our Shares. All such activities could occur in Hong Kong and elsewhere in the world and may result in the Syndicate Members and their affiliates holding long and/or short positions in our Shares, in baskets of securities or indices including our Shares, in units of funds that may purchase our Shares, or in derivatives related to any of the foregoing.

In relation to issues by Syndicate Members or their affiliates of any listed securities having our Shares as their or part of their underlying assets, whether on the Hong Kong Stock Exchange or on any other stock exchange, the rules of the stock exchange may require the issuer of other securities (or one of its affiliates or agents) to act as a market maker or liquidity provider in the security, and these will also result in hedging activity in our Shares in most cases.

All these activities may occur both during and after the end of the stabilizing period described in “Structure of the Global Offering — Stabilizing Action” in this prospectus. These activities may affect the market price or value of our Shares, the liquidity or trading volume in our Shares, and the volatility of our Share price, and the extent to which this occurs from day to day cannot be estimated.

It should be noted that when engaging in any of these activities, the Syndicate Members will be subject to certain restrictions, including the following:

- (a) the Syndicate Members (other than the Stabilizing Manager or any person acting for it) must not, in connection with the distribution of the Offer Shares, effect any transactions (including issuing or entering into any option or other derivative transactions relating to the Offer Shares), whether in the open market or otherwise, with a view to stabilizing or maintaining the market price of any of the Offer Shares at levels other than those which might otherwise prevail in the open market; and
- (b) the Syndicate Members must comply with all applicable laws and regulations, including the market misconduct provisions of the SFO, including the provisions prohibiting insider dealing, false trading, price rigging and stock market manipulation.

STRUCTURE OF THE GLOBAL OFFERING

OFFER PRICE AND PRICE PAYABLE ON APPLICATION

The Offer Price will not be more than HK\$2.19 per Offer Share and is expected to be not less than HK\$1.50 per Offer Share. Applicants under the Hong Kong Public Offering should pay, on application, the maximum price of HK\$2.19 per Share plus 1.0% brokerage fee, 0.0027% SFC transaction levy and 0.005% Hong Kong Stock Exchange trading fee amounting to a total of HK\$4,424.14 for one board lot of 2,000 Shares.

If the Offer Price, as finally determined in the manner described below, is lower than HK\$2.19, being the maximum price, we will refund the respective difference (including the brokerage fee, the SFC transaction levy and the Hong Kong Stock Exchange trading fee attributable to the surplus application monies) to successful applicants, without interest. Further details are set out in the section headed “How to Apply for Hong Kong Offer Shares” in this prospectus.

DETERMINING THE OFFER PRICE

The Offer Price is expected to be determined by agreement between the Sole Global Coordinator (for itself and on behalf of the Underwriters) and our Company (for ourselves and on behalf of the Selling Shareholder) on or before the Price Determination Date, when market demand for the Offer Shares will be determined. The Price Determination Date is expected to be on or around Friday, May 4, 2018 and in any event, no later than Monday, May 7, 2018.

The Offer Price will not be more than HK\$2.19 per Offer Share and is expected to be not less than HK\$1.50 per Offer Share. The Offer Price will be determined within the Offer Price range as stated in this prospectus unless otherwise announced, as further explained below, not later than the morning of the last day for lodging applications under the Hong Kong Public Offering. Prospective investors should be aware that the Offer Price to be determined on the Price Determination Date may be, but is not expected to be, lower than the indicative Offer Price range stated in this prospectus.

The Sole Global Coordinator, on behalf of the Underwriters, may, where considered appropriate, based on the level of interest expressed by prospective professional, institutional, corporate and other investors during the book-building process, and with the consent of our Company (for ourselves and on behalf of the Selling Shareholder), reduce the number of Offer Shares and/or the indicative Offer Price range below that stated in this prospectus at any time prior to the morning of the last day for lodging applications under the Hong Kong Public Offering. In such a case, we will, as soon as practicable following the decision to make such reduction, and in any event not later than the morning of the last day for lodging applications under the Hong Kong Public Offering, cause to be published on the website of the Hong Kong Stock Exchange at www.hkexnews.hk and our website at www.twcoffee.com notices of the reduction in the number of Offer Shares and/or the indicative Offer Price range. Upon issue of such a notice, the revised number of Offer Shares and/or Offer Price range will be final and conclusive and the Offer Price, if agreed upon with us, will be fixed within such revised Offer Price range. Such notice will also

STRUCTURE OF THE GLOBAL OFFERING

include confirmation or revision, as appropriate, of the working capital statement, the offering statistics as currently set out in the section headed “Summary” in this prospectus and any other financial information which may change materially as a result of such reduction.

In the absence of any notice being published on the website of the Hong Kong Stock Exchange at www.hkexnews.hk and our website at www.twcoffee.com of a reduction in the number of Offer Shares and/or the indicative Offer Price range stated in this prospectus on or before the morning of the last day for lodging applications under the Hong Kong Public Offering, the number of Offer Shares and/or the Offer Price, if agreed by us, will under no circumstances be fewer than the number of Offer Shares or be set outside the Offer Price range as stated in this prospectus.

If we are unable to reach agreement with the Sole Global Coordinator (for itself and on behalf of the Underwriters) on the Offer Price on or before Friday, May 4, 2018, being the Price Determination Date, and, in any event, no later than Monday, May 7, 2018, the Global Offering will not become unconditional and will lapse immediately.

We expect to publish an announcement of the Offer Price, together with the level of interest in the International Offering and the results of application and basis of allotment of the Hong Kong Offer Shares, on Thursday, May 10, 2018.

THE GLOBAL OFFERING

This prospectus is published in connection with the Hong Kong Public Offering as part of the Global Offering. The Global Offering comprises:

- (i) the Hong Kong Public Offering of 23,920,000 Offer Shares (subject to adjustment as mentioned below and including 2,392,000 Employee Reserved Shares) for subscription by the public in Hong Kong as described in the section headed “— The Hong Kong Public Offering” below; and
- (ii) the International Offering of 215,280,000 Offer Shares (comprising 82,309,312 new Shares and 132,970,688 Sale Shares to be offered by the Selling Shareholder, and subject to adjustment and the Over-allotment Option as mentioned below) outside the United States (including with professional, institutional and corporate investors and other investors who we anticipate to have a sizeable demand for the Offer Shares in Hong Kong) in offshore transactions in reliance on Regulation S.

Investors may apply for our Offer Shares under the Hong Kong Public Offering or indicate an interest, if qualified to do so, in our Offer Shares under the International Offering, but may not do both. The Hong Kong Public Offering is open to members of the public in Hong Kong as well as to institutional and professional investors in Hong Kong. In particular, under the Employee Preferential Offering which forms part of the Hong Kong Public Offering, Eligible Employees may make an application for the Employee Reserved Shares on a **PINK** Application Form, and will be entitled to apply for Hong Kong Offer

STRUCTURE OF THE GLOBAL OFFERING

Shares under the Hong Kong Public Offering. The International Offering will involve selective marketing of our Shares to professional, institutional, corporate and other investors anticipated to have a sizeable demand for such Shares. Professional investors generally include brokers, dealers, companies (including fund managers) whose ordinary business involves dealing in shares and other securities and corporate entities which regularly invest in shares and other securities. Prospective professional, institutional, corporate and other investors will be required to specify the number of our Shares under the International Offering they would be prepared to acquire either at different prices or at a particular price. This process, known as “book-building”, is expected to continue up to the Price Determination Date.

Allocation of our Shares pursuant to the International Offering will be determined by the Sole Global Coordinator and will be based on a number of factors including the level and timing of demand, total size of the relevant investor’s invested assets or equity assets in the relevant sector and whether or not it is expected that the relevant investor is likely to buy further, and/or hold or sell, Shares, after the Listing. Such allocation is intended to result in a distribution of Shares on a basis which would lead to the establishment of a solid professional and institutional shareholder base to the benefit of our Company and our Shareholders as a whole.

Allocation of Hong Kong Offer Shares to investors under the Hong Kong Public Offering will be based solely on the level of valid applications received under the Hong Kong Public Offering. The basis of allocation may vary, depending on the number of Hong Kong Offer Shares validly applied for by applicants, although the allocation of Hong Kong Offer Shares could, where appropriate, consist of balloting, which would mean that some applicants may receive a higher allocation than others who have applied for the same number of Hong Kong Offer Shares, and those applicants who are not successful in the ballot may not receive any Hong Kong Offer Shares.

For allocation purposes only, the total number of Hong Kong Offer Shares available under the Hong Kong Public Offering (after taking into account any reallocation referred to below and after deducting the number of Employee Reserved Shares validly applied for under the Employee Preferential Offering) will be divided equally (to the nearest board lot) into two pools: pool A and pool B. Assuming all the Employee Reserved Shares are validly subscribed for and allocated to applicants under the **PINK** Application Forms, pool A will comprise 10,764,000 Hong Kong Offer Shares and pool B will comprise 10,764,000 Hong Kong Offer Shares, both of which are available on an equitable basis to applicants. All valid applications that have been received for the Hong Kong Offer Shares with a total price (excluding brokerage fee, SFC transaction levy and Hong Kong Stock Exchange trading fee) of HK\$5 million or below will fall into pool A and all valid applications that have been received for the Hong Kong Offer Shares with a total price (excluding brokerage fee, SFC transaction levy and Hong Kong Stock Exchange trading fee) of over HK\$5 million and up to the total value of pool B, will fall into pool B.

If the Employee Reserved Shares are not fully taken up, any excess Employee Reserved Shares will be reallocated to pool A and pool B in equal proportions.

STRUCTURE OF THE GLOBAL OFFERING

Investors should be aware that applications in pool A and applications in pool B may receive different allocation ratios. If any Hong Kong Offer Shares in one (but not both) of the pools are unsubscribed, such unsubscribed Hong Kong Offer Shares will be transferred to the other pool to satisfy demand in that other pool and be allocated accordingly. For the purpose of the immediately preceding paragraph only, the “price” for Hong Kong Offer Shares means the price payable on application therefor (without regard to the Offer Price as finally determined). Applicants can only receive an allocation of Hong Kong Offer Shares from either pool A or pool B and not from both pools. Multiple or suspected multiple applications under the Hong Kong Public Offering and any application for more than 10,764,000 Hong Kong Offer Shares (being 50% of the 21,528,000 Shares initially available under the Hong Kong Public Offering but excluding the Employee Reserved Shares) are liable to be rejected.

In connection with the Global Offering, we intend to grant the Over-allotment Option to the International Underwriters pursuant to the International Underwriting Agreement, exercisable by the Sole Global Coordinator on behalf of the International Underwriters. The Over-allotment Option gives the Sole Global Coordinator the right exercisable at any time from the date of the International Underwriting Agreement up to the thirtieth day from the last day for the lodging of applications under the Hong Kong Public Offering to require us to sell up to an aggregate of 35,880,000 additional Shares, representing 15.0% of the initial size of the Global Offering at the Offer Price solely to cover over-allocations in the International Offering if any. The Sole Global Coordinator may also cover such over-allocations by purchasing the Offer Shares in the secondary market or by a combination of purchases in the secondary market and a partial exercise of the Over-allotment Option. Any such secondary market purchase will be made in compliance with all applicable laws, rules and regulations. In the event that the Over-allotment Option is exercised, a public announcement will be made. For further details, please refer to the paragraph headed “— The Over-allotment Option” in this section.

The Hong Kong Public Offering is fully underwritten by the Hong Kong Underwriters and the International Offering is expected to be fully underwritten by the International Underwriters in each case on a several basis, each being subject to the conditions set out under “— Conditions of the Hong Kong Public Offering” in this section. We entered into the Hong Kong Underwriting Agreement and, subject to an agreement on the Offer Price between us (for ourselves and on behalf of the Selling Shareholder) and the Sole Global Coordinator (for itself and on behalf of the Underwriters), we expect to enter into the International Underwriting Agreement on or around May 4, 2018. The Hong Kong Underwriting Agreement and the International Underwriting Agreement are expected to be conditional upon each other.

STRUCTURE OF THE GLOBAL OFFERING

THE HONG KONG PUBLIC OFFERING

The Hong Kong Public Offering is a fully underwritten public offer (subject to agreement as to pricing and satisfaction or waiver of the other conditions set out in the Hong Kong Underwriting Agreement) for the subscription in Hong Kong of initially 23,920,000 Shares (representing 10.0% of the total number of Shares initially available under the Global Offering) at the Offer Price. Of the 23,920,000 Shares being initially offered under the Hong Kong Public Offering, up to 2,392,000 Shares (representing 10% of the total number of the Hong Kong Offer Shares being initially offered) are available for subscription by the Eligible Employees on a preferential basis under the Employee Preferential Offering, subject to the terms and conditions set out in this prospectus and the PINK Application Forms. Subject to the reallocation of Shares between the International Offering and the Hong Kong Public Offering, the Hong Kong Offer Shares will represent 3.3% of our Company's enlarged issued share capital immediately after completion of the Global Offering (without taking into account any Shares which may be allotted and issued upon the exercise of the Over-allotment Option and the options which have been granted under the Pre-IPO Share Option Scheme or which may be granted under the Share Option Scheme).

The Offer Shares to be offered in the Hong Kong Public Offering and the International Offering may, in certain circumstances, be reallocated as between these offerings at the sole discretion of the Sole Global Coordinator.

The allocation of the Offer Shares between the Hong Kong Public Offering and the International Offering is subject to reallocation on the following basis:

- (a) Where the International Offer Shares are fully subscribed or oversubscribed:
 - (i) if the Offer Shares for the Hong Kong Public Offering are undersubscribed, the Sole Global Coordinator will have the discretion (but shall not be under any obligation) to reallocate all or any unsubscribed Offer Shares for the Hong Kong Public Offering to the International Offering, in such proportions as the Sole Global Coordinator deems appropriate;
 - (ii) if the number of Offer Shares validly applied for under the Hong Kong Public Offering represents less than 15 times of the number of the Offer Shares initially available for subscription under the Hong Kong Public Offering, then 23,920,000 Offer Shares may be reallocated to the Hong Kong Public Offering from the International Offering so that the total number of the Offer Shares available under the Hong Kong Public Offering will be 47,840,000 Offer Shares, representing 20% of the number of the Offer Shares initially available under the Global Offering (before any exercise of the Over-allotment Option);

STRUCTURE OF THE GLOBAL OFFERING

- (iii) if the number of Offer Shares validly applied for under the Hong Kong Public Offering represents 15 times or more but less than 50 times the number of the Offer Shares initially available for subscription under the Hong Kong Public Offering, then 47,840,000 Shares will be reallocated to the Hong Kong Public Offering from the International Offering, so that the total number of the Offer Shares available under the Hong Kong Public Offering will be increased to 71,760,000 Offer Shares, representing 30% of the number of the Offer Shares initially available under the Global Offering (before any exercise of the Over-allotment Option);
 - (iv) if the number of Offer Shares validly applied for under the Hong Kong Public Offering represents 50 times or more but less than 100 times the number of the Offer Shares initially available for subscription under the Hong Kong Public Offering, then 71,760,000 Offer Shares will be reallocated to the Hong Kong Public Offering from the International Offering, so that the number of the Offer Shares available under the Hong Kong Public Offering will be increased to 95,680,000 Offer Shares, representing 40% of the number of the Offer Shares initially available under the Global Offering (before any exercise of the Over-allotment Option); and
 - (v) if the number of Offer Shares validly applied for under the Hong Kong Public Offering represents 100 times or more the number of the Offer Shares initially available for subscription under the Hong Kong Public Offering, then 95,680,000 Shares will be reallocated to the Hong Kong Public Offering from the International Offering, so that the number of the Offer Shares available under the Hong Kong Public Offering will be increased to 119,600,000 Offer Shares, representing 50% of the number of the Offer Shares initially available under the Global Offering (before any exercise of the Over-allotment Option).
- (b) Where the International Offer Shares are undersubscribed:
- (i) if the Offer Shares for Hong Kong Public Offering are undersubscribed, the Global Offering will not proceed unless the Underwriters would subscribe or procure subscribers for their respective applicable proportions of the Offer Shares being offered which are not taken up under the Global Offering on the terms and conditions of this prospectus, the Application Forms and the Underwriting Agreements; and

STRUCTURE OF THE GLOBAL OFFERING

- (ii) if the Offer Shares for Hong Kong Public Offering are oversubscribed irrespective of the number of times the number of Offer Shares initially available for subscription under the Hong Kong Public Offering, then up to 23,920,000 Offer Shares may be reallocated to the Hong Kong Public Offering from the International Offering, so that the total number of the Offer Shares available under the Hong Kong Public Offering will be increased to 47,840,000 Offer Shares, representing 20% of the number of the Offer Shares initially available under the Global Offering (before any exercise of the Over-allotment Option).

In the event of reallocation of Offer Shares between the Hong Kong Public Offering and the International Offering in the circumstances where the International Offer Shares are fully subscribed or oversubscribed and the Offer Shares for the Hong Kong Public Offering are oversubscribed by less than 15 times under paragraph (a)(ii) above or the International Offer Shares are undersubscribed and the Offer Shares for the Hong Kong Public Offering are oversubscribed under paragraph (b)(ii) above, the final Offer Price shall be fixed at the bottom end of the indicative Offer Price range (i.e. HK\$1.50 per Offer Share) stated in this prospectus.

In the event of reallocation of Offer Shares from the International Offering to the Hong Kong Public Offering in circumstances under paragraph (a)(ii), (a)(iii), (a)(iv), (a)(v) and (b)(ii) above, the number of Offer Shares allocated to the International Offering will be correspondingly reduced.

The Employee Preferential Offering will not be subject to reallocation between the Hong Kong Public Offering and the International Offering.

References in this prospectus to applications, Application Forms, application or subscription monies or the procedure for application relate solely to the Hong Kong Public Offering.

STRUCTURE OF THE GLOBAL OFFERING

CONDITIONS OF THE HONG KONG PUBLIC OFFERING

Acceptance of all applications for the Offer Shares pursuant to the Hong Kong Public Offering will be conditional on:

- (a) the Listing Committee of the Hong Kong Stock Exchange granting listing of, and permission to deal in, our Shares in issue and to be issued pursuant to the Global Offering (including any Shares which may be issued pursuant to the exercise of the Over-allotment Option, the options granted under the Pre-IPO Share Option Scheme and any options which may be granted under the Share Option Scheme) and such listing and permission not subsequently having been revoked prior to the commencement of dealings in our Shares on the Hong Kong Stock Exchange;
- (b) the Offer Price having been duly agreed between us (for ourselves and on behalf of the Selling Shareholder) and the Sole Global Coordinator (for itself and on behalf of the Underwriters);
- (c) the execution and delivery of the International Underwriting Agreement on or around the Price Determination Date; and
- (d) the obligations of the Underwriters under each of the respective Underwriting Agreements becoming and remaining unconditional (including, if relevant, as a result of the waiver of any conditions by the Sole Global Coordinator, for itself and on behalf of the Underwriters) and such obligations not being terminated in accordance with the terms of the respective Underwriting Agreements,

in each case, on or before the dates and times specified in the respective Underwriting Agreements (unless and to the extent such conditions are validly waived on or before such dates and times) and in any event not later than 30 days after the date of this prospectus.

The consummation of the Hong Kong Public Offering is conditional upon, among other things, the International Offering and the Hong Kong Public Offering becoming unconditional and not having been terminated in accordance with their respective terms.

If the above conditions are not fulfilled or waived prior to the times and dates specified, the Global Offering will lapse and we will notify the Hong Kong Stock Exchange immediately. We will publish or cause to be published a notice of the lapse of the Hong Kong Public Offering on the website of the Hong Kong Stock Exchange at www.hkexnews.hk and our website at www.twcoffee.com on the next day following such lapse.

In case the Hong Kong Public Offering lapses, we will return all application monies to the applicants, without interest and on the terms set out under “How to Apply for Hong Kong Offer Shares” in this prospectus. In the meantime, we will hold all application monies in a separate bank account or separate bank accounts with the receiving banker(s) or other bank(s) licenced under the Banking Ordinance (Chapter 155 of the Laws of Hong Kong) (as amended).

STRUCTURE OF THE GLOBAL OFFERING

EMPLOYEE PREFERENTIAL OFFERING

Up to 2,392,000 Employee Reserved Shares (representing 10% of the total number of Hong Kong Offer Shares being initially offered under the Hong Kong Public Offering) are available for subscription by the Eligible Employees on a preferential basis. Our Directors and directors of any of our subsidiaries and their respective affiliates shall not apply for Employee Reserved Shares under the Employee Preferential Offering and shall not apply for Hong Kong Offer Shares as members of the public in the Hong Kong Public Offering. All Eligible Employees may apply for Hong Kong Offer Shares in the Hong Kong Public Offering and Employee Reserved Shares in the Employee Preferential Offering. Such Eligible Employees will receive no preference as to entitlement or allocation in respect of such further applications for the Hong Kong Offer Shares under the Hong Kong Public Offering. For further details, please see the section headed “How to Apply for the Hong Kong Offer Shares” in this prospectus.

In case not all the 2,392,000 Employee Reserved Shares are validly subscribed for by the Eligible Employees, the undersubscribed Employee Reserved Shares will be available as the Hong Kong Offer Shares for subscription by the public under the Hong Kong Public Offering.

The 2,392,000 Employee Reserved Shares available for application by Eligible Employees on **PINK** Application Forms will be allocated to such applicants on a basis to be determined by our Hong Kong Share Registrar based on the level of valid applications received under the Employee Preferential Offering and the number of Employee Reserved Shares validly applied for within each application tier. The allocation basis will be consistent with the allocation basis commonly used in the case of oversubscriptions in public offering in Hong Kong, where a higher allocation percentage will be applied in respect of smaller applications. The Employee Reserved Shares will be balloted if there are insufficient Employee Reserved Shares available to **PINK** Application Form applicants. If balloting is conducted, one or more Eligible Employee(s) may be allocated more Employee Reserved Shares than others who have applied for the same number of Employee Reserved Shares, and those Eligible Employees who have applied for Employee Reserved Shares and who are not successful in the ballot may not receive any Employee Reserved Shares.

The allocation of Employee Reserved Shares to Eligible Employees will in any event be made on an equitable basis and will not be based on the identity, seniority, work performance or length of service of the Eligible Employees. No favour will be given to the Eligible Employees who apply for a large number of Employee Reserved Shares. Any application made on a **PINK** Application Form for more than 2,392,000 Employee Reserved Shares will be rejected. Allocation of Employee Reserved Shares under the Employee Preferential Offering will be based on the allocation guidelines contained in Practice Note 20 to the Listing Rules.

THE INTERNATIONAL OFFERING

The number of Offer Shares to be initially offered for subscription or purchase under the International Offering will be 215,280,000 Offer Shares (comprising 82,309,312 new Shares and 132,970,688 Sale Shares to be offered by our Selling Shareholder, subject to

STRUCTURE OF THE GLOBAL OFFERING

adjustment and the Over-allotment Option), representing 90% of the Offer Shares initially available under the Global Offering. The Hong Kong Underwriting Agreement and the International Underwriting Agreement are expected to be conditional upon each other.

Pursuant to the International Offering, the International Offer Shares will be conditionally placed by the International Underwriters, or through selling agents appointed by them, with professional, institutional, corporate and other investors anticipated to have a sizeable demand for Shares in Hong Kong and other jurisdictions outside the United States in reliance on Regulation S.

The Sole Global Coordinator (for itself and on behalf of the Underwriters) may require any investor who has been offered Offer Shares under the International Offering and who has made an application under the Hong Kong Public Offering to provide sufficient information to the Sole Global Coordinator so as to allow it to identify the relevant applications under the Hong Kong Public Offering and to ensure that such investor is excluded from any application of the Offer Shares under the Hong Kong Public Offering.

THE OVER-ALLOTMENT OPTION

In connection with the Global Offering, we intend to grant the Over-allotment Option to the Sole Global Coordinator on behalf of the International Underwriters. The Over-allotment Option gives the Sole Global Coordinator the right exercisable at any time from the date of the International Underwriting Agreement until 30 days from the last day for the lodging of applications under the Hong Kong Public Offering to require us to sell up to an aggregate of 35,880,000 additional Shares, representing 15.0% of the initial size of the Global Offering at the Offer Price solely to cover over-allocations in the International Offering, if any. The Sole Global Coordinator may also cover such over-allocations by purchasing Shares in the secondary market or by a combination of purchase in the secondary market and a partial exercise of the Over-allotment Option. Any such secondary market purchase will be made in compliance with all applicable laws, rules and regulations. If the Sole Global Coordinator exercises the Over-allotment Option in full, the additional Shares will represent approximately 4.7% of our enlarged share capital following the completion of the Global Offering (without taking into account any Shares which may be allotted and issued upon the exercise of the options which have been granted under the Pre-IPO Share Option Scheme or which may be granted under the Share Option Scheme). In the event that the Over-allotment Option is exercised, a public announcement will be made.

In order to facilitate settlement of over-allocations in connection with the International Offering, Hero Valour and the Stabilizing Manager will enter into the Stock Borrowing Agreement. Under the Stock Borrowing Agreement, Hero Valour will agree with the Stabilizing Manager that, if requested by the Stabilizing Manager, it will, subject to the terms of the Stock Borrowing Agreement, make available to the Stabilizing Manager up to 35,880,000 Shares held by Hero Valour by way of stock lending, in order to cover over-allocations in connection with the International Offering.

The Stock Borrowing Agreement, in compliance with Rule 10.07(3) of the Listing Rules, provides that such stock borrowing arrangement will only be effected by the Stabilizing Manager for the purpose of settling over-allocations of Shares in connection

STRUCTURE OF THE GLOBAL OFFERING

with the International Offering and covering any short position prior to the exercise of the Over-allotment Option. The maximum number of Shares to be borrowed from Hero Valour under the Stock Borrowing Agreement will be limited to the maximum number of Shares which may be issued upon exercise of the Over-allotment Option. The same number of Shares so borrowed is to be returned to Hero Valour or its nominee(s), as the case may be, not later than the third business day following the earlier of (i) the day on which the Over-allotment Option is exercised in full, or (ii) the last day on which the Over-allotment Option may be exercised by the Stabilizing Manager. The stock borrowing arrangement under the Stock Borrowing Agreement will be effected in compliance with all applicable laws, rules and regulatory requirements. No payments or other benefits will be made to Hero Valour by the Stabilizing Manager or any of the International Underwriters in relation to such stock borrowing arrangement.

STABILIZING ACTION

Stabilization is a practice used by underwriters in some markets to facilitate the distribution of securities. To stabilise, the underwriters may bid for, or purchase, the newly issued securities in the secondary market, during a specified period of time, to minimise and, if possible, prevent a decline in the initial public offer prices. In Hong Kong and certain other jurisdictions, the price at which stabilization is effected is not permitted to exceed the Offer Price.

In connection with the Global Offering, the Stabilizing Manager, or any person acting for it, on behalf of the Underwriters, may, to the extent permitted by applicable laws, rules and regulations of Hong Kong, over-allocate or any effect transactions with a view to stabilizing or maintaining the market price of our Shares at a level higher than that which might otherwise prevail in the open market for a limited period commencing after the last day of the lodging of applications under the Hong Kong Public Offering. Such transactions may be effected in all jurisdictions where it is permissible to do so, in each case in compliance with all applicable laws and regulatory requirements. However, there is no obligation on the Stabilizing Manager or any person acting for it to conduct any stabilizing activity. Such stabilization, if commenced, will be conducted at the absolute discretion of the Stabilizing Manager or any person acting for it and may be discontinued at any time, and must be brought to an end within 30 days of the last day for the lodging of applications under the Hong Kong Public Offering. The number of Shares that may be over-allocated will not be greater than the number of Shares which may be sold upon exercise of the Over-allotment Option, being 35,880,000 Shares, which represents 15.0% of the Shares initially available under the Global Offering.

The Stabilizing Manager or any person acting for it may take all or any of the following stabilizing actions in Hong Kong during the stabilization period:

- (i) purchase, or agree to purchase, any of our Shares or offer or attempt to do so for the sole purpose of preventing or minimising any reduction in the market price of our Shares; and/or

STRUCTURE OF THE GLOBAL OFFERING

- (ii) in connection with any action described in paragraph (i) above:
 - (A) (1) over-allocate our Shares; or
 - (2) sell or agree to sell our Shares so as to establish a short position in them, for the sole purpose of preventing or minimising any reduction in the market price of our Shares;
 - (B) stock borrowing;
 - (C) exercise the Over-allotment Option and purchase or subscribe for or agree to purchase or subscribe for our Shares in order to close out any position established under paragraph (A) above;
 - (D) sell or agree to sell any of our Shares acquired by it in the course of the stabilizing action referred to in paragraph (i) above in order to liquidate any position that has been established by such action; and/or
 - (E) offer or attempt to do anything as described in paragraph (ii)(A)(2), (ii)(B), (ii)(C) or (ii)(D) above.

The Stabilizing Manager, or any person acting for it, may, in connection with the stabilizing action, maintain a long position in the Shares, and there is no certainty as to the extent to which and the time period for which it will maintain such a position. Investors should be warned of the possible impact of any liquidation of the long position by the Stabilizing Manager or any person acting for it, which may include a decline in the market price of our Shares. Stabilization cannot be used to support the price of our Shares for longer than the stabilization period, which begins on the day on which dealings in our Shares commence on the Hong Kong Stock Exchange and ends on the thirtieth day after the last day for the lodging of applications under the Hong Kong Public Offering. After this date, when no further stabilizing action may be taken, demand for our Shares, and therefore their market price, could fall. A public announcement will be made within seven days after the end of the stabilizing period in accordance with the Securities and Futures (Price Stabilizing) Rules of the SFO.

Any stabilizing action taken by the Stabilizing Manager, or any person acting for it, may not necessarily result in the market price of our Shares staying at or above the Offer Price either during or after the stabilization period. Stabilization bids or market purchases effected in the course of the stabilizing action may be made at any price at or below the Offer Price and can therefore be done at a price below the price investors have paid in acquiring our Shares.

DEALING

Assuming that the Hong Kong Public Offering becomes unconditional at or before 8:00 a.m. in Hong Kong on Friday, May 11, 2018, it is expected that dealings in our Shares on the Hong Kong Stock Exchange will commence at 9:00 a.m. on Friday, May 11, 2018. The Shares will be traded on the Main Board in board lots size of 2,000 Shares each.

STRUCTURE OF THE GLOBAL OFFERING

UNDERWRITING ARRANGEMENTS

The Hong Kong Public Offering is fully underwritten by the Hong Kong Underwriters under the terms of the Hong Kong Underwriting Agreement, subject to agreement on the Offer Price between the Sole Global Coordinator (for itself and on behalf of the Underwriters) and us (for ourselves and on behalf of the Selling Shareholder) on the Price Determination Date and subject to the other conditions set out in the paragraph headed “Conditions of the Hong Kong Public Offering” above.

We expect, shortly after determination of the Offer Price on the Price Determination Date, to enter into the International Underwriting Agreement relating to the International Offering.

UNDERWRITING ARRANGEMENTS, THE HONG KONG UNDERWRITING AGREEMENT AND THE INTERNATIONAL UNDERWRITING AGREEMENT ARE SUMMARIZED IN THE SECTION HEADED “UNDERWRITING” IN THIS PROSPECTUS.

HOW TO APPLY FOR HONG KONG OFFER SHARES

1. HOW TO APPLY

If you apply for Hong Kong Offer Shares, then you may not apply for or indicate an interest for International Offer Shares.

To apply for Hong Kong Offer Shares, you may:

- use a **WHITE** or **YELLOW** Application Form;
- apply online via the **HK eIPO White Form** service at www.hkeipo.hk; or
- electronically cause HKSCC Nominees to apply on your behalf.

In addition, if you are an Eligible Employee, you may also apply for Employee Reserved Shares by using a **PINK** Application Form.

None of you or your joint applicant(s) may make more than one application, except where you are a nominee and provide the required information in your application.

Our Company, the Sole Global Coordinator, the **HK eIPO White Form** Service Provider and their respective agents may reject or accept any application in full or in part for any reason at their discretion.

2. WHO CAN APPLY

You can apply for Hong Kong Offer Shares on a **WHITE** or **YELLOW** Application Form if you or the person(s) for whose benefit you are applying:

- are 18 years of age or older;
- have a Hong Kong address;
- are outside the United States, and are not a United States Person (as defined in Regulation S under the U.S. Securities Act); and
- are not a legal or natural person of China.

You can also apply for Employee Reserved Shares by using a **PINK** Application Form if you satisfy the above criteria and you are also an Eligible Employee.

If you apply online through the **HK eIPO White Form** service, in addition to the above, you must also: (i) have a valid Hong Kong identity card number; and (ii) provide a valid e-mail address and a contact telephone number.

If you are a firm, the application must be in the individual members' names. If you are a body corporate, the Application Form must be signed by a duly authorized officer, who must state his representative capacity, and stamped with your corporation's chop.

HOW TO APPLY FOR HONG KONG OFFER SHARES

If an application is made by a person under a power of attorney, the Sole Global Coordinator may accept it at their discretion and on any conditions they think fit, including evidence of the attorney's authority.

The number of joint applicants may not exceed four and they may not apply by means of **HK eIPO White Form** service for the Hong Kong Offer Shares.

Unless permitted by the Listing Rules, you cannot apply for any Hong Kong Offer Shares if you:

- are an existing beneficial owner of shares in our Company and/or any of its subsidiaries;
- are a director or chief executive officer of our Company and/or any of its subsidiaries;
- are an associate (as defined in the Listing Rules) of any of the above;
- are a connected person (as defined in the Listing Rules) of our Company or will become a connected person of our Company immediately upon completion of the Global Offering; and
- have been allocated or have applied for any International Offer Shares or otherwise participate in the International Offering.

3. APPLYING FOR HONG KONG OFFER SHARES AND EMPLOYEE RESERVED SHARES

For Hong Kong Offer Shares to be issued in your own name, use a **WHITE** Application Form or apply online through www.hkeipo.hk.

For Hong Kong Offer Shares to be issued in the name of HKSCC Nominees and deposited directly into CCASS to be credited to your or a designated CCASS Participant's stock account, use a **YELLOW** Application Form or electronically instruct HKSCC via CCASS to cause HKSCC Nominees to apply for you.

If you are an Eligible Employee, and want the Hong Kong Offer Shares to be issued in your own name and want your application be given preferential treatment, use a **PINK** Application Form.

HOW TO APPLY FOR HONG KONG OFFER SHARES

Where to Collect the Application Forms

You can collect a **WHITE** Application Form and a prospectus during normal business hours from 9:00 a.m. on Monday, April 30, 2018 until 12:00 noon on Friday, May 4, 2018 from:

- (i) the following address of the Hong Kong Underwriters:

BOCI Asia Limited	26th Floor, Bank of China Tower, 1 Garden Road, Central, Hong Kong
DBS Asia Capital Limited	17th Floor, The Center, 99 Queen's Road Central Hong Kong
Kingsway Financial Services Group Limited	7/F, Tower One Lippo Centre 89 Queensway Hong Kong
Future Land Resources Securities Limited	Flat B, 20/F Guangdong Investment Tower 148 Connaught Road Central Sheung Wan Hong Kong
VBG Capital Limited	18/F, Prosperity Tower 39 Queen's Road Central Central, Hong Kong

- (ii) any of the designated branches of the following receiving banks:

Bank of China (Hong Kong) Limited

District	Branch Name	Address
Hong Kong Island	Bank of China Tower Branch	3/F, 1 Garden Road
	Wan Chai (Wu Chung House) Branch	213 Queen's Road East, Wan Chai
Kowloon	Kwun Tong Plaza Branch	G1 Kwun Tong Plaza, 68 Hoi Yuen Road, Kwun Tong
	Tsim Sha Tsui East Branch	Shop 3, LG/F, Hilton Towers, 96 Granville Road, Tsim Sha Tsui East, Kowloon
New Territories	Tai Po Branch	68-70 Po Heung Street, Tai Po Market

HOW TO APPLY FOR HONG KONG OFFER SHARES

District	Branch Name	Address
	Kau Yuk Road Branch	18–24 Kau Yuk Road, Yuen Long
	Tuen Mun San Hui Branch	G13–G14 Eldo Court, Heung Sze Wui Road, Tuen Mun

DBS Bank (Hong Kong) Limited

District	Branch Name	Address
Hong Kong Island	Head Office	G/F, The Center, 99 Queen's Road Central, Central
	Aberdeen Branch	Shops A & B, G/F, Units A & B, 1/F, On Tai Building, 1–3 Wu Nam Street, Aberdeen
Kowloon	Kowloon Bay — SME Banking Centre	Shop 6, G/F, Chevalier Commercial Centre, 8 Wang Hoi Road, Kowloon Bay
New Territories	Tuen Mun Town Plaza — SME Banking Centre	Shop 23, G/F, Tuen Mun Town Plaza (II), 3 Tuen Lung Street, Tuen Mun
	Kwai Chung Branch	G/F, 1001 Kwai Chung Road, Kwai Chung

You can collect a **YELLOW** Application Form and a prospectus during normal business hours from 9:00 a.m. on Monday, April 30, 2018 until 12:00 noon on Friday, May 4, 2018 from:

- the Depository Counter of HKSCC at 1/F, One & Two Exchange Square, 8 Connaught Place, Central, Hong Kong; or
- your stockbroker.

Eligible Employees can collect a **PINK** Application Form and a prospectus during normal business hours from 9:00 a.m. on Monday, April 30, 2018 until 12:00 noon on Thursday, May 3, 2018 from our Company's office at Flats F–J, 11th Floor, Block 1, Kwai Tak Industrial Centre, 15–33 Kwai Tak Street, Kwai Chung, New Territories, Hong Kong. Electronic copies of the **PINK** Application Form and this prospectus can be viewed from the website of the Company at www.twcoffee.com and the Hong Kong Stock Exchange's website at www.hkexnews.hk.

HOW TO APPLY FOR HONG KONG OFFER SHARES

Time for Lodging Application Forms

Your completed **WHITE** or **YELLOW** Application Form, together with a cheque or a banker's cashier order attached and marked payable to "**BANK OF CHINA (HONG KONG) NOMINEES LIMITED — TSIT WING PUBLIC OFFER**" for the payment, should be deposited in the special collection boxes provided at any of the branches of the receiving bank listed above, at the following times:

Monday, April 30, 2018	— 9:00 a.m. to 5:00 p.m.
Wednesday, May 2, 2018	— 9:00 a.m. to 5:00 p.m.
Thursday, May 3, 2018	— 9:00 a.m. to 5:00 p.m.
Friday, May 4, 2018	— 9:00 a.m. to 12:00 noon

The application lists will be open from 11:45 a.m. to 12:00 noon on Friday, May 4, 2018, the last application day or such later time as described in "10. Effect of Bad Weather on the Opening of the Application Lists" in this section.

Your completed **PINK** Application Form, together with a cheque or a banker's cashier order attached and marked payable to "**BANK OF CHINA (HONG KONG) NOMINEES LIMITED — TSIT WING PUBLIC OFFER**" for the payment must be deposited in the collection box located at our Company's office at Flats F–J, 11th Floor, Block 1, Kwai Tak Industrial Centre, 15–33 Kwai Tak Street, Kwai Chung, New Territories, Hong Kong by 12:00 noon on Thursday, May 3, 2018.

4. TERMS AND CONDITIONS OF AN APPLICATION

Follow the detailed instructions in the Application Form carefully; otherwise, your application may be rejected.

By submitting an Application Form or applying through the **HK eIPO White Form** service, among other things, you:

- (i) undertake to execute all relevant documents and instruct and authorize our Company and/or the Sole Global Coordinator (or its agents or nominees), as agents of our Company, to execute any documents for you and to do on your behalf all things necessary to register any Hong Kong Offer Shares allocated to you in your name or in the name of HKSCC Nominees as required by the Bye-Laws;
- (ii) agree to comply with the Companies (Winding Up and Miscellaneous Provisions) Ordinance, the Companies Ordinance and the Bye-Laws;
- (iii) confirm that you have read the terms and conditions and application procedures set out in this prospectus and in the Application Form and agree to be bound by them;

HOW TO APPLY FOR HONG KONG OFFER SHARES

- (iv) confirm that you have received and read this prospectus and have only relied on the information and representations contained in this prospectus in making your application and will not rely on any other information or representations except those in any supplement to this prospectus;
- (v) confirm that you are aware of the restrictions on the Global Offering in this prospectus;
- (vi) agree that none of our Company, the Selling Shareholder, the Joint Sponsors, the Sole Global Coordinator, the Joint Bookrunners, the Joint Lead Managers, the Underwriters, their respective directors, officers, employees, agents, affiliates or advisers or any other party involved in the Global Offering is or will be liable for any information and representations not in this prospectus (and any supplement to it);
- (vii) undertake and confirm that you or the person(s) for whose benefit you have made the application have not applied for or taken up, or indicated an interest for, and will not apply for or take up, or indicate an interest for, any Offer Shares under the International Offering nor participated in the International Offering;
- (viii) agree to disclose to our Company, the Selling Shareholder, the Hong Kong Share Registrar, receiving bank, the Joint Sponsors, the Sole Global Coordinator, the Joint Bookrunners, the Joint Lead Managers, the Underwriters and/or their respective directors, officers, employees, agents, affiliates or advisers or any other party involved in the Global Offering any personal data which they may require about you and the person(s) for whose benefit you have made the application;
- (ix) if the laws of any place outside Hong Kong apply to your application, agree and warrant that you have complied with all such laws and none of our Company, the Selling Shareholder, the Joint Sponsors, the Sole Global Coordinator, the Joint Bookrunners, the Joint Lead Managers and the Underwriters nor any of their respective directors, officers, employees, agents, affiliates or advisers or any other party involved in the Global Offering will breach any law outside Hong Kong as a result of the acceptance of your offer to purchase, or any action arising from your rights and obligations under the terms and conditions contained in this prospectus and the Application Form;
- (x) agree that once your application has been accepted, you may not rescind it because of an innocent misrepresentation;
- (xi) agree that your application will be governed by the laws of Hong Kong;

HOW TO APPLY FOR HONG KONG OFFER SHARES

- (xii) represent, warrant and undertake that (i) you understand that the Hong Kong Offer Shares have not been and will not be registered under the U.S. Securities Act; and (ii) you and any person for whose benefit you are applying for the Hong Kong Offer Shares are outside the United States (as defined in Regulation S) and are not a U.S. person (as defined in Regulation S);
- (xiii) warrant that the information you have provided is true and accurate;
- (xiv) agree to accept the Hong Kong Offer Shares applied for, or any lesser number allocated to you under the application;
- (xv) authorize our Company to place your name(s) or the name of the HKSCC Nominees, on our Company's register of members as the holder(s) of any Hong Kong Offer Shares allocated to you, and our Company (for ourselves and on behalf of the Selling Shareholder) and/or its agents to send any share certificate(s) and/or any e-Auto Refund payment instructions and/or any refund cheque(s) to you or the first-named applicant for joint application by ordinary post at your own risk to the address stated on the application, unless you have chosen to collect the share certificate(s) and/or refund cheque(s) in person;
- (xvi) declare and represent that this is the only application made and the only application intended by you to be made to benefit you or the person for whose benefit you are applying, except in respect of Employee Reserved Shares applied under the Employee Preferential Offering, if applicable;
- (xvii) declare and represent that this is the only application made and the only application intended by you to be made to benefit you or the person for whose benefit you are applying;
- (xviii) understand that our Company and the Sole Global Coordinator will rely on your declarations and representations in deciding whether or not to make any allotment of any of the Hong Kong Offer Shares to you and that you may be prosecuted for making a false declaration;

HOW TO APPLY FOR HONG KONG OFFER SHARES

- (xix) (if the application is made for your own benefit) warrant that no other application has been or will be made for your benefit on a **WHITE** or **YELLOW** Application Form or by giving **electronic application instructions** to HKSCC or to the **HK eIPO White Form** Service Provider by you or by any one as your agent or by any other person, except in respect of Employee Reserved Shares applied under the Employee Preferential Offering, if applicable; and
- (xx) (if you are making the application as an agent for the benefit of another person) warrant that (i) no other application has been or will be made by you as agent for or for the benefit of that person or by that person or by any other person as agent for that person on a **WHITE** or **YELLOW** Application Form or by giving **electronic application instructions** to HKSCC; and (ii) you have due authority to sign the Application Form or give **electronic application instructions** on behalf of that other person as their agent, except in respect of Employee Reserved Shares applied under the Employee Preferential Offering, if applicable.

Additional Instructions for YELLOW Application Form

You may refer to the **YELLOW** Application Form for details.

5. APPLYING THROUGH HK eIPO WHITE FORM SERVICE**General**

Individuals who meet the criteria in “Who can apply” in this section, may apply through the **HK eIPO White Form** service for the Offer Shares to be allotted and registered in their own names through the designated website at www.hkeipo.hk.

Detailed instructions for application through the **HK eIPO White Form** service are on the designated website. If you do not follow the instructions, your application may be rejected and may not be submitted to our Company. If you apply through the designated website, you authorize the **HK eIPO White Form** Service Provider to apply on the terms and conditions in this prospectus, as supplemented and amended by the terms and conditions of the **HK eIPO White Form** service.

Time for Submitting Applications under the HK eIPO White Form

You may submit your application to the **HK eIPO White Form** Service Provider at www.hkeipo.hk (24 hours daily, except on the last application day) from 9.00 a.m. on Monday, April 30, 2018 until 11:30 a.m. on Friday, May 4, 2018 and the latest time for completing full payment of application monies in respect of such applications will be 12:00 noon on Friday, May 4, 2018 or such later time under “10. Effect of Bad Weather on the Opening of the Application Lists” in this section.

HOW TO APPLY FOR HONG KONG OFFER SHARES

No Multiple Applications

If you apply by means of **HK eIPO White Form**, once you complete payment in respect of any **electronic application instruction** given by you or for your benefit through the **HK eIPO White Form** service to make an application for Hong Kong Offer Shares, an actual application shall be deemed to have been made. For the avoidance of doubt, giving an **electronic application instruction** under **HK eIPO White Form** more than once and obtaining different payment reference numbers without effecting full payment in respect of a particular reference number will not constitute an actual application.

If you are suspected of submitting more than one application through the **HK eIPO White Form** service or by any other means, all of your applications are liable to be rejected.

Section 40 of the Companies (Winding Up and Miscellaneous Provisions) Ordinance

For the avoidance of doubt, our Company and all other parties involved in the preparation of this prospectus acknowledge that each applicant who gives or causes to give **electronic application instructions** is a person who may be entitled to compensation under Section 40 of the Companies (Winding Up and Miscellaneous Provisions) Ordinance (as applied by Section 342E of the Companies (Winding Up and Miscellaneous Provisions) Ordinance).

6. APPLYING BY GIVING ELECTRONIC APPLICATION INSTRUCTIONS TO HKSCC VIA CCASS**General**

CCASS Participants may give **electronic application instructions** to apply for the Hong Kong Offer Shares and to arrange payment of the money due on application and payment of refunds under their participant agreements with HKSCC and the General Rules of CCASS and the CCASS Operational Procedures.

If you are a CCASS Investor Participant, you may give these **electronic application instructions** through the CCASS Phone System by calling 2979 7888 or through the CCASS Internet System (<https://ip.ccass.com>) (using the procedures in HKSCC's "An Operating Guide for Investor Participants" in effect from time to time).

HKSCC can also input **electronic application instructions** for you if you go to:

Hong Kong Securities Clearing Company Limited

Customer Service Centre
1/F, One & Two Exchange Square, 8 Connaught Place, Central,
Hong Kong

and complete an input request form.

HOW TO APPLY FOR HONG KONG OFFER SHARES

You can also collect a prospectus from this address.

If you are not a CCASS Investor Participant, you may instruct your broker or custodian who is a CCASS Clearing Participant or a CCASS Custodian Participant to give **electronic application instructions** via CCASS terminals to apply for the Hong Kong Offer Shares on your behalf.

You will be deemed to have authorized HKSCC and/or HKSCC Nominees to transfer the details of your application to our Company, the Sole Global Coordinator and our Hong Kong Share Registrar.

Giving Electronic Application Instructions to HKSCC via CCASS

Where you have given **electronic application instructions** to apply for the Hong Kong Offer Shares and a **WHITE** Application Form is signed by HKSCC Nominees on your behalf:

- (i) HKSCC Nominees will only be acting as a nominee for you and is not liable for any breach of the terms and conditions of the **WHITE** Application Form or this prospectus;
- (ii) HKSCC Nominees will do the following things on your behalf:
 - agree that the Hong Kong Offer Shares to be allotted shall be issued in the name of HKSCC Nominees and deposited directly into CCASS for the credit of the CCASS Participant's stock account on your behalf or your CCASS Investor Participant's stock account;
 - agree to accept the Hong Kong Offer Shares applied for or any lesser number allocated;
 - undertake and confirm that you have not applied for or taken up, will not apply for or take up, or indicate an interest for, any Offer Shares under the International Offering;
 - (if the **electronic application instructions** are given for your benefit) declare that only one set of **electronic application instructions** has been given for your benefit;
 - (if you are an agent for another person) declare that you have only given one set of **electronic application instructions** for the other person's benefit and are duly authorized to give those instructions as their agent;
 - confirm that you understand that our Company, the Selling Shareholder, our Directors and the Sole Global Coordinator will rely on your declarations and representations in deciding whether or not to make any allotment of any of the Hong Kong Offer Shares to you and that you may be prosecuted if you make a false declaration;

HOW TO APPLY FOR HONG KONG OFFER SHARES

- authorize our Company to place HKSCC Nominees' name on our Company's register of members as the holder of the Hong Kong Offer Shares allocated to you and to send share certificate(s) and/or refund monies under the arrangements separately agreed between us and HKSCC;
- confirm that you have read the terms and conditions and application procedures set out in this prospectus and agree to be bound by them;
- confirm that you have received and/or read a copy of this prospectus and have relied only on the information and representations in this prospectus in causing the application to be made, save as set out in any supplement to this prospectus;
- agree that none of our Company, the Selling Shareholder, the Sole Global Coordinator, the Underwriters, their respective directors, officers, employees, partners, agents, advisers and any other parties involved in the Global Offering, is or will be liable for any information and representations not contained in this prospectus (and any supplement to it);
- agree to disclose your personal data to our Company, the Selling Shareholder, our Hong Kong Share Registrar, receiving banks, the Sole Global Coordinator, the Underwriters and/or its respective advisers and agents;
- agree (without prejudice to any other rights which you may have) that once HKSCC Nominees' application has been accepted, it cannot be rescinded for innocent misrepresentation;
- agree that any application made by HKSCC Nominees on your behalf is irrevocable before the fifth day after the time of the opening of the application lists (excluding any day which is Saturday, Sunday or public holiday in Hong Kong), such agreement to take effect as a collateral contract with us and to become binding when you give the instructions and such collateral contract to be in consideration of our Company agreeing that it will not offer any Hong Kong Offer Shares to any person before the fifth day after the time of the opening of the application lists (excluding any day which is Saturday, Sunday or public holiday in Hong Kong), except by means of one of the procedures referred to in this prospectus. However, HKSCC Nominees may revoke the application before the fifth day after the time of the opening of the application lists (excluding for this purpose any day which is a Saturday, Sunday or public holiday in Hong Kong) if a person responsible for this prospectus under Section 40 of the Companies (Winding Up and Miscellaneous Provisions) Ordinance gives a public notice under that section which excludes or limits that person's responsibility for this prospectus;

HOW TO APPLY FOR HONG KONG OFFER SHARES

- agree that once HKSCC Nominees' application is accepted, neither that application nor your **electronic application instructions** can be revoked, and that acceptance of that application will be evidenced by our Company's announcement of the Hong Kong Public Offering results;
- agree to the arrangements, undertakings and warranties under the participant agreement between you and HKSCC, read with the General Rules of CCASS and the CCASS Operational Procedures, for the giving **electronic application instructions** to apply for Hong Kong Offer Shares;
- agree with our Company, for itself and for the benefit of each Shareholder (and so that our Company will be deemed by its acceptance in whole or in part of the application by HKSCC Nominees to have agreed, for itself and on behalf of each of the Shareholders, with each CCASS Participant giving **electronic application instructions**) to observe and comply with the Companies (Winding Up and Miscellaneous Provisions) Ordinance, the Companies Ordinance and the Bye-Laws; and
- agree that your application, any acceptance of it and the resulting contract will be governed by the laws of Hong Kong.

Effect of Giving Electronic Application Instructions to HKSCC via CCASS

By giving **electronic application instructions** to HKSCC or instructing your broker or custodian who is a CCASS Clearing Participant or a CCASS Custodian Participant to give such instructions to HKSCC, you (and, if you are joint applicants, each of you jointly and severally) are deemed to have done the following things. Neither HKSCC nor HKSCC Nominees shall be liable to our Company or any other person in respect of the things mentioned below:

- instructed and authorized HKSCC to cause HKSCC Nominees (acting as nominee for the relevant CCASS Participants) to apply for the Hong Kong Offer Shares on your behalf;
- instructed and authorized HKSCC to arrange payment of the maximum Offer Price, brokerage, SFC transaction levy and the Hong Kong Stock Exchange trading fee by debiting your designated bank account and, in the case of a wholly or partially unsuccessful application and/or if the Offer Price is less than the maximum Offer Price per Offer Share initially paid on application, refund of the application monies (including brokerage, SFC transaction levy and the Hong Kong Stock Exchange trading fee) by crediting your designated bank account; and
- instructed and authorized HKSCC to cause HKSCC Nominees to do on your behalf all the things stated in the **WHITE** Application Form and in this prospectus.

HOW TO APPLY FOR HONG KONG OFFER SHARES

Minimum Purchase Amount and Permitted Numbers

You may give or cause your broker or custodian who is a CCASS Clearing Participant or a CCASS Custodian Participant to give **electronic application instructions** for a minimum of 2,000 Hong Kong Offer Shares. Instructions for more than 2,000 Hong Kong Offer Shares must be in one of the numbers set out in the table in the Application Forms. No application for any other number of Hong Kong Offer Shares will be considered and any such application is liable to be rejected.

Time for Inputting Electronic Application Instructions

CCASS Clearing/Custodian Participants can input **electronic application instructions** at the following times on the following dates:

Monday, April 30, 2018	—	9:00 a.m. to 8:30 p.m.⁽¹⁾
Wednesday, May 2, 2018	—	8:00 a.m. to 8:30 p.m.⁽¹⁾
Thursday, May 3, 2018	—	8:00 a.m. to 8:30 p.m.⁽¹⁾
Friday, May 4, 2018	—	8:00 a.m.⁽¹⁾ to 12:00 noon

Note:

(1) These times are subject to change as HKSCC may determine from time to time with prior notification to CCASS Clearing/Custodian Participants.

CCASS Investor Participants can input **electronic application instructions** from 9:00 a.m. on Monday, April 30, 2018 until 12:00 noon on Friday, May 4, 2018 (24 hours daily, except on the last application day).

The latest time for inputting your **electronic application instructions** will be 12:00 noon on Friday, May 4, 2018, the last application day or such later time as described in “10. Effect of Bad Weather on the Opening of the Application Lists” in this section.

No Multiple Applications

If you are suspected of having made multiple applications or if more than one application is made for your benefit, the number of Hong Kong Offer Shares applied for by HKSCC Nominees will be automatically reduced by the number of Hong Kong Offer Shares for which you have given such instructions and/or for which such instructions have been given for your benefit. Any **electronic application instructions** to make an application for the Hong Kong Offer Shares given by you or for your benefit to HKSCC shall be deemed to be an actual application for the purposes of considering whether multiple applications have been made.

Section 40 of the Companies (Winding Up and Miscellaneous Provisions) Ordinance

For the avoidance of doubt, our Company and all other parties involved in the preparation of this prospectus acknowledge that each CCASS Participant who gives or causes to give **electronic application instructions** is a person who may be entitled to

HOW TO APPLY FOR HONG KONG OFFER SHARES

compensation under Section 40 of the Companies (Winding Up and Miscellaneous Provisions) Ordinance (as applied by Section 342E of the Companies (Winding Up and Miscellaneous Provisions) Ordinance).

Personal Data

The section of the Application Form headed “Personal Data” applies to any personal data held by our Company, the Selling Shareholder, the Hong Kong Share Registrar, the receiving bankers, the Sole Global Coordinator, the Underwriters and any of their respective advisers and agents about you in the same way as it applies to personal data about applicants other than HKSCC Nominees.

7. WARNING FOR ELECTRONIC APPLICATIONS

The subscription of the Hong Kong Offer Shares by giving **electronic application instructions** to HKSCC is only a facility provided to CCASS Participants. Similarly, the application for Hong Kong Offer Shares through the **HK eIPO White Form** service is also only a facility provided by the **HK eIPO White Form** Service Provider to public investors. Such facilities are subject to capacity limitations and potential service interruptions and you are advised not to wait until the last application day in making your electronic applications. Our Company, the Selling Shareholder, our Directors, the Joint Lead Managers, the Joint Bookrunners, the Sole Global Coordinator, the Joint Sponsors and the Underwriters take no responsibility for such applications and provide no assurance that any CCASS Participant or person applying through the **HK eIPO White Form** service will be allotted any Hong Kong Offer Shares.

To ensure that CCASS Investor Participants can give their **electronic application instructions**, they are advised not to wait until the last minute to input their instructions to the systems. In the event that CCASS Investor Participants have problems in the connection to CCASS Phone System/CCASS Internet System for submission of **electronic application instructions**, they should either (i) submit a **WHITE** or **YELLOW** Application Form, or (ii) go to HKSCC’s Customer Service Centre to complete an input request form for **electronic application instructions** before 12:00 noon on Friday, May 4, 2018.

8. HOW MANY APPLICATIONS CAN YOU MAKE

Multiple applications for the Hong Kong Offer Shares are not allowed except by nominees. If you are a nominee, in the box on the Application Form marked “For nominees” you must include:

- an account number; or
- some other identification code,

for each beneficial owner or, in the case of joint beneficial owners, for each joint beneficial owner. If you do not include this information, the application will be treated as being made for your benefit.

HOW TO APPLY FOR HONG KONG OFFER SHARES

In addition, if you are an Eligible Employee you may also make an application for Employee Reserved Shares by using a **PINK** Application Form. Only one application for Employee Reserved Shares is permitted per Eligible Employee under the Employee Preferential Offering. Multiple applications by any Eligible Employee via **PINK** Application Form are liable to be rejected.

All of your applications will be rejected if more than one application on a **WHITE** or **YELLOW** Application Form or by giving **electronic application instructions** to HKSCC or through **HK eIPO White Form** service, is made for your benefit (including the part of the application made by HKSCC Nominees acting on **electronic application instructions**). If an application is made by an unlisted company and:

- the principal business of that company is dealing in securities; and
- you exercise statutory control over that company,

then the application will be treated as being for your benefit.

“Unlisted company” means a company with no equity securities listed on the Hong Kong Stock Exchange.

“Statutory control” means you:

- control the composition of the board of directors of the company;
- control more than half of the voting power of the company; or
- hold more than half of the issued share capital of the company (not counting any part of it which carries no right to participate beyond a specified amount in a distribution of either profits or capital).

9. HOW MUCH ARE THE HONG KONG OFFER SHARES

The **WHITE** and **YELLOW** Application Forms have tables showing the exact amount payable for Shares. The **PINK** Application Form has a table showing the exact amount payable for multiples of Shares applied for up to 2,392,000 Employee Reserved Shares.

You must pay the maximum Offer Price, brokerage, SFC transaction levy and the Hong Kong Stock Exchange trading fee in full upon application for Shares under the terms set out in the Application Forms.

You may submit an application using a **WHITE** and/or **PINK** or **YELLOW** Application Form or through the **HK eIPO White Form** service in respect of a minimum of 2,000 Hong Kong Offer Shares. Each application or **electronic application instruction** in respect of more than 2,000 Hong Kong Offer Shares must be in one of the numbers set out in the table in the Application Form, or as otherwise specified on the designated website at www.hkeipo.hk.

HOW TO APPLY FOR HONG KONG OFFER SHARES

If your application is successful, brokerage will be paid to the Exchange Participants, and the SFC transaction levy and the Hong Kong Stock Exchange trading fee are paid to the Hong Kong Stock Exchange (in the case of the SFC transaction levy, collected by the Hong Kong Stock Exchange on behalf of the SFC).

For further details on the Offer Price, please refer to the section headed “Structure of the Global Offering — Determining the Offer Price” in this prospectus.

10. EFFECT OF BAD WEATHER ON THE OPENING OF THE APPLICATION LISTS

The application lists will not open if there is:

- a tropical cyclone warning signal number 8 or above; or
- a “black” rainstorm warning,

in force in Hong Kong at any time between 9:00 a.m. and 12:00 noon on Friday, May 4, 2018. Instead they will open between 11:45 a.m. and 12:00 noon on the next business day which does not have either of those warnings in Hong Kong in force at any time between 9:00 a.m. and 12:00 noon.

If the application lists do not open and close on Friday, May 4, 2018 or if there is a tropical cyclone warning signal number 8 or above or a “black” rainstorm warning signal in force in Hong Kong that may affect the dates mentioned in the section headed “Expected Timetable” in this prospectus, an announcement will be made in such event.

11. PUBLICATION OF RESULTS

Our Company expects to announce the final Offer Price, the level of indication of interest in the International Offering, the level of applications in the Hong Kong Public Offering (including the Employee Preferential Offering) and the basis of allocation of the Hong Kong Offer Shares on Thursday, May 10, 2018 on our Company’s website at www.twcoffee.com and the website of the Hong Kong Stock Exchange at www.hkexnews.hk.

The results of allocations and the Hong Kong identity card/passport/Hong Kong business registration numbers of successful applicants under the Hong Kong Public Offering (including the Employee Preferential Offering) will be available at the times and date and in the manner specified below:

- in the announcement to be posted on our Company’s website at www.twcoffee.com and the Hong Kong Stock Exchange’s website at www.hkexnews.hk by no later than 9:00 a.m., on Thursday, May 10, 2018;
- from the designated results of allocations website at www.tricor.com.hk/ipo/result with a “search by ID” function on a 24-hour basis from 8:00 a.m. on Thursday, May 10, 2018 to 12:00 midnight on Wednesday, May 16, 2018;

HOW TO APPLY FOR HONG KONG OFFER SHARES

- by telephone enquiry line by calling (852) 3691 8488 between 9:00 a.m. and 6:00 p.m. from Thursday, May 10, 2018 to Tuesday, May 15, 2018 (excluding Saturday, Sunday and public holiday);
- in the special allocation results booklets which will be available for inspection during opening hours from Thursday, May 10, 2018 to Monday, May 14, 2018 at all the receiving bank designated branches.

If our Company accepts your offer to purchase (in whole or in part), which it may do by announcing the basis of allocations and/or making available the results of allocations publicly, there will be a binding contract under which you will be required to purchase the Hong Kong Offer Shares if the conditions of the Global Offering are satisfied and the Global Offering is not otherwise terminated. For further details, please refer to the section headed “Structure of the Global Offering” in this prospectus.

You will not be entitled to exercise any remedy of rescission for innocent misrepresentation at any time after acceptance of your application. This does not affect any other right you may have.

12. CIRCUMSTANCES IN WHICH YOU WILL NOT BE ALLOTTED OFFER SHARES

You should note the following situations in which the Hong Kong Offer shares will not be allotted to you:

(i) If your application is revoked:

By completing and submitting an Application Form or giving **electronic application instructions** to HKSCC or to **HK eIPO White Form** Service Provider, you agree that your application or the application made by HKSCC Nominees on your behalf cannot be revoked on or before the fifth day after the time of the opening of the application lists (excluding for this purpose any day which is Saturday, Sunday or public holiday in Hong Kong). This agreement will take effect as a collateral contract with our Company.

Your application or the application made by HKSCC Nominees on your behalf may only be revoked on or before such fifth day if a person responsible for this prospectus under Section 40 of the Companies (Winding Up and Miscellaneous Provisions) Ordinance (as applied by Section 342E of the Companies (Winding Up and Miscellaneous Provisions) Ordinance) gives a public notice under that section which excludes or limits that person’s responsibility for this prospectus.

If any supplement to this prospectus is issued, applicants who have already submitted an application will be notified that they are required to confirm their applications. If applicants have been so notified but have not confirmed their applications in accordance with the procedure to be notified, all unconfirmed applications will be deemed revoked.

HOW TO APPLY FOR HONG KONG OFFER SHARES

If your application or the application made by HKSCC Nominees on your behalf has been accepted, it cannot be revoked. For this purpose, acceptance of applications which are not rejected will be constituted by notification in the press of the results of allocation, and where such basis of allocation is subject to certain conditions or provides for allocation by ballot, such acceptance will be subject to the satisfaction of such conditions or results of the ballot respectively.

(ii) If our Company or its agents exercise their discretion to reject your application:

Our Company, the Sole Global Coordinator, the **HK eIPO White Form** Service Provider and their respective agents and nominees have full discretion to reject or accept any application, or to accept only part of any application, without giving any reasons.

(iii) If the allotment of Hong Kong Offer Shares is void:

The allotment of Hong Kong Offer Shares will be void if the Listing Committee of the Hong Kong Stock Exchange does not grant permission to list the Shares either:

- within three weeks from the closing date of the application lists; or
- within a longer period of up to six weeks if the Listing Committee notifies our Company of that longer period within three weeks of the closing date of the application lists.

(iv) If:

- you make multiple applications or suspected multiple applications;
- you or the person for whose benefit you are applying have applied for or taken up, or indicated an interest for, or have been or will be placed or allocated (including conditionally and/or provisionally) Hong Kong Offer Shares and International Offer Shares;
- your Application Form is not completed in accordance with the stated instructions;
- your **electronic application instructions** through the **HK eIPO White Form** service are not completed in accordance with the instructions, terms and conditions on the designated website;
- your payment is not made correctly or the cheque or banker's cashier order paid by you is dishonoured upon its first presentation;
- the Underwriting Agreements do not become unconditional or are terminated;

HOW TO APPLY FOR HONG KONG OFFER SHARES

- our Company or the Sole Global Coordinator believe that by accepting your application, it or they would violate applicable securities or other laws, rules or regulations;
- your application is for more than 50% of the Hong Kong Offer Shares initially offered under the Hong Kong Public Offering (after deduction of the Employee Reversed Shares initially available); or
- you are an Eligible Employee, your application is for more than 2,392,000 Employee Reserved Shares.

13. REFUND OF APPLICATION MONIES

If an application is rejected, not accepted or accepted in part only, or if the Offer Price as finally determined is less than the maximum Offer Price of HK\$2.19 per Offer Share (excluding brokerage, SFC transaction levy and the Hong Kong Stock Exchange trading fee thereon), or if the conditions of the Hong Kong Public Offering are not fulfilled in accordance with “Structure of the Global Offering — Conditions of the Hong Kong Public Offering” in this prospectus or if any application is revoked, the application monies, or the appropriate portion thereof, together with the related brokerage, SFC transaction levy and the Hong Kong Stock Exchange trading fee, will be refunded, without interest or the cheque or banker’s cashier order will not be cleared.

Any refund of your application monies will be made on Thursday, May 10, 2018.

14. DESPATCH/COLLECTION OF SHARE CERTIFICATES AND REFUND MONIES

You will receive one share certificate for all Hong Kong Offer Shares allotted to you under the Hong Kong Public Offering (except pursuant to applications made on **YELLOW** Application Forms or by **electronic application instructions** to HKSCC via CCASS where the Share certificates will be deposited into CCASS as described below) and one Share certificate for all Employee Reserved Shares allotted to you under the Employee Preferential Offering.

No temporary document of title will be issued in respect of the Shares. No receipt will be issued for sums paid on application. If you apply by **WHITE** and/or **PINK** or **YELLOW** Application Form, subject to personal collection as mentioned below, the following will be sent to you (or, in the case of joint applicants, to the first-named applicant) by ordinary post, at your own risk, to the address specified on the Application Form:

- Share certificate(s) for all the Hong Kong Offer Shares allotted to you (for **YELLOW** Application Forms, Share certificates will be deposited into CCASS as described below); and
- refund cheque(s) crossed “Account Payee Only” in favour of the applicant (or, in the case of joint applicants, the first-named applicant) for (i) all or the surplus application monies for the Hong Kong Offer Shares, wholly or partially

HOW TO APPLY FOR HONG KONG OFFER SHARES

unsuccessfully applied for; and/or (ii) the difference between the Offer Price and the maximum Offer Price per Offer Share paid on application in the event that the Offer Price is less than the maximum Offer Price (including brokerage, SFC transaction levy and the Hong Kong Stock Exchange trading fee but without interest). Part of the Hong Kong identity card number/passport number, provided by you or the first-named applicant (if you are joint applicants), may be printed on your refund cheque(s), if any. Your banker may require verification of your Hong Kong identity card number/passport number before encashment of your refund cheque(s). Inaccurate completion of your Hong Kong identity card number/passport number may invalidate or delay encashment of your refund cheque(s).

Subject to arrangement on dispatch/collection of Share certificates and refund monies as mentioned below, any refund checks and Share certificates are expected to be posted on or around Thursday, May 10, 2018. The right is reserved to retain any share certificate(s) and any surplus application monies pending clearance of cheque(s) or banker's cashier's order(s).

Share certificates will only become valid at 8:00 a.m. on Friday, May 11, 2018 provided that the Global Offering has become unconditional and the right of termination described in the section headed "Underwriting" in this prospectus has not been exercised. Investors who trade shares prior to the receipt of Share certificates or the Share certificates becoming valid do so at their own risk.

Personal Collection***(i) If you apply using a WHITE and/or PINK Application Form***

If you are an Eligible Employee and you apply for 1,000,000 Employee Reserved Shares or more under the Employee Preferential Offering or you apply for 1,000,000 or more Hong Kong Offer Shares and have provided all information required by your Application Form, you may collect your refund cheque(s) and/or Share certificate(s) from the Hong Kong Share Registrar, Tricor Investor Services Limited, at Level 22, Hopewell Centre, 183 Queen's Road East, Hong Kong, from 9:00 a.m. to 1:00 p.m. on Thursday, May 10, 2018 or such other date as notified by us in the newspapers.

If you are an individual who is eligible for personal collection, you must not authorize any other person to collect for you. If you are a corporate applicant which is eligible for personal collection, your authorized representative must bear a letter of authorization from your corporation stamped with your corporation's chop. Both individuals and authorized representatives must produce, at the time of collection, evidence of identity acceptable to the Hong Kong Share Registrar.

If you do not collect your refund cheque(s) and/or Share certificate(s) personally within the time specified for collection, they will be despatched promptly to the address specified in your Application Form by ordinary post at your own risk.

HOW TO APPLY FOR HONG KONG OFFER SHARES

If you are an Eligible Employee and you apply for less than 1,000,000 Employee Reserved Shares under Employee Preferential Offering or you apply for less than 1,000,000 Hong Kong Offer Shares, your refund cheque(s) and/or Share certificate(s) will be sent to the address on the relevant Application Form on Thursday, May 10, 2018, by ordinary post and at your own risk.

(ii) If you apply using a YELLOW Application Form

If you apply for 1,000,000 Hong Kong Offer Shares or more, please follow the same instructions as described above. If you have applied for less than 1,000,000 Hong Kong Offer Shares, your refund cheque(s) will be sent to the address on the relevant Application Form on Thursday, May 10, 2018, by ordinary post and at your own risk.

If you apply by using a **YELLOW** Application Form and your application is wholly or partially successful, your Share certificate(s) will be issued in the name of HKSCC Nominees and deposited into CCASS for credit to your or the designated CCASS Participant's stock account as stated in your Application Form on Thursday, May 10, 2018, or upon contingency, on any other date determined by HKSCC or HKSCC Nominees.

- *If you apply through a designated CCASS participant (other than a CCASS investor participant)*

For Hong Kong Offer Shares credited to your designated CCASS participant's stock account (other than CCASS Investor Participant), you can check the number of Hong Kong Offer Shares allotted to you with that CCASS participant.

- *If you are applying as a CCASS Investor Participant*

Our Company will publish the results of CCASS Investor Participants' applications together with the results of the Hong Kong Public Offering (including the Employee Preferential Offering) in the manner described in "Publication of Results" above. You should check the announcement published by our Company and report any discrepancies to HKSCC before 5:00 p.m., on Thursday, May 10, 2018 or any other date as determined by HKSCC or HKSCC Nominees. Immediately after the credit of the Hong Kong Offer Shares to your stock account, you can check your new account balance via the CCASS Phone System and CCASS Internet System.

HOW TO APPLY FOR HONG KONG OFFER SHARES

(iii) If you apply through the HK eIPO White Form Service

If you apply for 1,000,000 Hong Kong Offer Shares or more and your application is wholly or partially successful, you may collect your Share certificate(s) from the Hong Kong Share Registrar, Tricor Investor Services Limited, at Level 22, Hopewell Centre, 183 Queen's Road East, Hong Kong, from 9:00 a.m. to 1:00 p.m. on Thursday, May 10, 2018, or such other date as notified by our Company in the newspapers as the date of despatch/collection of Share certificates/e-Auto Refund payment instructions/refund checks.

If you do not collect your Share certificate(s) personally within the time specified for collection, they will be sent to the address specified in your application instructions by ordinary post at your own risk.

If you apply for less than 1,000,000 Hong Kong Offer Shares, your Share certificate(s) (where applicable) will be sent to the address specified in your application instructions on Thursday, May 10, 2018 by ordinary post at your own risk.

If you apply and pay the application monies from a single bank account, any refund monies will be despatched to that bank account in the form of e-Auto Refund payment instructions. If you apply and pay the application monies from multiple bank accounts, any refund monies will be despatched to the address as specified in your application instructions in the form of refund cheque(s) by ordinary post at your own risk.

*(iv) If you apply via electronic application instructions to HKSCC**Allocation of Hong Kong Offer Shares*

For the purposes of allocating Hong Kong Offer Shares, HKSCC Nominees will not be treated as an applicant. Instead, each CCASS Participant who gives **electronic application instructions** or each person for whose benefit instructions are given will be treated as an applicant.

Deposit of share certificates into CCASS and refund of application monies

- If your application is wholly or partially successful, your share certificate(s) will be issued in the name of HKSCC Nominees and deposited into CCASS for the credit of your designated CCASS Participant's stock account or your CCASS Investor Participant stock account on Thursday, May 10, 2018, or, on any other date determined by HKSCC or HKSCC Nominees.

HOW TO APPLY FOR HONG KONG OFFER SHARES

- Our Company expects to publish the application results of CCASS Participants (and where the CCASS Participant is a broker or custodian, our Company will include information relating to the relevant beneficial owner), your Hong Kong identity card number/passport number or other identification code (Hong Kong business registration number for corporations) and the basis of allotment of the Hong Kong Public Offering (including the Employee Preferential Offering) in the manner specified in “Publication of Results” above on Thursday, May 10, 2018. You should check the announcement published by our Company and report any discrepancies to HKSCC before 5:00 p.m. on Thursday, May 10, 2018 or such other date as determined by HKSCC or HKSCC Nominees.
- If you have instructed your broker or custodian to give **electronic application instructions** on your behalf, you can also check the number of Hong Kong Offer Shares allotted to you and the amount of refund monies (if any) payable to you with that broker or custodian.
- If you have applied as a CCASS Investor Participant, you can also check the number of Hong Kong Offer Shares allotted to you and the amount of refund monies (if any) payable to you via the CCASS Phone System and the CCASS Internet System (under the procedures contained in HKSCC’s “An Operating Guide for Investor Participants” in effect from time to time) on Thursday, May 10, 2018. Immediately following the credit of the Hong Kong Offer Shares to your stock account and the credit of refund monies to your bank account, HKSCC will also make available to you an activity statement showing the number of Hong Kong Offer Shares credited to your CCASS Investor Participant stock account and the amount of refund monies (if any) credited to your designated bank account.
- Refund of your application monies (if any) in respect of wholly and partially unsuccessful applications and/or difference between the Offer Price and the maximum Offer Price per Offer Share initially paid on application (including brokerage, SFC transaction levy and the Hong Kong Stock Exchange trading fee but without interest) will be credited to your designated bank account or the designated bank account of your broker or custodian on Thursday, May 10, 2018.

HOW TO APPLY FOR HONG KONG OFFER SHARES

15. ADMISSION OF THE SHARES INTO CCASS

If the Hong Kong Stock Exchange grants the listing of, and permission to deal in, our Shares and we comply with the stock admission requirements of HKSCC, our Shares will be accepted as eligible securities by HKSCC for deposit, clearance and settlement in CCASS with effect from the date of commencement of dealings in our Shares or any other date HKSCC chooses. Settlement of transactions between Exchange Participants (as defined in the Listing Rules) is required to take place in CCASS on the second business day after any trading day.

All activities under CCASS are subject to the General Rules of CCASS and CCASS Operational Procedures in effect from time to time.

Investors should seek the advice of their stockbroker or other professional adviser for details of the settlement arrangement as such arrangements may affect their rights and interests.

All necessary arrangements have been made enabling our Shares to be admitted into CCASS.

The following is the text of a report, prepared for the purpose of incorporation in this prospectus, received from the Company's Reporting Accountants, Ernst & Young, Certified Public Accountants, Hong Kong.



22/F CITIC Tower
1 Tim Mei Avenue
Central, Hong Kong

The Directors
Tsit Wing International Holdings Limited

BOCI Asia Limited
BOSC International Company Limited

Dear Sirs,

We report on the historical financial information of Tsit Wing International Holdings Limited (the “Company”) and its subsidiaries (together, the “Group”) set out on pages I-4 to I-79, which comprises the consolidated statements of profit or loss, consolidated statements of comprehensive income, consolidated statements of changes in equity and consolidated statements of cash flows of the Group for each of the years ended December 31, 2015, 2016 and 2017 (the “Track Record Period”), and the consolidated statements of financial position of the Group and the statements of financial position of the Company as at December 31, 2015, 2016 and 2017, and a summary of significant accounting policies and other explanatory information (together, the “Historical Financial Information”). The Historical Financial Information set out on pages I-4 to I-79 forms an integral part of this report, which has been prepared for inclusion in the prospectus of the Company dated April 30, 2018 (the “Prospectus”) in connection with the initial listing of the shares of the Company on the Main Board of The Stock Exchange of Hong Kong Limited (the “Stock Exchange”).

DIRECTORS' RESPONSIBILITY FOR THE HISTORICAL FINANCIAL INFORMATION

The directors of the Company are responsible for the preparation of the Historical Financial Information that gives a true and fair view in accordance with the basis of preparation set out in note 2.1 to the Historical Financial Information, and for such internal control as the directors determine is necessary to enable the preparation of the Historical Financial Information that is free from material misstatement, whether due to fraud or error.

REPORTING ACCOUNTANTS' RESPONSIBILITY

Our responsibility is to express an opinion on the Historical Financial Information and to report our opinion to you. We conducted our work in accordance with Hong Kong Standard on Investment Circular Reporting Engagements 200 *Accountants' Reports on Historical Financial Information in Investment Circulars* issued by the Hong Kong Institute of Certified Public Accountants ("HKICPA"). This standard requires that we comply with ethical standards and plan and perform our work to obtain reasonable assurance about whether the Historical Financial Information is free from material misstatement.

Our work involved performing procedures to obtain evidence about the amounts and disclosures in the Historical Financial Information. The procedures selected depend on the reporting accountants' judgement, including the assessment of risks of material misstatement of the Historical Financial Information, whether due to fraud or error. In making those risk assessments, the reporting accountants consider internal control relevant to the entity's preparation of the Historical Financial Information that gives a true and fair view in accordance with the basis of preparation set out in note 2.1 to the Historical Financial Information, in order to design procedures that are appropriate in the circumstances, but not for the purpose of expressing an opinion on the effectiveness of the entity's internal control. Our work also included evaluating the appropriateness of accounting policies used and the reasonableness of accounting estimates made by the directors, as well as evaluating the overall presentation of the Historical Financial Information.

We believe that the evidence we have obtained is sufficient and appropriate to provide a basis for our opinion.

OPINION

In our opinion, the Historical Financial Information gives, for the purposes of the accountants' report, a true and fair view of the financial position of the Group and the Company as at December 31, 2015, 2016 and 2017 and of the financial performance and cash flows of the Group for each of the Track Record Period in accordance with the basis of preparation set out in note 2.1 to the Historical Financial Information.

REPORT ON MATTERS UNDER THE RULES GOVERNING THE LISTING OF SECURITIES ON THE MAIN BOARD OF THE STOCK EXCHANGE AND THE COMPANIES (WINDING UP AND MISCELLANEOUS PROVISIONS) ORDINANCE**Adjustments**

The Historical Financial Information is stated after making such adjustments to the Historical Financial Statements as defined on page I-4 as were considered necessary.

Dividends

We refer to note 12 to the Historical Financial Information which contains information about the dividends paid by the Company in respect of the Track Record Period.

Yours faithfully,

Ernst & Young
Certified Public Accountants
Hong Kong

April 30, 2018

I. HISTORICAL FINANCIAL INFORMATION**Preparation of Historical Financial Information**

Set out below is the Historical Financial Information which forms an integral part of this accountants' report.

The Historical Financial Information in this report was prepared based on previously issued financial statements of the Group for each of the Track Record Period. The previously issued financial statements were audited by Ernst & Young, Hong Kong in accordance with Hong Kong Standards on Auditing issued by the HKICPA (the "Historical Financial Statements").

The Historical Financial Information is presented in Hong Kong dollars ("HK\$") and all values are rounded to the nearest thousand (HK\$'000) except when otherwise indicated.

APPENDIX I

ACCOUNTANTS' REPORT

CONSOLIDATED STATEMENTS OF PROFIT OR LOSS

	<i>Notes</i>	Year ended December 31,		
		2015 <i>HK\$'000</i>	2016 <i>HK\$'000</i>	2017 <i>HK\$'000</i>
CONTINUING OPERATIONS				
REVENUE	5	838,152	849,720	954,610
Cost of sales		<u>(591,748)</u>	<u>(575,626)</u>	<u>(664,996)</u>
Gross profit		246,404	274,094	289,614
Other income and gains, net	5	17,277	17,061	3,998
Selling and distribution expenses		(97,480)	(108,890)	(112,245)
Administrative expenses		(89,896)	(86,774)	(109,743)
Other expenses, net		(12,000)	(9,844)	(3,325)
Finance costs	6	<u>(4,875)</u>	<u>(4,006)</u>	<u>(4,126)</u>
PROFIT BEFORE TAX FROM CONTINUING OPERATIONS	7	59,430	81,641	64,173
Income tax expense	10	<u>(12,843)</u>	<u>(17,401)</u>	<u>(15,799)</u>
PROFIT FOR THE YEAR FROM CONTINUING OPERATIONS		46,587	64,240	48,374
DISCONTINUED OPERATION (LOSS)/PROFIT FOR THE YEAR FROM A DISCONTINUED OPERATION	11	<u>(7,131)</u>	<u>1,463</u>	<u>—</u>
PROFIT FOR THE YEAR		<u><u>39,456</u></u>	<u><u>65,703</u></u>	<u><u>48,374</u></u>

APPENDIX I

ACCOUNTANTS' REPORT

	<i>Notes</i>	Year ended December 31,		
		2015 <i>HK\$'000</i>	2016 <i>HK\$'000</i>	2017 <i>HK\$'000</i>
Attributable to:				
Owners of the parent				
Profit for the year from continuing operations		48,009	63,243	46,095
(Loss)/profit for the year from a discontinued operation		<u>(6,762)</u>	<u>1,703</u>	<u>—</u>
Profit for the year		<u>41,247</u>	<u>64,946</u>	<u>46,095</u>
Non-controlling interests				
(Loss)/profit for the year from continuing operations		(1,422)	997	2,279
Loss for the year from a discontinued operation		<u>(369)</u>	<u>(240)</u>	<u>—</u>
(Loss)/profit for the year		<u>(1,791)</u>	<u>757</u>	<u>2,279</u>
		<u>39,456</u>	<u>65,703</u>	<u>48,374</u>
		<i>HK cents</i>	<i>HK cents</i>	<i>HK cents</i>
EARNINGS PER SHARE				
ATTRIBUTABLE TO				
ORDINARY EQUITY HOLDERS				
OF THE PARENT				
	13			
Basic and diluted				
— For profit for the year		6.68	10.52	7.46
— For profit for the year from continuing operations		<u>7.77</u>	<u>10.24</u>	<u>7.46</u>

APPENDIX I

ACCOUNTANTS' REPORT

CONSOLIDATED STATEMENTS OF COMPREHENSIVE INCOME

	Year ended December 31,		
	2015	2016	2017
	<i>HK\$'000</i>	<i>HK\$'000</i>	<i>HK\$'000</i>
PROFIT FOR THE YEAR	39,456	65,703	48,374
OTHER COMPREHENSIVE (LOSS)/ INCOME			
Other comprehensive (loss)/income to be reclassified to profit or loss in subsequent periods:			
Exchange differences on translation of foreign operations	<u>(8,854)</u>	<u>(9,907)</u>	<u>11,526</u>
TOTAL COMPREHENSIVE INCOME FOR THE YEAR	<u>30,602</u>	<u>55,796</u>	<u>59,900</u>
Attributable to:			
Owners of the parent	32,489	55,155	57,621
Non-controlling interests	<u>(1,887)</u>	<u>641</u>	<u>2,279</u>
	<u>30,602</u>	<u>55,796</u>	<u>59,900</u>

APPENDIX I

ACCOUNTANTS' REPORT

CONSOLIDATED STATEMENTS OF FINANCIAL POSITION

	<i>Notes</i>	As at December 31,		
		2015	2016	2017
		<i>HK\$'000</i>	<i>HK\$'000</i>	<i>HK\$'000</i>
NON-CURRENT ASSETS				
Property, plant and equipment	14	124,099	111,129	108,021
Prepaid land lease payments	15	12,688	11,429	11,931
Goodwill	16	15,447	15,447	15,447
Intangible assets	17	9,250	7,078	5,020
Investment in an associate	18	—	—	—
Available-for-sale investment	19	7,800	—	—
Deposits paid for purchases of items of property, plant and equipment		1,519	2,702	2,760
Prepayments, deposits and other receivables	23	9,623	3,306	3,616
Deferred tax assets	30	685	360	678
Total non-current assets		<u>181,111</u>	<u>151,451</u>	<u>147,473</u>
CURRENT ASSETS				
Inventories	21	163,651	147,227	195,370
Trade receivables	22	135,164	128,923	170,353
Prepaid land lease payments	15	413	384	415
Prepayments, deposits and other receivables	23	24,257	21,957	19,885
Loans to the ultimate holding company	24	—	42,849	—
Due from the ultimate holding company	24	—	35,261	—
Due from related companies	24	—	7,214	—
Financial investment at fair value through profit or loss	25	—	7,781	—
Tax recoverable		158	217	2,352
Cash and cash equivalents	26	59,924	48,100	45,613
Total current assets		<u>383,567</u>	<u>439,913</u>	<u>433,988</u>

APPENDIX I

ACCOUNTANTS' REPORT

		As at December 31,		
		2015	2016	2017
	Notes	HK\$'000	HK\$'000	HK\$'000
CURRENT LIABILITIES				
Trade and bills payables	27	74,525	69,743	91,624
Accruals and other payables	28	39,835	42,078	59,187
Interest-bearing bank borrowings	29	115,490	130,630	138,800
Tax payable		<u>6,027</u>	<u>3,333</u>	<u>2,349</u>
Total current liabilities		<u>235,877</u>	<u>245,784</u>	<u>291,960</u>
NET CURRENT ASSETS		<u>147,690</u>	<u>194,129</u>	<u>142,028</u>
TOTAL ASSETS LESS CURRENT LIABILITIES		<u>328,801</u>	<u>345,580</u>	<u>289,501</u>
NON-CURRENT LIABILITIES				
Interest-bearing bank borrowings	29	59,344	43,235	52,759
Deferred tax liabilities	30	<u>5,353</u>	<u>5,047</u>	<u>4,682</u>
Total non-current liabilities		<u>64,697</u>	<u>48,282</u>	<u>57,441</u>
Net assets		<u>264,104</u>	<u>297,298</u>	<u>232,060</u>
EQUITY				
Equity attributable to owners of the parent				
Share capital	31	61,753	61,753	61,775
Reserves	32	<u>185,613</u>	<u>217,500</u>	<u>152,394</u>
		247,366	279,253	214,169
Non-controlling interests		<u>16,738</u>	<u>18,045</u>	<u>17,891</u>
Total equity		<u>264,104</u>	<u>297,298</u>	<u>232,060</u>

APPENDIX I

ACCOUNTANTS' REPORT

CONSOLIDATED STATEMENTS OF CHANGES IN EQUITY

		Attributable to owners of the parent									
		Share capital	Share premium account	Contributed surplus	Statutory reserve funds	Exchange fluctuation reserve	Other reserve	Retained profits	Total	Non-controlling interests	Total equity
Notes		HK\$'000	HK\$'000	HK\$'000 (note 32(a))	HK\$'000 (note 32(b))	HK\$'000 (note 32(c))	HK\$'000 (note 32(d))	HK\$'000	HK\$'000	HK\$'000	HK\$'000
		61,753	159,878	—	—	9,488	—	11,905	243,024	18,625	261,649
		—	—	—	—	—	—	41,247	41,247	(1,791)	39,456
		—	—	—	—	(8,758)	—	—	(8,758)	(96)	(8,854)
		—	—	—	—	(8,758)	—	41,247	32,489	(1,887)	30,602
	12	—	—	—	—	—	—	(28,147)	(28,147)	—	(28,147)
		—	—	—	2,557	—	—	(2,557)	—	—	—
		61,753	159,878*	—*	2,557*	730*	—	22,448*	247,366	16,738	264,104
		—	—	—	—	—	—	64,946	64,946	757	65,703
		—	—	—	—	(9,791)	—	—	(9,791)	(116)	(9,907)
		—	—	—	—	(9,791)	—	64,946	55,155	641	55,796
	12	—	—	—	—	—	—	(23,267)	(23,267)	—	(23,267)
	11	—	—	—	—	(1)	—	—	(1)	666	665
		—	—	—	868	—	—	(868)	—	—	—
		61,753	159,878*	—*	3,425*	(9,062)*	—	63,259*	279,253	18,045	297,298
		—	—	—	—	—	—	46,095	46,095	2,279	48,374
		—	—	—	—	11,526	—	—	11,526	—	11,526
		—	—	—	—	11,526	—	46,095	57,621	2,279	59,900
	31	22	—	—	—	—	—	—	22	—	22
	32(a)	—	(159,878)	159,878	—	—	—	—	—	—	—
	12	—	—	(36,300)	—	—	—	(86,645)	(122,945)	—	(122,945)
		—	—	—	—	—	—	—	—	(1,242)	(1,242)
	33	—	—	—	—	—	218	—	218	(1,191)	(973)
		—	—	—	1,026	—	—	(1,026)	—	—	—
		61,775	—*	123,578*	4,451*	2,464*	218*	21,683*	214,169	17,891	232,060

* These reserve accounts comprise the consolidated reserves of HK\$185,613,000, HK\$217,500,000 and HK\$152,394,000 in the consolidated statements of financial position as at December 31, 2015, 2016 and 2017, respectively.

APPENDIX I

ACCOUNTANTS' REPORT

CONSOLIDATED STATEMENTS OF CASH FLOWS

	Notes	Year ended December 31,		
		2015	2016	2017
		HK\$'000	HK\$'000	HK\$'000
CASH FLOWS FROM OPERATING ACTIVITIES				
Profit/(loss) before tax				
From continuing operations		59,430	81,641	64,173
From a discontinued operation		(7,131)	1,465	—
Adjustments for:				
Dividend income from an available-for-sale investment	5	(385)	(519)	—
Interest income		(191)	(590)	(484)
Gain on disposal of a discontinued operation	11	—	(2,665)	—
Finance costs	6	4,875	4,006	4,126
Depreciation		24,969	25,343	22,426
Amortisation of intangible assets	7	2,117	2,114	2,113
Amortisation of prepaid land lease payments	7	413	403	400
Reversal of impairment of an amount due from an associate	7	(43)	—	—
Impairment of trade receivables	7	2,907	681	1,189
Write-off of trade receivables	7	465	280	348
Impairment of goodwill	16	4,914	—	—
Impairment of property, plant and equipment	7	—	1,354	—
(Gain)/loss on disposal of items of property, plant and equipment		(1,356)	491	(1,853)
Write-down of inventories to net realisable value	7	8,424	3,673	1,304
Write-off of inventories		609	2,832	501
		100,017	120,509	94,243
Decrease/(increase) in inventories		41,173	5,763	(45,342)
(Increase)/decrease in trade receivables		(20,908)	2,103	(39,059)
(Increase)/decrease in prepayments, deposits and other receivables		(15,072)	7,590	2,360
(Decrease)/increase in trade and bills payables		(17,229)	(2,494)	19,343
Increase in accruals and other payables		11,329	5,319	14,900
Cash generated from operations		99,310	138,790	46,445

APPENDIX I

ACCOUNTANTS' REPORT

	<i>Notes</i>	Year ended December 31,		
		2015 <i>HK\$'000</i>	2016 <i>HK\$'000</i>	2017 <i>HK\$'000</i>
Cash generated from operations		99,310	138,790	46,445
Hong Kong profits tax paid		(14,144)	(15,994)	(16,770)
Overseas taxes paid		<u>(2,473)</u>	<u>(4,102)</u>	<u>(2,907)</u>
Net cash flows from operating activities		<u>82,693</u>	<u>118,694</u>	<u>26,768</u>
CASH FLOWS FROM INVESTING ACTIVITIES				
Purchases of items of property, plant and equipment		(22,516)	(23,576)	(15,428)
Deposits paid for purchases of items of property, plant and equipment		(619)	(1,439)	(1,218)
Repayment from an associate		43	—	—
Purchases of financial investments at fair value through profit or loss		(45,372)	(47,802)	(6,945)
Proceeds from redemption of financial investments at fair value through profit or loss		45,433	39,685	15,053
Disposal of a discontinued operation	11	—	(180)	—
Advances to related companies		—	(2,145)	(3,135)
Proceeds from disposal of items of property, plant and equipment		2,564	3,042	4,472
Dividend received from an available-for-sale investment		385	519	—
Distribution from an available-for-sale investment		—	7,800	—
Interest income received		130	57	60
Loans to the ultimate holding company		—	(42,849)	—
Advances to the ultimate holding company		<u>—</u>	<u>(45,083)</u>	<u>(19,431)</u>
Net cash flows used in investing activities		<u>(19,952)</u>	<u>(111,971)</u>	<u>(26,572)</u>

APPENDIX I

ACCOUNTANTS' REPORT

	<i>Notes</i>	Year ended December 31,		
		2015 <i>HK\$'000</i>	2016 <i>HK\$'000</i>	2017 <i>HK\$'000</i>
CASH FLOWS FROM FINANCING ACTIVITIES				
Dividends paid		(28,147)	(12,956)	(14,500)
Dividend paid to non-controlling shareholders of a subsidiary		—	—	(1,242)
New bank borrowings		313,257	449,611	458,718
Repayment of bank borrowings		(368,403)	(450,312)	(441,588)
Interest paid		(4,875)	(4,006)	(4,126)
Acquisition of non-controlling interest		—	—	(973)
Proceeds from issue of shares	31	—	—	22
Net cash flows used in financing activities		<u>(88,168)</u>	<u>(17,663)</u>	<u>(3,689)</u>
NET DECREASE IN CASH AND CASH EQUIVALENTS				
		(25,427)	(10,940)	(3,493)
Cash and cash equivalents at the beginning of the year		86,864	59,924	48,100
Effect of foreign exchange rate changes, net		<u>(1,513)</u>	<u>(884)</u>	<u>1,006</u>
CASH AND CASH EQUIVALENTS AT THE END OF THE YEAR		<u><u>59,924</u></u>	<u><u>48,100</u></u>	<u><u>45,613</u></u>
ANALYSIS OF BALANCES OF CASH AND CASH EQUIVALENTS				
Cash and bank balances	26	<u><u>59,924</u></u>	<u><u>48,100</u></u>	<u><u>45,613</u></u>

APPENDIX I

ACCOUNTANTS' REPORT

STATEMENTS OF FINANCIAL POSITION OF THE COMPANY

		As at December 31,		
		2015	2016	2017
	Notes	HK\$'000	HK\$'000	HK\$'000
NON-CURRENT ASSETS				
Investments in subsidiaries	20	<u>78,563</u>	<u>78,563</u>	<u>78,563</u>
CURRENT ASSETS				
Prepayments and deposits	23	—	130	5,056
Due from subsidiaries	20	182,711	168,061	147,374
Cash and cash equivalents	26	7,968	1,478	1,141
Tax recoverable		<u>158</u>	<u>—</u>	<u>625</u>
Total current assets		<u>190,837</u>	<u>169,669</u>	<u>154,196</u>
CURRENT LIABILITIES				
Accruals	28	4,851	1,881	11,536
Due to a subsidiary	20	13	13	—
Tax payable		<u>—</u>	<u>305</u>	<u>—</u>
Total current liabilities		<u>4,864</u>	<u>2,199</u>	<u>11,536</u>
NET CURRENT ASSETS		<u>185,973</u>	<u>167,470</u>	<u>142,660</u>
Net assets		<u><u>264,536</u></u>	<u><u>246,033</u></u>	<u><u>221,223</u></u>
EQUITY				
Share capital	31	61,753	61,753	61,775
Reserves	32	<u>202,783</u>	<u>184,280</u>	<u>159,448</u>
Total equity		<u><u>264,536</u></u>	<u><u>246,033</u></u>	<u><u>221,223</u></u>

II. NOTES TO THE HISTORICAL FINANCIAL INFORMATION

1. CORPORATE AND GROUP INFORMATION

Tsit Wing International Holdings Limited is a limited liability company incorporated in Bermuda. The registered office of the Company is located at Canon's Court, 22 Victoria Street, Hamilton HM 12, Bermuda. The principal place of business of the Company is located at Flats F-J, 11th Floor, Block 1, Kwai Tak Industrial Centre, 15-33 Kwai Tak Street, Kwai Chung, New Territories, Hong Kong. In the opinion of the directors, the immediate holding company and the ultimate holding company of the Company is Hero Valour Limited, which is incorporated in the British Virgin Islands ("BVI").

The Company is an investment holding company. During the Track Record Period, the Company's subsidiaries were involved in the following principal activities:

- processing and sale of coffee, tea and related complementary products
- sale of frozen meat and frozen processed food
- sale and rental of coffee and tea machines
- food and beverage store operations

During the year ended December 31, 2016, the Group ceased the business of manufacturing and distribution of ice-cream. Further details of which are set out to note 11 to the Historical Financial Information.

As at the date of this report, the Company had direct and indirect interests in its subsidiaries, all of which are private limited liability companies (or, if incorporated outside Hong Kong, have substantially similar characteristics to a private company incorporated in Hong Kong), the particulars of which are set out below:

Name	Place and date of incorporation/registration and place of operations	Nominal value of issued ordinary/registered share capital	Percentage of equity attributable to the Company		Principal activities
			Direct	Indirect	
Cadiz Enterprises Limited <i>(note (a))</i>	Hong Kong November 28, 1978	HK\$1,000,000	—	100	Distribution of grocery products
Cadiz (Shenzhen) Caterer Company Limited <i>(note (b))</i>	People's Republic of China ("PRC")/ Mainland China October 19, 2011	HK\$5,000,000	—	100	Trading of coffee machines and related products in Mainland China
Cadiz (Shenzhen) Trading Company Limited <i>(note (b))</i>	PRC/Mainland China July 26, 2012	Renminbi ("RMB") 5,000,000	—	100	Trading of goods in Mainland China
Dongguan Tsit Wing Food Company Limited <i>(note (b))</i>	PRC/Mainland China September 11, 2009	HK\$78,880,000	—	100	Processing of coffee beans; distribution of coffee, tea, and related complementary products; and food and beverage store operation
Dongguan TWG Heritage Food Company Limited <i>(note (b))</i>	PRC/Mainland China January 7, 2014	RMB13,500,000	—	100	Processing of tea products
Global Tea Trading Company Limited <i>(note (a))</i>	Hong Kong September 21, 2012	HK\$10,000	—	100	Inactive
Great Guarder Limited <i>(note (c))</i>	BVI July 3, 2013	United States dollar ("US\$") 1	100	—	Investment holding

APPENDIX I

ACCOUNTANTS' REPORT

Name	Place and date of incorporation/registration and place of operations	Nominal value of issued ordinary/registered share capital	Percentage of equity attributable to the Company		Principal activities
			Direct	Indirect	
Shanghai Tsit Wing Food Company Limited (<i>note (b)</i>)	PRC/Mainland China June 6, 2003	US\$2,400,000	—	100	Trading of coffee, tea and related complementary products; sale and rental of coffee and tea machines; and sale of frozen processed food
Tsit Wing Beverage Machine Company Limited (<i>note (a)</i>)	Hong Kong October 5, 1993	HK\$2	—	100	Trading of coffee machines and related products
Tsit Wing Coffee Company, Limited (<i>note (a)</i>)	Hong Kong December 10, 1992	HK\$10,000	—	100	Processing of coffee beans; distribution of coffee, tea and related complementary products; sale and rental of coffee and tea machines; and sale of frozen processed food
Tsit Wing (China) Caterer Limited (<i>note (a)</i>)	Hong Kong February 22, 2012	HK\$1	—	100	Inactive
Tsit Wing (China) Enterprises Company Limited (<i>note (a)</i>)	Hong Kong June 12, 2002	HK\$2	—	100	Investment holding
Tsit Wing (China) Holdings Limited (<i>note (a)</i>)	Hong Kong February 9, 2011	HK\$1	100	—	Investment holding
Tsit Wing (China) Industrial Company Limited (<i>note (a)</i>)	Hong Kong December 15, 1999	HK\$22,264,780	—	100	Investment holding
Tsit Wing (China) Trading Limited (<i>note (a)</i>)	Hong Kong February 22, 2012	HK\$1	—	100	Investment holding
Tsit Wing Frozen Food Company Limited (<i>note (a)</i>)	Hong Kong August 10, 2012	HK\$10,000	—	100	Inactive
Tsit Wing (Hong Kong) Company Limited (<i>note (a)</i>)	Hong Kong January 3, 1956	HK\$5,143,000	—	100	Investment holding
Tsit Wing (Hong Kong) Frozen Food Company Limited (<i>note (a)</i>)	Hong Kong December 10, 1992	HK\$10,000	—	100	Inactive
Tsit Wing International Company Limited (<i>note (c)</i>)	BVI December 23, 1991	US\$10,276	100	—	Investment holding
Tsit Wing Trademarks And Patent Company Limited (<i>note (c)</i>)	BVI December 21, 1993	US\$1	—	100	Inactive
TWG Heritage Tea Company Limited (<i>note (a)</i>)	Hong Kong December 7, 2012	US\$1,500,000	—	100	Investment holding
Whole Sun Limited (<i>note (a)</i>)	Hong Kong January 7, 2013	HK\$10,000	—	60	Trading of frozen meat

Notes:

- (a) The statutory financial statements of these entities for the year ended December 31, 2015, 2016 and 2017 prepared under HKFRSs were audited by Ernst & Young, Hong Kong.
- (b) These companies are registered as wholly-foreign-owned enterprises under PRC law. The statutory financial statements for the years ended December 31, 2015 and 2016 prepared under PRC Generally Accepted Accounting Principles were audited by 大華會計師事務所(特殊普通合伙)珠海分所, certified public accountants registered in the PRC.
- (c) No statutory financial statements have been prepared for these entities for the years ended December 31, 2015, 2016 and 2017 as these entities were not subject to any statutory audit requirements under the relevant rules and regulations in their jurisdictions of incorporation.

On January 10, 2017, the Group acquired the remaining 20% equity interest in TWG Heritage Tea Company Limited (“TWG Heritage”), thereby increasing its ownership interest from 80% to 100%. Further details are set out in Note 33.

On May 31, 2016, the Group disposed of its 100% equity interest in Elect Gold Ventures Limited and its subsidiaries, namely Dandy Don’s American Ice-Cream Factory Limited, Bofon International Development (Holdings) Limited, Guangzhou Dandy Don’s Ice-cream Factory Company Limited and Dandy Don’s (Guangzhou) Catering Company Limited, to Hero Ace Limited, a company wholly owned by the sole shareholder of the Company for a consideration of USD1. Further details are set out in Note 11.

2.1 BASIS OF PREPARATION

The Historical Financial Information has been prepared in accordance with Hong Kong Financial Reporting Standards (“HKFRSs”) (which include all Hong Kong Financial Reporting Standards, Hong Kong Accounting Standards (“HKASs”) and Interpretations) issued by the HKICPA and accounting principles generally accepted in Hong Kong. All HKFRSs effective for the accounting period commencing from January 1, 2017, together with the relevant transitional provisions, have been early adopted by the Group in the preparation of the Historical Financial Information throughout the Track Record Period.

The Historical Financial Information has been prepared under the historical cost convention except for a financial investment at fair value through profit or loss which has been measured at fair value.

Basis of consolidation

The Historical Financial Information includes the financial statements of the Company and its subsidiaries for the Track Record Period. A subsidiary is an entity (including a structured entity), directly or indirectly, controlled by the Company. Control is achieved when the Group is exposed, or has rights, to variable returns from its involvement with the investee and has the ability to affect those returns through its power over the investee (i.e., existing rights that give the Group the current ability to direct the relevant activities of the investee).

When the Company has, directly or indirectly, less than a majority of the voting or similar rights of an investee, the Group considers all relevant facts and circumstances in assessing whether it has power over an investee, including:

- (a) the contractual arrangement with the other vote holders of the investee;
- (b) rights arising from other contractual arrangements; and
- (c) the Group’s voting rights and potential voting rights.

The financial statements of the subsidiaries are prepared for the same reporting period as the Company, using consistent accounting policies. The results of subsidiaries are consolidated from the date on which the Group obtains control, and continue to be consolidated until the date that such control ceases.

Profit or loss and each component of other comprehensive income are attributed to the owners of the parent of the Group and to the non-controlling interests, even if this results in the non-controlling interests having a deficit balance. All intra-group assets and liabilities, equity, income, expenses and cash flows relating to transactions between members of the Group are eliminated in full on consolidation.

The Group reassesses whether or not it controls an investee if facts and circumstances indicate that there are changes to one or more of the three elements of control described above. A change in the ownership interest of a subsidiary, without a loss of control, is accounted for as an equity transaction.

If the Group loses control over a subsidiary, it derecognises (i) the assets (including goodwill) and liabilities of the subsidiary, (ii) the carrying amount of any non-controlling interest and (iii) the cumulative translation differences recorded in equity; and recognises (i) the fair value of the consideration received, (ii) the fair value of any investment retained and (iii) any resulting surplus or deficit in profit or loss. The Group's share of components previously recognised in other comprehensive income is reclassified to profit or loss or retained profits, as appropriate, on the same basis as would be required if the Group had directly disposed of the related assets or liabilities.

2.2 ISSUED BUT NOT YET EFFECTIVE HONG KONG FINANCIAL REPORTING STANDARDS

The Group has not applied the following new and revised HKFRSs, that have been issued but are not yet effective, in the Historical Financial Information.

Amendments to HKFRS 2	<i>Classification and Measurement of Share-based Payment Transactions</i> ¹
Amendments to HKFRS 4	<i>Applying HKFRS 9 Financial Instruments with HKFRS 4 Insurance Contracts</i> ¹
HKFRS 9	<i>Financial Instruments</i> ¹
Amendments to HKFRS 9	<i>Prepayment Features with Negative Compensation</i> ²
Amendments to HKFRS 10 and HKAS 28 (2011)	<i>Sale or Contribution of Assets between an Investor and its Associate or Joint Venture</i> ⁴
HKFRS 15	<i>Revenue from Contracts with Customers</i> ¹
Amendments to HKFRS 15	<i>Clarifications to HKFRS 15 Revenue from Contracts with Customers</i> ¹
HKFRS 16	<i>Leases</i> ²
HKFRS 17	<i>Insurance Contracts</i> ³
Amendments to HKAS 28	<i>Long-term Interests in Associates and Joint Ventures</i> ²
Amendments to HKAS 40	<i>Transfers of Investment Property</i> ¹
HK(IFRIC)-Int 22	<i>Foreign Currency Transactions and Advance Consideration</i> ¹
HK(IFRIC)-Int 23	<i>Uncertainty over Income Tax Treatments</i> ²
<i>Annual Improvements 2014–2016 Cycle</i>	Amendments to HKFRS 1 and HKAS 28 ¹
<i>Annual Improvements 2015–2017 Cycle</i>	Amendments to a number of HKFRSs issued in February 2018 ²

¹ Effective for annual periods beginning on or after January 1, 2018

² Effective for annual periods beginning on or after January 1, 2019

³ Effective for annual periods beginning on or after January 1, 2021

⁴ No mandatory effective date yet determined but available for early adoption

The Group is in the process of making an assessment of the impact of these new and revised HKFRSs upon initial application. So far, the Group considers that these new and revised HKFRSs may result in changes in accounting policies and are unlikely to have a significant impact on the Group's financial performance and financial position, except as described below.

HKFRS 9 *Financial Instruments*

In September 2014, the HKICPA issued the final version of HKFRS 9, bringing together all phases of the financial instruments project to replace HKAS 39 *Financial Instruments: Recognition and Measurement* and all previous versions of HKFRS 9. The standard introduces new requirements for classification and measurement, impairment and hedge accounting. The Group will adopt HKFRS 9 from 1 January 2018. The Group will not restate comparative information and will recognise any transition adjustments against the opening balance of equity at 1 January 2018. During 2017, the Group has performed an assessment of the impact of the adoption of HKFRS 9. The Group does not expect that the adoption of HKFRS 9 will have a significant impact on the classification and measurement of its financial assets. The expected impacts arising from the adoption of HKFRS 9 relate to the impairment requirements and is summarised as follows:

HKFRS 9 requires an impairment on debt instruments recorded at amortised cost or at fair value through other comprehensive income, lease receivables, loan commitments and financial guarantee contracts that are not accounted for at fair value through profit or loss under HKFRS 9, to be recorded based on an expected credit loss model either on a twelve-month basis or a lifetime basis. The Group will apply the simplified approach and record lifetime expected losses that are estimated based on the present values of all cash shortfalls over the remaining life of all of its trade receivables.

The directors of the Company anticipate that the adoption of HKFRS 9 will have no significant impact on the results and the financial position of the Group.

HKFRS 15 and Amendments to HKFRS 15

HKFRS 15, issued in July 2014, establishes a new five-step model to account for revenue arising from contracts with customers. Under HKFRS 15, revenue is recognised at an amount that reflects the consideration to which an entity expects to be entitled in exchange for transferring goods or services to a customer. The principles in HKFRS 15 provide a more structured approach for measuring and recognising revenue. The standard also introduces extensive qualitative and quantitative disclosure requirements, including disaggregation of total revenue, information about performance obligations, changes in contract asset and liability account balances between periods and key judgements and estimates. The standard will supersede all current revenue recognition requirements under HKFRSs. Either a full retrospective application or a modified retrospective adoption is required on the initial application of the standard. In June 2016, the HKICPA issued amendments to HKFRS 15 to address the implementation issues on identifying performance obligations, application guidance on principal versus agent and licences of intellectual property, and transition. The amendments are also intended to help ensure a more consistent application when entities adopt HKFRS 15 and decrease the cost and complexity of applying the standard. The Group plans to adopt the transitional provisions in HKFRS 15 to recognise the cumulative effect of initial adoption as an adjustment to the opening balance of retained earnings at January 1, 2018. In addition, the Group plans to apply the new requirements only to contracts that are not completed before January 1, 2018. The Group expects that the transitional adjustment to be made on January 1, 2018 upon initial adoption of HKFRS 15 will not be material. During 2017, the Group has performed an assessment on the impact of the adoption of HKFRS 15.

The Group's principal activities consist of the processing and sale of coffee, tea and related complementary products; sale of frozen meat and frozen processed food; sale and rental of coffee and tea machines and food and beverage store operations. The expected impacts arising from the adoption of HKFRS 15 on the Group are summarised as follows:

(a) Sale of goods with rental of machines

The Group provides rental of machines for the sale of coffee and tea products. If customers' purchases of coffee and tea products reach the agreed minimum amount, the rental charge of machine for that month will be waived. Currently, such pricing arrangements are settled monthly or quarterly and the rental of machines is bundled together with the sale of coffee and tea products which is considered not material to the Group's revenue.

The Group has assessed that the rental of machines bundled together with the sale of coffee and tea products are distinct and are considered as separate performance obligations under HKFRS 15. The Group has determined that when HKFRS 15 is adopted, there will be no change to the total revenue.

(b) Presentation and disclosure

The presentation and disclosure requirements in HKFRS 15 are more detailed than those under the current HKAS 18 *Revenue*. The presentation requirements represent a significant change from current practice and will significantly increase the volume of disclosures required in the Group's financial statements. Many of the disclosure requirements in HKFRS 15 are new and the Group has assessed that the impact of some of these disclosure requirements will be significant. In particular, the Group expects that the notes to the financial statements will be expanded because of how the transaction prices have been allocated to the performance obligations, and the assumptions made to estimate the stand-alone selling price of each performance obligation. In addition, as required by HKFRS 15, the Group will disaggregate revenue recognised from contracts with customers into categories that depict how the nature, amount, timing and uncertainty of revenue and cash flows are affected by economic factors. It will also disclose information about the relationship between the disclosure of disaggregated revenue and revenue information disclosed for each reportable segment.

HKFRS 16 Leases

HKFRS 16, issued in May 2016, replaces HKAS 17 *Leases*, HK(IFRIC)-Int 4 *Determining whether an Arrangement contains a Lease*, HK(SIC)-Int 15 *Operating Leases — Incentives* and HK(SIC)-Int 27 *Evaluating the Substance of Transactions Involving the Legal Form of a Lease*. The standard sets out the principles for the recognition, measurement, presentation and disclosure of leases and requires lessees to recognise assets and liabilities for most leases. The standard includes two recognition exemptions for lessees — leases of low-value assets and short-term leases. At the commencement date of a lease, a lessee will recognise a liability to make lease payments (i.e., the lease liability) and an asset representing the right to use the underlying asset during the lease term (i.e., the right-of-use asset). The right-of-use asset is subsequently measured at cost less accumulated depreciation and any impairment losses unless the right-of-use asset meets the definition of investment property in HKAS 40, or relates to a class of property, plant and equipment to which the revaluation model is applied. The lease liability is subsequently increased to reflect the interest on the lease liability and reduced for the lease payments. Lessees will be required to separately recognise the interest expense on the lease liability and the depreciation expense on the right-of-use asset. Lessees will also be required to remeasure the lease liability upon the occurrence of certain events, such as change in the lease term and change in future lease payments resulting from a change in an index or rate used to determine those payments. Lessees will generally recognise the amount of the remeasurement of the lease liability as an adjustment to the right-of-use asset. HKFRS 16 requires lessees and lessors to make more extensive disclosures than under HKAS 17. Lessees can choose to apply the standard using either a full retrospective or a modified retrospective approach. The Group expects to

adopt HKFRS 16 from January 1, 2019. The Group is currently assessing the impact of HKFRS 16 upon adoption and is considering whether it will choose to take advantage of the practical expedients available and which transition approach and reliefs will be adopted.

As set out in note 36 to the Historical Financial Information, the Group's total future minimum lease payments under non-cancellable operating leases as at December 31, 2015, 2016 and 2017 were approximately HK\$18,462,000, HK\$12,691,000 and HK\$17,498,000, respectively. The directors of the Company do not expect the adoption of HKFRS 16 as compared with the current accounting policy would result in a significant impact on the Group's results but it is expected that a certain portion of these lease commitments will be required to be recognised in the consolidated statement of financial position as right-of-use assets and lease liabilities.

2.3 SUMMARY OF SIGNIFICANT ACCOUNTING POLICIES

Investment in an associate

An associate is an entity in which the Group has a long term interest of generally not less than 20% of the equity voting rights and over which it is in a position to exercise significant influence. Significant influence is the power to participate in the financial and operating policy decisions of the investee, but is not control or joint control over those policies.

The Group's investment in an associate is stated in the consolidated statement of financial position at the Group's share of net assets under the equity method of accounting, less any impairment losses.

Adjustments are made to bring into line any dissimilar accounting policies that may exist.

The Group's share of the post-acquisition result and other comprehensive income of an associate is included in the consolidated statement of profit or loss and consolidated other comprehensive income, respectively. In addition, when there has been a change recognised directly in the equity of the associate, the Group recognises its share of any changes, when applicable, in the consolidated statement of changes in equity. Unrealised gains and losses resulting from transactions between the Group and its associate are eliminated to the extent of the Group's investment in the associate, except where unrealised losses provide evidence of an impairment of the asset transferred. Goodwill arising from the acquisition of an associate is included as part of the Group's investment in an associate.

If an investment in an associate becomes an investment in a joint venture or vice versa, the retained interest is not remeasured. Instead, the investment continues to be accounted for under the equity method. In all other cases, upon loss of significant influence over the associate, the Group measures and recognises any retained investment at its fair value. Any difference between the carrying amount of the associate upon loss of significant influence and the fair value of the retained investment and proceeds from disposal is recognised in profit or loss.

Business combinations and goodwill

Business combinations are accounted for using the acquisition method. The consideration transferred is measured at the acquisition date fair value which is the sum of the acquisition date fair values of assets transferred by the Group, liabilities assumed by the Group to the former owners of the acquiree and the equity interests issued by the Group in exchange for control of the acquiree. For each business combination, the Group elects whether to measure the non-controlling interests in the acquiree that are present ownership interests and entitle their holders to a proportionate share of net assets in the event of liquidation at fair value or at the proportionate share of the acquiree's identifiable net assets. All other components of non-controlling interests are measured at fair value. Acquisition-related costs are expensed as incurred.

When the Group acquires a business, it assesses the financial assets and liabilities assumed for appropriate classification and designation in accordance with the contractual terms, economic circumstances and pertinent conditions as at the acquisition date. This includes the separation of embedded derivatives in host contracts of the acquiree.

If the business combination is achieved in stages, the previously held equity interest is remeasured at its acquisition date fair value and any resulting gain or loss is recognised in profit or loss.

Any contingent consideration to be transferred by the acquirer is recognised at fair value at the acquisition date. Contingent consideration classified as an asset or liability is measured at fair value with changes in fair value recognised in profit or loss. Contingent consideration that is classified as equity is not remeasured and subsequent settlement is accounted for within equity.

Goodwill is initially measured at cost, being the excess of the aggregate of the consideration transferred, the amount recognised for non-controlling interests and any fair value of the Group's previously held equity interests in the acquiree over the identifiable net assets acquired and liabilities assumed. If the sum of this consideration and other items is lower than the fair value of the net assets acquired, the difference is, after reassessment, recognised in profit or loss as a gain on bargain purchase.

After initial recognition, goodwill is measured at cost less any accumulated impairment losses. Goodwill is tested for impairment annually or more frequently if events or changes in circumstances indicate that the carrying value may be impaired. The Group performs its annual impairment test of goodwill as at December 31. For the purpose of impairment testing, goodwill acquired in a business combination is, from the acquisition date, allocated to each of the Group's cash-generating units, or groups of cash-generating units, that are expected to benefit from the synergies of the combination, irrespective of whether other assets or liabilities of the Group are assigned to those units or groups of units.

Impairment is determined by assessing the recoverable amount of the cash-generating unit (group of cash-generating units) to which the goodwill relates. Where the recoverable amount of the cash-generating unit (group of cash-generating units) is less than the carrying amount, an impairment loss is recognised. An impairment loss recognised for goodwill is not reversed in a subsequent period.

Where goodwill has been allocated to a cash-generating unit (or group of cash-generating units) and part of the operation within that unit is disposed of, the goodwill associated with the operation disposed of is included in the carrying amount of the operation when determining the gain or loss on the disposal. Goodwill disposed of in these circumstances is measured based on the relative value of the operation disposed of and the portion of the cash-generating unit retained.

Fair value measurement

The Group measures its financial investment at fair value through profit or loss at fair value at the end of each reporting period. Fair value is the price that would be received to sell an asset or paid to transfer a liability in an orderly transaction between market participants at the measurement date. The fair value measurement is based on the presumption that the transaction to sell the asset or transfer the liability takes place either in the principal market for the asset or liability, or in the absence of a principal market, in the most advantageous market for the asset or liability. The principal or the most advantageous market must be accessible by the Group. The fair value of an asset or a liability is measured using the assumptions that market participants would use when pricing the asset or liability, assuming that market participants act in their economic best interest.

A fair value measurement of a non-financial asset takes into account a market participant's ability to generate economic benefits by using the asset in its highest and best use or by selling it to another market participant that would use the asset in its highest and best use.

The Group uses valuation techniques that are appropriate in the circumstances and for which sufficient data are available to measure fair value, maximising the use of relevant observable inputs and minimising the use of unobservable inputs.

All assets and liabilities for which fair value is measured or disclosed in the financial statements are categorised within the fair value hierarchy, described as follows, based on the lowest level input that is significant to the fair value measurement as a whole:

- Level 1 — based on quoted prices (unadjusted) in active markets for identical assets or liabilities
- Level 2 — based on valuation techniques for which the lowest level input that is significant to the fair value measurement is observable, either directly or indirectly
- Level 3 — based on valuation techniques for which the lowest level input that is significant to the fair value measurement is unobservable

For assets and liabilities that are recognised in the financial statements on a recurring basis, the Group determines whether transfers have occurred between levels in the hierarchy by reassessing categorisation (based on the lowest level input that is significant to the fair value measurement as a whole) at the end of each reporting period.

Impairment of non-financial assets

Where an indication of impairment exists, or when annual impairment testing for an asset is required (other than deferred tax assets, inventories and financial assets), the asset's recoverable amount is estimated. An asset's recoverable amount is the higher of the asset's or cash-generating unit's value in use and its fair value less costs of disposal, and is determined for an individual asset, unless the asset does not generate cash inflows that are largely independent of those from other assets or groups of assets, in which case the recoverable amount is determined for the cash-generating unit to which the asset belongs.

An impairment loss is recognised only if the carrying amount of an asset exceeds its recoverable amount. In assessing value in use, the estimated future cash flows are discounted to their present value using a pre-tax discount rate that reflects current market assessments of the time value of money and the risks specific to the asset. An impairment loss is charged to the statement of profit or loss in the period in which it arises in those expense categories consistent with the function of the impaired asset.

An assessment is made at the end of each reporting period as to whether there is an indication that previously recognised impairment losses may no longer exist or may have decreased. If such an indication exists, the recoverable amount is estimated. A previously recognised impairment loss of an asset other than goodwill is reversed only if there has been a change in the estimates used to determine the recoverable amount of that asset, but not to an amount higher than the carrying amount that would have been determined (net of any depreciation/amortisation) had no impairment loss been recognised for the asset in prior years. A reversal of such an impairment loss is credited to the statement of profit or loss in the period in which it arises.

Related parties

A party is considered to be related to the Group if:

- (a) the party is a person or a close member of that person's family and that person
 - (i) has control or joint control over the Group;
 - (ii) has significant influence over the Group; or
 - (iii) is a member of the key management personnel of the Group or of a parent of the Group;or
- (b) the party is an entity where any of the following conditions applies:
 - (i) the entity and the Group are members of the same group;
 - (ii) one entity is an associate or joint venture of the other entity (or of a parent, subsidiary or fellow subsidiary of the other entity);
 - (iii) the entity and the Group are joint ventures of the same third party;
 - (iv) one entity is a joint venture of a third entity and the other entity is an associate of the third entity;
 - (v) the entity is a post-employment benefit plan for the benefit of employees of either the Group or an entity related to the Group;
 - (vi) the entity is controlled or jointly controlled by a person identified in (a);
 - (vii) a person identified in (a)(i) has significant influence over the entity or is a member of the key management personnel of the entity (or of a parent of the entity); and
 - (viii) the entity, or any member of a group of which it is a part, provides key management personnel services to the Group or to the parent of the Group.

Property, plant and equipment and depreciation

Property, plant and equipment, are stated at cost less accumulated depreciation and any impairment losses. The cost of an item of property, plant and equipment comprises its purchase price and any directly attributable costs of bringing the asset to its working condition and location for its intended use.

Expenditure incurred after items of property, plant and equipment have been put into operation, such as repairs and maintenance, is normally charged to the statement of profit or loss in the period in which it is incurred. In situations where the recognition criteria are satisfied, the expenditure for a major inspection is capitalised in the carrying amount of the asset as a replacement. Where significant parts of property, plant and equipment are required to be replaced at intervals, the Group recognises such parts as individual assets with specific useful lives and depreciates them accordingly.

Depreciation is calculated on the straight-line basis to write-off the cost of each item of property, plant and equipment to its residual value over its estimated useful life. The principal annual rates used for this purpose are as follows:

Leasehold land	Over the lease terms
Buildings	Shorter of the lease terms or 2.2%
Plant and machinery	4% to 33.33%
Furniture, fixtures and equipment	20%
Motor vehicles	20%

Where parts of an item of property, plant and equipment have different useful lives, the cost of that item is allocated on a reasonable basis among the parts and each part is depreciated separately. Residual values, useful lives and the depreciation method are reviewed, and adjusted if appropriate, at least at each financial year end.

An item of property, plant and equipment including any significant part initially recognised is derecognised upon disposal or when no future economic benefits are expected from its use or disposal. Any gain or loss on disposal or retirement recognised in the statement of profit or loss in the year the asset is derecognised is the difference between the net sales proceeds and the carrying amount of the relevant asset.

Intangible assets (other than goodwill)

Intangible assets acquired separately are measured on initial recognition at cost. The cost of intangible assets acquired in a business combination is the fair value at the date of acquisition. The useful lives of intangible assets are assessed to be either finite or indefinite. Intangible assets with finite lives are subsequently amortised over the useful economic life and assessed for impairment whenever there is an indication that the intangible asset may be impaired. The amortisation period and the amortisation method for an intangible asset with a finite useful life are reviewed at least at each financial year end.

Customer relationship and trademark are stated at cost less any impairment losses and are amortised on the straight-line basis over their estimated useful lives of 7 and 10 years, respectively

Operating leases

Leases where substantially all the rewards and risks of ownership of assets remain with the lessor are accounted for as operating leases. Where the Group is the lessor, assets leased by the Group under operating leases are included in non-current assets, and rentals receivable under the operating leases are credited to the statement of profit or loss on the straight-line basis over the lease terms. Where the Group is the lessee, rentals payable under operating leases net of any incentives received from the lessor are charged to the statement of profit or loss on the straight-line basis over the lease terms.

Prepaid land lease payments under operating leases are initially stated at cost and subsequently recognised on the straight-line basis over the lease terms.

Investments and other financial assets

Initial recognition and measurement

Financial assets are classified, at initial recognition, as financial assets at fair value through profit or loss, loans and receivables and available-for-sale financial investments, as appropriate. When financial assets are recognised initially, they are measured at fair value plus transaction costs that are attributable to the acquisition of the financial assets, except in the case of financial assets recorded at fair value through profit or loss.

All regular way purchases and sales of financial assets are recognised on the trade date, that is, the date that the Group commits to purchase or sell the asset. Regular way purchases or sales are purchases or sales of financial assets that require delivery of assets within the period generally established by regulation or convention in the marketplace.

Subsequent measurement

The subsequent measurement of financial assets depends on their classification as follows:

Financial assets at fair value through profit or loss

Financial assets at fair value through profit or loss include financial assets held for trading and financial assets designated upon initial recognition as at fair value through profit or loss. Financial assets are classified as held for trading if they are acquired for the purpose of sale in the near term. Derivatives, including separated embedded derivatives, are also classified as held for trading unless they are designated as effective hedging instruments as defined by HKAS 39 *Financial Instruments: Recognition and Measurement* ("HKAS 39").

Financial assets at fair value through profit or loss are carried in the statement of financial position at fair value with positive net changes in fair value presented as other income and gains and negative net changes in fair value presented as finance costs in the statement of profit or loss. These net fair value changes do not include any dividends or interest earned on these financial assets, which are recognised in accordance with the policies set out for "Revenue recognition" below.

Financial assets designated upon initial recognition as at fair value through profit or loss are designated at the date of initial recognition and only if the criteria in HKAS 39 are satisfied.

Loans and receivables

Loans and receivables are non-derivative financial assets with fixed or determinable payments that are not quoted in an active market. After initial measurement, such assets are subsequently measured at amortised cost using the effective interest rate method less any allowance for impairment. Amortised cost is calculated by taking into account any discount or premium on acquisition and includes fees or costs that are an integral part of the effective interest rate. The effective interest rate amortisation is included in the statement of profit or loss. The loss arising from impairment is recognised in the statement of profit or loss.

Available-for-sale financial investments

Available-for-sale financial investments are non-derivative financial assets in listed and unlisted equity investments and debt securities. Equity investments classified as available for sale are those which are neither classified as held for trading nor designated as at fair value through profit or loss. Debt securities in this category are those which are intended to be held for an indefinite period of time and which may be sold in response to needs for liquidity or in response to changes in market conditions.

After initial recognition, available-for-sale financial investments are subsequently measured at fair value, with unrealised gains or losses recognised as other comprehensive income in the available-for-sale investment revaluation reserve until the investment is derecognised, at which time the cumulative gain or loss is recognised in the statement of profit or loss in other income, or until the investment is determined to be impaired, when the cumulative gain or loss is reclassified from the available-for-sale investment revaluation reserve to the statement of profit or loss in other gains or losses. Interest and dividends earned whilst holding the available-for-sale financial investments are

reported as interest income and dividend income, respectively and are recognised in the statement of profit or loss as other income in accordance with the policies set out for “Revenue recognition” below.

When the fair value of unlisted equity investments cannot be reliably measured because (a) the variability in the range of reasonable fair value estimates is significant for that investment or (b) the probabilities of the various estimates within the range cannot be reasonably assessed and used in estimating fair value, such investments are stated at cost less any impairment losses.

The Group evaluates whether the ability and intention to sell its available-for-sale financial assets in the near term are still appropriate. When, in rare circumstances, the Group is unable to trade these financial assets due to inactive markets, the Group may elect to reclassify these financial assets if management has the ability and intention to hold the assets for the foreseeable future or until maturity.

For a financial asset reclassified from the available-for-sale category, the fair value carrying amount at the date of reclassification becomes its new amortised cost and any previous gain or loss on that asset that has been recognised in equity is amortised to profit or loss over the remaining life of the investment using the effective interest rate. Any difference between the new amortised cost and the maturity amount is also amortised over the remaining life of the asset using the effective interest rate. If the asset is subsequently determined to be impaired, then the amount recorded in equity is reclassified to the statement of profit or loss.

Derecognition of financial assets

A financial asset (or, where applicable, a part of a financial asset or part of a group of similar financial assets) is primarily derecognised (i.e., removed from the Group’s consolidated statement of financial position) when:

- the rights to receive cash flows from the asset have expired; or
- the Group has transferred its rights to receive cash flows from the asset or has assumed an obligation to pay the received cash flows in full without material delay to a third party under a “pass-through” arrangement; and either (a) the Group has transferred substantially all the risks and rewards of the asset, or (b) the Group has neither transferred nor retained substantially all the risks and rewards of the asset, but has transferred control of the asset.

When the Group has transferred its rights to receive cash flows from an asset or has entered into a pass-through arrangement, it evaluates if and to what extent it has retained the risk and rewards of ownership of the asset. When it has neither transferred nor retained substantially all the risks and rewards of the asset nor transferred control of the asset, the Group continues to recognise the transferred asset to the extent of the Group’s continuing involvement in the asset. In that case, the Group also recognises an associated liability. The transferred asset and the associated liability are measured on a basis that reflects the rights and obligations that the Group has retained.

Continuing involvement that takes the form of a guarantee over the transferred asset is measured at the lower of the original carrying amount of the asset and the maximum amount of consideration that the Group could be required to repay.

Impairment of financial assets

The Group assesses at the end of each reporting period whether there is objective evidence that a financial asset or a group of financial assets is impaired. An impairment exists if one or more events that occurred after the initial recognition of the asset have an impact on the estimated future cash flows of the financial asset or the group of financial assets that can be reliably estimated. Evidence of impairment may

include indications that a debtor or a group of debtors is experiencing significant financial difficulty, default or delinquency in interest or principal payments, the probability that they will enter bankruptcy or other financial reorganisation and observable data indicating that there is a measurable decrease in the estimated future cash flows, such as changes in arrears or economic conditions that correlate with defaults.

Financial assets carried at amortised cost

For financial assets carried at amortised cost, the Group first assesses whether impairment exists individually for financial assets that are individually significant, or collectively for financial assets that are not individually significant. If the Group determines that no objective evidence of impairment exists for an individually assessed financial asset, whether significant or not, it includes the asset in a group of financial assets with similar credit risk characteristics and collectively assesses them for impairment. Assets that are individually assessed for impairment and for which an impairment loss is, or continues to be, recognised are not included in a collective assessment of impairment.

The carrying amount of the asset is reduced through the use of an allowance account and the loss is recognised in the statement of profit or loss. Interest income continues to be accrued on the reduced carrying amount using the rate of interest used to discount the future cash flows for the purpose of measuring the impairment loss. Loans and receivables together with any associated allowance are written off when there is no realistic prospect of future recovery and all collateral has been realised or has been transferred to the Group.

If, in a subsequent period, the amount of the estimated impairment loss increases or decreases because of an event occurring after the impairment was recognised, the previously recognised impairment loss is increased or reduced by adjusting the allowance account. If a write-off is later recovered, the recovery is credited to the statement of profit or loss.

Assets carried at cost

If there is objective evidence that an impairment loss has been incurred on an unquoted equity instrument that is not carried at fair value because its fair value cannot be reliably measured, or on a derivative asset that is linked to and must be settled by delivery of such an unquoted equity instrument, the amount of the loss is measured as the difference between the asset's carrying amount and the present value of estimated future cash flows discounted at the current market rate of return for a similar financial asset. Impairment losses on these assets are not reversed.

Available-for-sale financial investments

For available-for-sale financial investments, the Group assesses at the end of each reporting period whether there is objective evidence that an investment or a group of investments is impaired.

If an available-for-sale asset is impaired, an amount comprising the difference between its cost (net of any principal payment and amortisation) and its current fair value, less any impairment loss previously recognised in the statement of profit or loss, is removed from other comprehensive income and recognised in the statement of profit or loss.

In the case of equity investments classified as available for sale, objective evidence would include a significant or prolonged decline in the fair value of an investment below its cost. "Significant" is evaluated against the original cost of the investment and "prolonged" against the period in which the fair value has been below its original cost. Where there is evidence of impairment, the cumulative loss — measured as the difference between the acquisition cost and the current fair value, less any impairment loss on that investment previously recognised in the statement of profit or loss — is removed from other comprehensive income and recognised in the

statement of profit or loss. Impairment losses on equity instruments classified as available for sale are not reversed through the statement of profit or loss. Increases in their fair value after impairment are recognised directly in other comprehensive income.

The determination of what is “significant” or “prolonged” requires judgement. In making this judgement, the Group evaluates, among other factors, the duration or extent to which the fair value of an investment is less than its cost.

Financial liabilities

Initial recognition and measurement

Financial liabilities are classified, at initial recognition, as loans and borrowings.

All financial liabilities are recognised initially at fair value and, in the case of loans and borrowings, net of directly attributable transaction costs.

Subsequent measurement

The subsequent measurement of financial liabilities depends on their classification as follows:

Loans and borrowings

After initial recognition, interest-bearing loans and borrowings are subsequently measured at amortised cost, using the effective interest rate method unless the effect of discounting would be immaterial, in which case they are stated at cost. Gains and losses are recognised in the statement of profit or loss when the liabilities are derecognised as well as through the effective interest rate amortisation process.

Amortised cost is calculated by taking into account any discount or premium on acquisition and fees or costs that are an integral part of the effective interest rate. The effective interest rate amortisation is recognised in the statement of profit or loss.

Financial guarantee contracts

Financial guarantee contracts issued by the Group are those contracts that require a payment to be made to reimburse the holder for a loss it incurs because the specified debtor fails to make a payment when due in accordance with the terms of a debt instrument. A financial guarantee contract is recognised initially as a liability at its fair value, adjusted for transaction costs that are directly attributable to the issuance of the guarantee. Subsequent to initial recognition, the Group measures the financial guarantee contract at the higher of: (i) the amount of the best estimate of the expenditure required to settle the present obligation at the end of the reporting period; and (ii) the amount initially recognised less, when appropriate, cumulative amortisation.

Derecognition of financial liabilities

A financial liability is derecognised when the obligation under the liability is discharged or cancelled, or expires.

When an existing financial liability is replaced by another from the same lender on substantially different terms, or the terms of an existing liability are substantially modified, such an exchange or modification is treated as a derecognition of the original liability and a recognition of a new liability, and the difference between the respective carrying amounts is recognised in the statement of profit or loss.

Offsetting of financial instruments

Financial assets and financial liabilities are offset and the net amount is reported in the statement of financial position if there is a currently enforceable legal right to offset the recognised amounts and there is an intention to settle on a net basis, or to realise the assets and settle the liabilities simultaneously.

Derivative financial instruments***Initial recognition and subsequent measurement***

Derivative financial instruments are initially recognised at fair value on the date on which a derivative contract is entered into and are subsequently remeasured at fair value. Derivatives are carried as assets when the fair value is positive and as liabilities when the fair value is negative.

Any gains or losses arising from changes in fair value of derivatives are taken directly to the statement of profit or loss.

Inventories

Inventories are stated at the lower of cost and net realisable value. Cost is determined on the weighted average method and, in the case of work-in-progress and finished goods, comprises direct materials, direct labour and an appropriate proportion of overheads. Net realisable value is based on estimated selling prices less any estimated costs to be incurred to completion and disposal.

Cash and cash equivalents

For the purpose of the consolidated statement of cash flows, cash and cash equivalents comprise cash on hand and demand deposits, and short term highly liquid investments that are readily convertible into known amounts of cash, are subject to an insignificant risk of changes in value, and have a short maturity of generally within three months when acquired, less bank overdrafts which are repayable on demand and form an integral part of the Group's cash management.

For the purpose of the consolidated statement of financial position, cash and cash equivalents comprise cash on hand and at banks, including term deposits, and assets similar in nature to cash, which are not restricted as to use.

Provisions

A provision is recognised when a present obligation (legal or constructive) has arisen as a result of a past event and it is probable that a future outflow of resources will be required to settle the obligation, provided that a reliable estimate can be made of the amount of the obligation.

When the effect of discounting is material, the amount recognised for a provision is the present value at the end of the reporting period of the future expenditures expected to be required to settle the obligation. The increase in the discounted present value amount arising from the passage of time is recognised in the statement of profit or loss.

Income tax

Income tax comprises current and deferred tax. Income tax relating to items recognised outside profit or loss is recognised outside profit or loss, either in other comprehensive income or directly in equity.

Current tax assets and liabilities are measured at the amount expected to be recovered from or paid to the taxation authorities, based on tax rates (and tax laws) that have been enacted or substantively enacted by the end of the reporting period, taking into consideration interpretations and practices prevailing in the countries in which the Group operates.

Deferred tax is provided, using the liability method, on all temporary differences at the end of the reporting period between the tax bases of assets and liabilities and their carrying amounts for financial reporting purposes.

Deferred tax liabilities are recognised for all taxable temporary differences while deferred tax assets are recognised for all deductible temporary differences, the carryforward of unused tax credits and any unused tax losses. Deferred tax assets are recognised to the extent that it is probable that taxable profit will be available against which the deductible temporary differences, the carryforward of unused tax credits and unused tax losses can be utilised.

The carrying amount of deferred tax assets is reviewed at the end of each reporting period and reduced to the extent that it is no longer probable that sufficient taxable profit will be available to allow all or part of the deferred tax asset to be utilised. Unrecognised deferred tax assets are reassessed at the end of each reporting period and are recognised to the extent that it has become probable that sufficient taxable profit will be available to allow all or part of the deferred tax asset to be recovered.

Deferred tax assets and liabilities are measured at the tax rates that are expected to apply to the period when the asset is realised or the liability is settled, based on tax rates (and tax laws) that have been enacted or substantively enacted by the end of the reporting period.

Deferred tax assets and deferred tax liabilities are offset if and only if the Group has a legally enforceable right to set off current tax assets and current tax liabilities and the deferred tax assets and deferred tax liabilities relate to income taxes levied by the same taxation authority on either the same taxable entity or different taxable entities which intend either to settle current tax liabilities and assets on a net basis, or to realise the assets and settle the liabilities simultaneously, in each future period in which significant amounts of deferred tax liabilities or assets are expected to be settled or recovered.

Revenue recognition

Revenue is recognised when it is probable that the economic benefits will flow to the Group and when the revenue can be measured reliably, on the following bases:

- (a) from the sale of goods, when the significant risks and rewards of ownership have been transferred to the buyer, provided that the Group maintains neither managerial involvement to the degree usually associated with ownership, nor effective control over the goods sold;
- (b) rental income, on a time proportion basis over the lease terms;
- (c) food and beverage store operations, when the catering services have been provided to the customers;
- (d) interest income, on an accrual basis using the effective interest method by applying the rate that exactly discounts the estimated future cash receipts over the expected life of the financial instrument or a shorter period, when appropriate, to the net carrying amount of the financial asset; and
- (e) dividend income, when the shareholders' right to receive payment has been established.

Employee benefits***Paid leave carried forward***

The Group provides paid annual leave to its employees under their employment contracts on a calendar year basis. Under certain circumstances, such leave which remains untaken as at the end of the reporting period is permitted to be carried forward and utilised by the respective employees in the following year. An accrual is made at the end of the reporting period for the expected future cost of such paid leave earned during the year by the employees and carried forward.

Pension schemes

The Company continues to operate an occupational retirement scheme registered under the Hong Kong Occupational Retirement Schemes Ordinance. This scheme has been granted exemption pursuant to Section 5 of the Hong Kong Mandatory Provident Fund Schemes Ordinance. Contributions are made based on a percentage of the employees' basic salaries. When an employee leaves the scheme before his/her interest in the Company's employer contributions vesting fully, the ongoing contributions payable by the Company are reduced by the relevant amount of the forfeited employer's contributions.

Since December 2000, the Company has operated a defined contribution Mandatory Provident Fund retirement benefit scheme (the "MPF Scheme") under the Hong Kong Mandatory Provident Fund Schemes Ordinance, for those employees who are eligible to participate in the MPF Scheme. Contributions are made based on a percentage of the employees' basic salaries. The Company's employer contributions vest fully with the employees when contributed into the MPF Scheme.

Contributions from these schemes are charged to the statement of profit or loss as they become payable in accordance with the rules of the schemes. The assets of these schemes are held separately from those of the Company in independently administered funds.

The employees of the Group's subsidiaries which operate in Mainland China are required to participate in a central pension scheme operated by the local municipal government. These subsidiaries are required to contribute a certain percentage of its payroll costs to the central pension scheme. The contributions are charged to the statement of profit or loss as they become payable in accordance with the rules of the central pension scheme.

Dividends

Dividends are simultaneously proposed and declared, because the Company's memorandum of association and Bye-Laws grant the directors the authority to declare dividends. Consequently, dividends are recognised immediately as a liability when they are proposed and declared.

Foreign currencies

The Historical Financial Information is presented in Hong Kong dollars, which is the Company's functional currency. Each entity in the Group determines its own functional currency and items included in the financial statements of each entity are measured using that functional currency. Foreign currency transactions recorded by the entities in the Group are initially recorded using their respective functional currency rates prevailing at the dates of the transactions. Monetary assets and liabilities denominated in foreign currencies are translated at the functional currency rates of exchange ruling at the end of the reporting period. Differences arising on settlement or translation of monetary items are recognised in the statement of profit or loss.

Non-monetary items that are measured in terms of historical cost in a foreign currency are translated using the exchange rates at the dates of the initial transactions. Non-monetary items measured at fair value in a foreign currency are translated using the exchange rates at the date when the fair value

was measured. The gain or loss arising on translation of a non-monetary item measured at fair value is treated in line with the recognition of the gain or loss on change in fair value of the item (i.e., translation difference on the item whose fair value gain or loss is recognised in other comprehensive income or profit or loss is also recognised in other comprehensive income or profit or loss, respectively).

The functional currencies of certain overseas subsidiaries and associates are currencies other than the Hong Kong dollars. As at the end of the reporting period, the assets and liabilities of these entities are translated into Hong Kong dollars at the exchange rates prevailing at the end of the reporting period and their statements of profit or loss are translated into Hong Kong dollars at the weighted average exchange rates for the year.

The resulting exchange differences are recognised in other comprehensive income and accumulated in the exchange fluctuation reserve. On disposal of a foreign operation, the component of other comprehensive income relating to that particular foreign operation is recognised in the statement of profit or loss.

Any goodwill arising on the acquisition of a foreign operation and any fair value adjustments to the carrying amounts of assets and liabilities arising on acquisition are treated as assets and liabilities of the foreign operation and translated at the closing rate.

For the purpose of the consolidated statement of cash flows, the cash flows of overseas subsidiaries are translated into Hong Kong dollars at the exchange rates ruling at the dates of the cash flows. Frequently recurring cash flows of overseas subsidiaries which arise throughout the year are translated into Hong Kong dollars at the weighted average exchange rates for the year.

3. SIGNIFICANT ACCOUNTING JUDGEMENTS AND ESTIMATES

The preparation of the Group's Historical Financial Information requires management to make judgements, estimates and assumptions that affect the reported amounts of revenues, expenses, assets and liabilities, and their accompanying disclosures, and the disclosure of contingent liabilities. Uncertainty about these assumptions and estimates could result in outcomes that could require a material adjustment to the carrying amounts of the assets or liabilities affected in the future.

Estimation uncertainty

The key assumptions concerning the future and other key sources of estimation uncertainty at the end of the reporting period, that have a significant risk of causing a material adjustment to the carrying amounts of assets and liabilities within the next financial year, are described below.

Impairment of goodwill

The Group determines whether goodwill is impaired at least on an annual basis. This requires an estimation of the value in use of the cash-generating units to which the goodwill is allocated. Estimating the value in use requires the Group to make an estimate of the expected future cash flows from the cash-generating units and also to choose a suitable discount rate in order to calculate the present value of those cash flows. Further details are set out in note 16 to the Historical Financial Information.

Impairment of non-financial assets (other than goodwill)

The Group assesses whether there are any indicators of impairment for all non-financial assets at the end of each reporting period. Non-financial assets are tested for impairment when there are indicators that the carrying amounts may not be recoverable. An impairment exists when the carrying value of an asset or a cash-generating unit exceeds its recoverable amount, which is the higher of its fair value less costs of disposal and its value in use. The calculation of the fair value less costs of disposal is based on available data from binding sales transactions in an arm's length transaction of similar assets or observable market

prices less incremental costs for disposing of the asset. When value in use calculations are undertaken, management must estimate the expected future cash flows from the asset or cash-generating unit and choose a suitable discount rate in order to calculate the present value of those cash flows.

Net realisable value of inventories

The Group performs regular review of the carrying amounts of inventories with reference to aged analysis and other specific assessments of the Group's inventories, projections of expected future saleability of goods based on historical sales patterns and other specific attributes, and management experience and judgement. Based on such review, write-down of inventories will be made when the carrying amounts of inventories decline below their estimated net realisable values. Due to changes in market and economic environment and customers' preference, actual saleability of goods and actual selling prices that could be realised might be different from the original estimation and profit or loss could be affected by differences in this estimation.

Impairment of trade receivables

The Group maintains an allowance for estimated loss arising from the inability of its customers to make the required payments. The Group makes its estimates based on the ageing of its trade receivable balances, customers' creditworthiness, and historical write off experience. If the financial condition of its customers was to deteriorate so that the actual impairment loss might be higher than expected, the Group would be required to revise the basis of making the allowance and its future results would be affected.

4. OPERATING SEGMENT INFORMATION

For management purposes, the Group is organised into business units based on their products and services and has two reportable operating segments as follows:

- (a) the beverage solutions ("Beverage Solutions") segment processes and distributes coffee, tea and related complementary products, sells food and beverages, coffee machines and other related products, operates food and beverage store and leases coffee and tea machines; and
- (b) the food products ("Food Products") segment trades frozen meat and frozen processed food.

Management monitors the results of the Group's operating segments separately for the purpose of making decisions about resource allocation and performance assessment. Segment performance is evaluated based on reportable segment profit/loss, which is a measure of adjusted profit/loss before tax. The adjusted profit/loss before tax is measured consistently with the Group's profit before tax except that interest income, dividend income and unallocated gains, head office and corporate expenses as well as finance costs are excluded from such measurement.

Segment assets exclude cash and cash equivalents, balances with related parties, tax recoverable and other unallocated head office and corporate assets as these assets are managed on a group basis.

Segment liabilities exclude interest-bearing bank borrowings other than trust receipt loans, other unallocated head office and corporate liabilities as these liabilities are managed on a group basis.

Intersegment sales and transfers are transacted with reference to the selling prices used for sales made to third parties at the then prevailing market prices.

APPENDIX I

ACCOUNTANTS' REPORT

Year ended December 31, 2015

	Beverage Solutions <i>HK\$'000</i>	Food Products <i>HK\$'000</i>	Total <i>HK\$'000</i>
Segment revenue:			
Sales to external customers	634,723	203,429	838,152
Intersegment sales	<u>—</u>	<u>215</u>	<u>215</u>
	634,723	203,644	838,367
<i>Reconciliation:</i>			
Elimination of intersegment sales			<u>(215)</u>
Revenue from continuing operations			<u>838,152</u>
Segment results	84,057	(5,524)	78,533
<i>Reconciliation:</i>			
Interest income			190
Dividend income and unallocated gains			385
Corporate and unallocated expenses, net			(14,803)
Finance costs			<u>(4,875)</u>
Profit before tax from continuing operations			<u>59,430</u>
Segment assets	395,885	130,081	525,966
<i>Reconciliation:</i>			
Elimination of intersegment receivables			(31,807)
Corporate and unallocated assets			67,387
Assets related to a discontinued operation			<u>3,132</u>
Total assets			<u>564,678</u>
Segment liabilities	130,781	84,743	215,524
<i>Reconciliation:</i>			
Elimination of intersegment payables			(31,807)
Corporate and unallocated liabilities			106,050
Liabilities related to a discontinued operation			<u>10,807</u>
Total liabilities			<u>300,574</u>
Other segment information:			
Depreciation and amortisation	27,195	46	27,241
Impairment of trade receivables	2,304	603	2,907
Reversal of impairment of trade receivables	(346)	—	(346)
Write-off of trade receivables	413	52	465
Write-down of inventories to net realisable value	5,765	2,659	8,424
Write-off of inventories	550	—	550
Capital expenditure*	<u>22,383</u>	<u>67</u>	<u>22,450</u>

* The capital expenditure includes purchases of property, plant and equipment of HK\$21,831,000 and deposits for purchase of property, plant and equipment of HK\$619,000 incurred for continuing operations.

APPENDIX I

ACCOUNTANTS' REPORT

Year ended December 31, 2016

	Beverage Solutions <i>HK\$'000</i>	Food Products <i>HK\$'000</i>	Total <i>HK\$'000</i>
Segment revenue:			
Sales to external customers	639,175	210,545	849,720
Intersegment sales	<u>—</u>	<u>—</u>	<u>—</u>
	639,175	210,545	849,720
<i>Reconciliation:</i>			
Elimination of intersegment sales			<u>—</u>
Revenue from continuing operations			<u><u>849,720</u></u>
Segment results	91,708	1,555	93,263
<i>Reconciliation:</i>			
Interest income			590
Dividend income and other gains			519
Corporate and unallocated expenses, net			(8,725)
Finance costs			<u>(4,006)</u>
Profit before tax from continuing operations			<u><u>81,641</u></u>
Segment assets	366,987	104,472	471,459
<i>Reconciliation:</i>			
Elimination of intersegment receivables			(14,216)
Corporate and unallocated assets			<u>134,121</u>
Total assets			<u><u>591,364</u></u>
Segment liabilities	144,692	62,059	206,751
<i>Reconciliation:</i>			
Elimination of intersegment payables			(14,216)
Corporate and unallocated liabilities			<u>101,531</u>
Total liabilities			<u><u>294,066</u></u>
Other segment information:			
Depreciation and amortisation	27,647	46	27,693
Impairment of property, plant and equipment	1,354	—	1,354
Impairment of trade receivables	676	5	681
Reversal of impairment of trade receivables	(389)	(372)	(761)
Write-off of trade receivables	280	—	280
Write-down of inventories to net realisable value	3,673	—	3,673
Write-off of inventories	2,750	43	2,793
Capital expenditure*	<u>24,915</u>	<u>54</u>	<u>24,969</u>

* The capital expenditure includes purchases of property, plant and equipment of HK\$23,530,000 and deposits for purchase of property, plant and equipment of HK\$1,439,000 incurred for continuing operations.

APPENDIX I

ACCOUNTANTS' REPORT

Year ended December 31, 2017

	Beverage Solutions <i>HK\$'000</i>	Food Products <i>HK\$'000</i>	Total <i>HK\$'000</i>
Segment revenue:			
Sales to external customers	711,349	243,261	954,610
Intersegment sales	<u>—</u>	<u>—</u>	<u>—</u>
	711,349	243,261	954,610
<i>Reconciliation:</i>			
Elimination of intersegment sales			<u>—</u>
Revenue from continuing operations			<u>954,610</u>
Segment results	94,378	10,650	105,028
<i>Reconciliation:</i>			
Interest income			484
Corporate and unallocated expenses, net			(37,213)
Finance costs			<u>(4,126)</u>
Profit before tax from continuing operations			<u>64,173</u>
Segment assets	408,230	127,146	535,376
<i>Reconciliation:</i>			
Elimination of intersegment receivables			(5,210)
Corporate and unallocated assets			<u>51,295</u>
Total assets			<u>581,461</u>
Segment liabilities	168,200	67,573	235,773
<i>Reconciliation:</i>			
Elimination of intersegment payables			(5,210)
Corporate and unallocated liabilities			<u>118,838</u>
Total liabilities			<u>349,401</u>
Other segment information:			
Depreciation and amortisation	24,909	30	24,939
Impairment of trade receivables	1,157	32	1,189
Reversal of impairment of trade receivables	(11)	(6)	(17)
Write-off of trade receivables	348	—	348
Write-down of inventories to net realisable value	628	676	1,304
Write-off of inventories	501	—	501
Capital expenditure*	<u>16,633</u>	<u>13</u>	<u>16,646</u>

* The capital expenditure includes purchases of property, plant and equipment of HK\$15,428,000 and deposits for purchase of property, plant and equipment of HK\$1,218,000 incurred for continuing operations.

APPENDIX I

ACCOUNTANTS' REPORT

Geographical information*(a) Revenue from external customers*

	Year ended December 31,		
	2015	2016	2017
	HK\$'000	HK\$'000	HK\$'000
Hong Kong	612,718	628,620	697,353
Mainland China	205,530	204,295	238,905
Macau	12,067	11,387	11,153
Others	7,837	5,418	7,199
	<u>838,152</u>	<u>849,720</u>	<u>954,610</u>

The revenue information above is based on the locations of the customers.

(b) Non-current assets

	As at December 31,		
	2015	2016	2017
	HK\$'000	HK\$'000	HK\$'000
Hong Kong	78,005	67,204	62,565
Mainland China	94,158	83,360	84,230
	<u>172,163</u>	<u>150,564</u>	<u>146,795</u>

The non-current asset information above is based on the locations of the assets and excludes deferred tax assets and financial assets.

Information about major customers

Revenue from an external customer from continuing operations contributing over 10% to the total revenue of the Group for the years ended December 31, 2015, 2016 and 2017 is as follows:

	Year ended December 31,		
	2015	2016	2017
	HK\$'000	HK\$'000	HK\$'000
Customer A	<u>125,554</u>	<u>119,896</u>	<u>122,596</u>

APPENDIX I

ACCOUNTANTS' REPORT

5. REVENUE AND OTHER INCOME AND GAINS, NET

Revenue represented the net invoiced value of goods sold, rental income received or receivable from the rental of coffee and tea machines and food and beverages operations, after allowances for returns and trade discounts.

An analysis of revenue, and other income and gains, net from continuing operations is as follows:

	Year ended December 31,		
	2015 HK\$'000	2016 HK\$'000	2017 HK\$'000
Revenue			
Sales of goods	834,763	845,342	951,522
Rental income	3,389	3,904	2,729
Food and beverage store operations	—	474	359
	<u>838,152</u>	<u>849,720</u>	<u>954,610</u>
Other income, net			
Bank interest income	129	57	60
Interest income earned from the ultimate holding company	—	489	419
Interest income from financial investment at fair value through profit or loss	61	44	5
Dividend income from an available-for-sale investment	385	519	—
Compensation received from a supplier	3,256	—	—
Compensation from settled litigation (<i>note</i>)	9,958	16,000	—
Others	222	(48)	751
	<u>14,011</u>	<u>17,061</u>	<u>1,235</u>
Gains, net			
Gains on disposal of items of property, plant and equipment, net	1,358	—	1,853
Reversal of impairment of an amount due from an associate	43	—	—
Foreign exchange differences, net	1,865	—	910
	<u>3,266</u>	<u>—</u>	<u>2,763</u>
	<u>17,277</u>	<u>17,061</u>	<u>3,998</u>

Note:

During the Track Record Period, the Group took legal action against defendants for infringement of the Group's registered trademark. On December 3, 2014, the Court of Appeal awarded the judgement in favour of the Group and made an order that the appeal was dismissed with costs. The Group received a compensation from the defendants totalling HK\$9,958,000 during the year ended December 31, 2015. The defendants subsequently lodged an appeal to the Court of Final Appeal. On January 29, 2016, the Court of Final Appeal awarded the judgement in favour of the Group. The full and final settlement of HK\$16,000,000 was received by the Group from the defendants during the year ended December 31, 2016.

APPENDIX I

ACCOUNTANTS' REPORT

6. FINANCE COSTS

An analysis of finance costs is as follows:

	Year ended December 31,		
	2015 <i>HK\$'000</i>	2016 <i>HK\$'000</i>	2017 <i>HK\$'000</i>
Interest on bank borrowings	<u>4,875</u>	<u>4,006</u>	<u>4,126</u>

7. PROFIT BEFORE TAX

The Group's profit before tax from continuing operations is arrived at after charging/(crediting):

	<i>Notes</i>	Year ended December 31,		
		2015 <i>HK\$'000</i>	2016 <i>HK\$'000</i>	2017 <i>HK\$'000</i>
Auditor's remuneration				
Current year provision		1,253	1,312	1,306
Underprovision/(overprovision) in prior years		<u>86</u>	<u>(245)</u>	<u>(15)</u>
		1,339	1,067	1,291
Cost of inventories sold [^]		560,550	542,001	630,789
Listing expenses		—	—	24,974
Depreciation [^]		24,711	25,176	22,426
Amortisation of intangible assets	17	2,117	2,114	2,113
Amortisation of prepaid land lease payments	15	413	403	400
Minimum lease payments under operating leases		9,333	10,073	10,976
Reversal of impairment of an amount due from an associate*		(43)	—	—
Foreign exchange differences, net*		(1,865)	1,333	(910)
Reversal of impairment of trade receivables*	22	(346)	(761)	(17)
Impairment of trade receivables*	22	2,907	681	1,189
Write-off of trade receivables*		465	280	348
Impairment of property, plant and equipment*	14	—	1,354	—
(Gain)/loss on disposal of items of property, plant and equipment*		(1,358)	491	(1,853)

APPENDIX I

ACCOUNTANTS' REPORT

	Notes	Year ended December 31,		
		2015 HK\$'000	2016 HK\$'000	2017 HK\$'000
Employee benefit expenses (including directors' and chief executive's remuneration) (note 8)^:				
Salaries, wages, allowances and bonuses [#]		107,619	114,594	118,181
Pension scheme contributions (defined contribution schemes)		<u>4,549</u>	<u>4,759</u>	<u>5,045</u>
		<u>112,168</u>	<u>119,353</u>	<u>123,226</u>
Write-down of inventories to net realisable value*		8,424	3,673	1,304
Write-off of inventories*		<u>550</u>	<u>2,793</u>	<u>501</u>

* These amounts are included in "Other income and gains, net" or "Other expenses, net" on the face of the consolidated statements of profit or loss.

^ Included in the cost of sales for the years ended December 31, 2015, 2016 and 2017 were cost of inventories sold of HK\$560,550,000, HK\$542,001,000 and HK\$630,789,000, respectively, depreciation charges of HK\$14,563,000, HK\$15,450,000 and HK\$13,944,000, respectively and employee benefit expenses of HK\$8,604,000, HK\$9,671,000 and HK\$10,817,000, respectively.

Included in salaries, wages, allowances and bonuses for the years ended December 31, 2015, 2016 and 2017 were operating lease payments for staff quarters of HK\$2,054,000, HK\$2,372,000 and HK\$2,376,000, respectively.

On December 15, 2017, the Company conditionally adopted a pre-initial public offering share option scheme (the "Pre-IPO Share Option Scheme"), and authorised the directors to grant share options to subscribe for the Company's shares. The Pre-IPO Share Option Scheme, conditional upon the Stock Exchange granting the listing of the shares of the Company, is established for the purpose of providing incentives and rewards to eligible participants to recognise their contribution to the Group. The share options have terms of ten years and vest over three years. Further details of the Pre-IPO Share Option Scheme and the share options granted are set out in the section headed "Pre-IPO Share Option Scheme" in Appendix IV to the Prospectus. No share option has been granted during the year ended December 31, 2017.

APPENDIX I

ACCOUNTANTS' REPORT

8. DIRECTORS' AND CHIEF EXECUTIVE'S REMUNERATION

The remuneration of each of the Company's directors is set out below:

	Fees <i>HK\$'000</i>	Salaries, allowances and benefits in kind <i>HK\$'000</i>	Performance related bonuses <i>HK\$'000</i>	Pension scheme contributions <i>HK\$'000</i>	Total remuneration <i>HK\$'000</i>
Year ended December 31, 2015					
Mr. Wong Tat Tong	—	4,897	316	291	5,504
Mr. Chan Sum Yu Samuel	—	1,342	145	18	1,505
Mr. Wu Kam On Keith	—	1,536	166	18	1,720
	—	7,775	627	327	8,729
Year ended December 31, 2016					
Mr. Wong Tat Tong	—	4,996	494	303	5,793
Mr. Chan Sum Yu Samuel	—	948	—	12	960
Mr. Wu Kam On Keith	—	1,688	335	18	2,041
	—	7,632	829	333	8,794
Year ended December 31, 2017					
Mr. Wong Tat Tong	—	5,081	606	316	6,003
Mr. Wu Kam On Keith	—	1,722	348	18	2,088
Ms. Fan Yee Man	—	408	—	9	417
	—	7,211	954	343	8,508

The Company was incorporated in the Bermuda on June 13, 2000. Mr. Wong Tat Tong and Mr. Wu Kam On Keith were appointed as directors of the Company on July 6, 2000 and January 22, 2010, respectively, and re-designated as executive directors of the Company on September 4, 2017. Mr. Chan Sum Yu Samuel was appointed and resigned as a director of the Company on February 27, 2007 and August 15, 2016, respectively. Ms. Fan Yee Man was appointed as an executive director of the Company on September 4, 2017.

During the Track Record Period, no remuneration was paid or payable by the Group to the directors as an inducement to join or upon joining the Group or as compensation for loss of office.

There was no arrangement under which a director or a chief executive waived or agreed to waive any remuneration during the Track Record Period.

Independent non-executive directors

Mr. Tang Kwai Chang, Mr. Chow Alexander Yue Nong and Mr. Wong Man Fai were appointed as independent non-executive directors of the Company on December 15, 2017.

There were no fees or other emoluments paid or payable to the independent non-executive directors of the Company during the Track Record Period.

9. FIVE HIGHEST PAID EMPLOYEES

The five highest paid employees of the Group during the years ended December 31, 2015 and 2016 included 3 and 2 directors, respectively, while the five highest paid employees of the Group for the year ended December 31, 2017 included 3 directors, among which, a director was appointed on September 4, 2017. Details of the remuneration of the five highest paid employees who are directors are set out in note 8 above. Details of the remuneration for the Track Record Period of the remaining five highest paid employees who are neither a director nor chief executive of the Company (including the remuneration of a director prior to her director appointment on September 4, 2017) are as follows:

	Year ended December 31,		
	2015	2016	2017
	HK\$'000	HK\$'000	HK\$'000
Salaries, allowances and benefits in kind	2,365	3,378	2,832
Performance related bonuses	322	190	579
Pension scheme contributions (defined contribution schemes)	<u>18</u>	<u>36</u>	<u>47</u>
	<u>2,705</u>	<u>3,604</u>	<u>3,458</u>

The number of non-director and non-chief executive highest paid employees whose remuneration fell within the following band during the Track Record Period is as follows:

	Number of employees		
	2015	2016	2017
HK\$1,000,001 to HK\$1,500,000	<u>2</u>	<u>3</u>	<u>3[^]</u>

[^] Included the remuneration of a director of the Company prior to her director appointment on September 4, 2017.

APPENDIX I

ACCOUNTANTS' REPORT

10. INCOME TAX

Pursuant to the rules and regulations of Bermuda, the Group is not subject to any income tax in Bermuda.

Hong Kong profits tax has been provided at the rate of 16.5% on the estimated assessable profits arising in Hong Kong during the Track Record Period. Taxes on profits assessable in Mainland China have been calculated at the rate at 25%.

	Year ended December 31,		
	2015	2016	2017
	HK\$'000	HK\$'000	HK\$'000
Current — Hong Kong			
Charge for the year	12,124	14,224	12,599
Overprovision in prior years	(146)	(686)	(38)
Current — Mainland China			
Charge for the year	2,572	3,652	3,980
(Overprovision)/underprovision in prior years	(24)	192	(59)
Deferred (note 30)	<u>(1,683)</u>	<u>19</u>	<u>(683)</u>
Total tax charge for the year from continuing operations	12,843	17,401	15,799
Total tax charge for the year from a discontinued operation	<u>—</u>	<u>2</u>	<u>—</u>
	<u>12,843</u>	<u>17,403</u>	<u>15,799</u>

A reconciliation of the tax expense applicable to profit before tax at the Hong Kong statutory tax rate to the tax charge at the Group's effective tax rate is as follows:

	Year ended December 31,		
	2015	2016	2017
	HK\$'000	HK\$'000	HK\$'000
Profit before tax from continuing operations	59,430	81,641	64,173
(Loss)/profit before tax from a discontinued operation	<u>(7,131)</u>	<u>1,465</u>	<u>—</u>
	<u>52,299</u>	<u>83,106</u>	<u>64,173</u>
Tax at the Hong Kong statutory tax rate	8,629	13,712	10,589
Higher tax rate enacted by local authority	341	660	1,852
Adjustments in respect of current tax of previous periods	(170)	(494)	(97)
Income not subject to tax	(854)	(558)	(4)
Expenses not deductible for tax	3,135	2,373	5,218
Tax losses utilised from previous periods	(137)	(619)	(2,096)
Recognition of unrecognised tax losses from previous periods	—	—	(166)
Tax losses not recognised	<u>1,899</u>	<u>2,329</u>	<u>503</u>
Tax charge at the Group's effective tax rate	<u>12,843</u>	<u>17,403</u>	<u>15,799</u>

11. DISCONTINUED OPERATION

On May 31, 2016, the Group disposed of its 100% equity interest in Elect Gold Ventures Limited and its subsidiaries ("Elect Gold Group") to Hero Ace Limited, a company wholly owned by Mr. Wong Tat Tong for a consideration of US\$1 (approximately HK\$8). Elect Gold Group engages in the operation of retail shops and the manufacture and wholesale of ice-cream. Following the completion of the transaction on May 31, 2016, the Group discontinued all of its operations in the ice-cream business thereafter. The disposal is a part of the Group's strategic plan to redirect its resources to its core and profitable businesses.

The results of Elect Gold Group for the years ended December 31, 2015 and 2016 (up to date of disposal) are presented below:

	Year ended December 31,	
	2015	2016
	<i>HK\$'000</i>	<i>HK\$'000</i>
Revenue	1,953	888
Cost of sales	<u>(1,339)</u>	<u>(516)</u>
Gross profit	614	372
Other income and gains, net	1	14
Selling and distribution expenses	(770)	(518)
Administrative expenses	(1,689)	(1,028)
Other expenses	(5,287)	(40)
Gain on disposal of a discontinued operation	<u>—</u>	<u>2,665</u>
(Loss)/profit before tax from the discontinued operation	(7,131)	1,465
Income tax expense	<u>—</u>	<u>(2)</u>
(Loss)/profit for the year from the discontinued operation	<u><u>(7,131)</u></u>	<u><u>1,463</u></u>
Attributable to:		
Owners of the parent	(6,762)	1,703
Non-controlling interests	<u>(369)</u>	<u>(240)</u>
	<u><u>(7,131)</u></u>	<u><u>1,463</u></u>

APPENDIX I

ACCOUNTANTS' REPORT

The major classes of assets and liabilities of Elect Gold Group disposed of as at May 31, 2016 (the date of disposal) are as follows:

	May 31, 2016 <i>HK\$'000</i>
<i>Assets</i>	
Property, plant and equipment	1,386
Goodwill	—
Inventories	501
Trade receivables	122
Prepayments, deposits and other receivables	604
Cash and cash equivalents	<u>180</u>
Assets disposed of	<u>2,793</u>
<i>Liabilities</i>	
Trade payables	(59)
Accruals and other payables	<u>(6,064)</u>
Liabilities disposed of	<u>(6,123)</u>
Net liabilities disposed of	<u>(3,330)</u>
Non-controlling interests	666
Exchange fluctuation reserve	<u>(1)</u>
Gain on disposal of a discontinued operation	<u>(2,665)</u>
Satisfied by:	
Cash (US\$1)	<u>HK\$8</u>

An analysis of the net outflow of cash and cash equivalents in respect of the disposal of Elect Gold Group is as follows:

	2016 <i>HK\$'000</i>
Cash consideration	—
Cash and cash equivalents disposed of	<u>(180)</u>
Net cash outflow of cash and cash equivalents in respect of the disposal of a discontinued operation	<u>(180)</u>

APPENDIX I

ACCOUNTANTS' REPORT

The net cash flows incurred by Elect Gold Group for the years ended December 31, 2015 and 2016 (up to the date of disposal) are presented below:

	Year ended December 31,	
	2015	2016
	HK\$'000	HK\$'000
Net cash flows used in operating activities	(2,426)	(866)
Net cash flows used in investing activities	(684)	(46)
Net cash flows from financing activities	<u>3,522</u>	<u>597</u>
Net increase/(decrease) in cash and cash equivalents	<u>412</u>	<u>(315)</u>
	HK\$'cents	HK\$'cents
(Loss)/earnings per share:		
Basic and diluted from the discontinued operation	<u>(1.10)</u>	<u>0.28</u>

The calculations of basic earnings per share from the discontinued operations are based on:

	Year ended December 31,	
	2015	2016
	HK\$'000	HK\$'000
(Loss)/profit attributable to ordinary equity holders of the parent from the discontinued operation	<u>(6,762)</u>	<u>1,703</u>

	Year ended December 31,	
	2015	2016
	'000	'000
Weighted average number of ordinary shares in issue during the year used in the basic earnings per share calculation (note 13)	<u>617,533</u>	<u>617,533</u>

12. DIVIDENDS

The dividends recognised and distributed by the Company during the Track Record Period are as follows:

	Year ended December 31,		
	2015	2016	2017
	HK\$'000	HK\$'000	HK\$'000
2014 final dividend — HK\$0.03 per ordinary share	8,135	—	—
2015 interim dividend — HK\$0.06 per ordinary share	14,693	—	—
2015 special dividend — HK\$0.02 per ordinary share	5,319	—	—
2015 final dividend — HK\$0.05 per ordinary share	—	12,956	—
2016 interim dividend — HK\$0.04 per ordinary share	—	10,311	—
2017 interim dividend — HK\$0.35 per ordinary share	—	—	86,645
2017 special dividend — HK\$0.15 per ordinary share	—	—	36,300
	<u>28,147</u>	<u>23,267</u>	<u>122,945</u>

13. EARNINGS PER SHARE ATTRIBUTABLE TO ORDINARY EQUITY HOLDERS OF THE PARENT

The calculation of the basic earnings per share amounts is based on the profit attributable to ordinary equity holders of the parent and the weighted average number of ordinary shares in issue during the Track Record Period. The weighted average number of ordinary shares used for the earnings per share calculation has been retrospectively adjusted to reflect the share subdivision with effect from September 4, 2017 (note 31).

The calculations of basic earnings per share are based on:

	Year ended December 31,		
	2015	2016	2017
	<i>HK\$'000</i>	<i>HK\$'000</i>	<i>HK\$'000</i>
Earnings			
Profit/(loss) attributable to ordinary equity holders of the parent, used in the basic earnings per share calculation:			
From continuing operations	48,009	63,243	46,095
From a discontinued operation	<u>(6,762)</u>	<u>1,703</u>	<u>—</u>
	<u>41,247</u>	<u>64,946</u>	<u>46,095</u>
	Year ended December 31,		
	2015	2016	2017
	<i>'000</i>	<i>'000</i>	<i>'000</i>
Shares			
Weighted average number of ordinary shares	<u>617,533</u>	<u>617,533</u>	<u>617,604</u>

The Group had no potentially dilutive ordinary shares in issue during the Track Record Period.

APPENDIX I

ACCOUNTANTS' REPORT

14. PROPERTY, PLANT AND EQUIPMENT

	Leasehold land and buildings <i>HK\$'000</i>	Plant and machinery <i>HK\$'000</i>	Furniture, fixtures and equipment <i>HK\$'000</i>	Motor vehicles <i>HK\$'000</i>	Total <i>HK\$'000</i>
December 31, 2015					
At December 31, 2014 and January 1, 2015:					
Cost	42,868	142,842	66,386	6,953	259,049
Accumulated depreciation	<u>(14,032)</u>	<u>(75,066)</u>	<u>(47,694)</u>	<u>(5,221)</u>	<u>(142,013)</u>
Net carrying amount	<u>28,836</u>	<u>67,776</u>	<u>18,692</u>	<u>1,732</u>	<u>117,036</u>
At January 1, 2015, net of accumulated depreciation					
	28,836	67,776	18,692	1,732	117,036
Additions	11,475	17,726	5,275	1,760	36,236
Depreciation provided for the year	(1,406)	(16,185)	(6,678)	(700)	(24,969)
Disposals	—	(1,200)	(8)	—	(1,208)
Exchange realignment	<u>(1,087)</u>	<u>(1,295)</u>	<u>(601)</u>	<u>(13)</u>	<u>(2,996)</u>
At December 31, 2015, net of accumulated depreciation	<u>37,818</u>	<u>66,822</u>	<u>16,680</u>	<u>2,779</u>	<u>124,099</u>
At December 31, 2015:					
Cost	53,086	152,568	70,370	7,534	283,558
Accumulated depreciation	<u>(15,268)</u>	<u>(85,746)</u>	<u>(53,690)</u>	<u>(4,755)</u>	<u>(159,459)</u>
Net carrying amount	<u>37,818</u>	<u>66,822</u>	<u>16,680</u>	<u>2,779</u>	<u>124,099</u>

APPENDIX I

ACCOUNTANTS' REPORT

	Leasehold land and buildings <i>HK\$'000</i>	Plant and machinery <i>HK\$'000</i>	Furniture, fixtures and equipment <i>HK\$'000</i>	Motor vehicles <i>HK\$'000</i>	Total <i>HK\$'000</i>
December 31, 2016					
At December 31, 2015 and January 1, 2016:					
Cost	53,086	152,568	70,370	7,534	283,558
Accumulated depreciation	<u>(15,268)</u>	<u>(85,746)</u>	<u>(53,690)</u>	<u>(4,755)</u>	<u>(159,459)</u>
Net carrying amount	<u><u>37,818</u></u>	<u><u>66,822</u></u>	<u><u>16,680</u></u>	<u><u>2,779</u></u>	<u><u>124,099</u></u>
At January 1, 2016, net of accumulated depreciation					
	37,818	66,822	16,680	2,779	124,099
Additions	65	20,028	2,171	1,423	23,687
Depreciation provided for the year	(1,525)	(17,167)	(5,799)	(852)	(25,343)
Disposals	—	(3,479)	(54)	—	(3,533)
Impairment	—	(1,354)	—	—	(1,354)
Disposal of a discontinued operation (<i>note 11</i>)	—	(531)	(739)	(116)	(1,386)
Exchange realignment	<u>(2,248)</u>	<u>(2,073)</u>	<u>(702)</u>	<u>(18)</u>	<u>(5,041)</u>
At December 31, 2016, net of accumulated depreciation and impairment	<u><u>34,110</u></u>	<u><u>62,246</u></u>	<u><u>11,557</u></u>	<u><u>3,216</u></u>	<u><u>111,129</u></u>
At December 31, 2016:					
Cost	50,523	142,569	68,947	7,916	269,955
Accumulated depreciation and impairment	<u>(16,413)</u>	<u>(80,323)</u>	<u>(57,390)</u>	<u>(4,700)</u>	<u>(158,826)</u>
Net carrying amount	<u><u>34,110</u></u>	<u><u>62,246</u></u>	<u><u>11,557</u></u>	<u><u>3,216</u></u>	<u><u>111,129</u></u>

APPENDIX I

ACCOUNTANTS' REPORT

	Leasehold land and buildings <i>HK\$'000</i>	Plant and machinery <i>HK\$'000</i>	Furniture, fixtures and equipment <i>HK\$'000</i>	Motor vehicles <i>HK\$'000</i>	Total <i>HK\$'000</i>
December 31, 2017					
At December 31, 2016 and January 1, 2017:					
Cost	50,523	142,569	68,947	7,916	269,955
Accumulated depreciation	<u>(16,413)</u>	<u>(80,323)</u>	<u>(57,390)</u>	<u>(4,700)</u>	<u>(158,826)</u>
Net carrying amount	<u>34,110</u>	<u>62,246</u>	<u>11,557</u>	<u>3,216</u>	<u>111,129</u>
At January 1, 2017, net of accumulated depreciation					
	34,110	62,246	11,557	3,216	111,129
Additions	—	12,433	3,346	992	16,771
Depreciation provided for the year	(1,500)	(14,869)	(5,016)	(1,041)	(22,426)
Disposals	—	(2,589)	(30)	—	(2,619)
Exchange realignment	<u>2,359</u>	<u>2,195</u>	<u>586</u>	<u>26</u>	<u>5,166</u>
At December 31, 2017, net of accumulated depreciation and impairment					
	<u>34,969</u>	<u>59,416</u>	<u>10,443</u>	<u>3,193</u>	<u>108,021</u>
At December 31, 2017:					
Cost	53,370	139,227	70,946	8,306	271,849
Accumulated depreciation and impairment	<u>(18,401)</u>	<u>(79,811)</u>	<u>(60,503)</u>	<u>(5,113)</u>	<u>(163,828)</u>
Net carrying amount	<u>34,969</u>	<u>59,416</u>	<u>10,443</u>	<u>3,193</u>	<u>108,021</u>

Included in the Group's leasehold land and buildings were two warehouses with an aggregate carrying value of approximately of HK\$323,000, HK\$157,000 and HK\$16,000 as at December 31, 2015, 2016 and 2017 respectively, for which the Group was not able to obtain the corresponding real estate ownership certificate.

During the year ended December 31, 2016, the Group recorded an impairment loss of HK\$1,354,000 to fully impair the under-utilised plant and machinery. The impairment was recognised in "Other expenses, net" in the statement of profit or loss for the year ended December 31, 2016.

As at December 31, 2016 and December 31, 2017, certain of the Group's buildings with a net carrying amount of approximately HK\$4,158,000 and HK\$3,861,000 were pledged to secure general banking facilities granted to the Group and the ultimate holding company, respectively (notes 29 and 35).

APPENDIX I

ACCOUNTANTS' REPORT

15. PREPAID LAND LEASE PAYMENTS

	As at December 31,		
	2015	2016	2017
	HK\$'000	HK\$'000	HK\$'000
Carrying amount at January 1	14,153	13,101	11,813
Amortised during the year	(413)	(403)	(400)
Exchange realignment	<u>(639)</u>	<u>(885)</u>	<u>933</u>
Carrying amount at the end of the year	13,101	11,813	12,346
Less: Current portion	<u>(413)</u>	<u>(384)</u>	<u>(415)</u>
Non-current portion	<u>12,688</u>	<u>11,429</u>	<u>11,931</u>

Included in the Group's prepaid land lease is a piece of leasehold land (the "Leasehold Land") situated in Mainland China under collective-owned land ownership (集體土地使用) with a carrying value of HK\$4,338,000, HK\$3,911,000 and HK\$4,088,000 as at December 31, 2015, 2016 and 2017 respectively. The Group also had items of property, plant and equipment attached to the Leasehold Land (the "Attached Properties") amounting to HK\$3,777,000, HK\$3,406,000 and HK\$3,560,000 as at December 31, 2015, 2016 and 2017 respectively. The Attached Properties, for which the Group was authorised to obtain the real estate ownership certificates, are mainly served as staff quarters of the Group. To facilitate the Group's future development plan, the Group decided to apply to the relevant Mainland China authorities to change the ownership type of the Leasehold Land from collective-owned land ownership to state-owned land ownership (國有土地使用). During the Track Record Period, the Group has commenced the necessary procedures to change the ownership type of the Leasehold Land in accordance with the Mainland China regulations and returned the land use right certificate for the collective-owned land ownership to the Mainland China government.

Up to the date of the Historical Financial Information, the Group continues to use the Leasehold Land and the Attached Properties without objection from relevant authorities. In the opinion of the directors, having considered the legal advice from the Group's PRC legal advisors, the risk of having to relocate the Group's operation from the Leasehold Land is considered to be relatively low.

16. GOODWILL

	As at December 31,		
	2015	2016	2017
	HK\$'000	HK\$'000	HK\$'000
Cost at January 1, net of accumulated impairment	20,361	15,447	15,447
Impairment during the year	<u>(4,914)</u>	<u>—</u>	<u>—</u>
Carrying amount at the end of the year	<u>15,447</u>	<u>15,447</u>	<u>15,447</u>
At the end of the year			
Cost	20,361	15,447	15,447
Accumulated impairment	<u>(4,914)</u>	<u>—</u>	<u>—</u>
Net carrying amount	<u>15,447</u>	<u>15,447</u>	<u>15,447</u>

Impairment testing of goodwill

Goodwill arose from the Group's acquisition of the frozen food business in Hong Kong and the production and wholesale of ice-cream business in Mainland China. Goodwill acquired through business combinations is allocated to the following cash-generating units for impairment testing:

- Trading of frozen food cash-generating unit; and
- Ice-cream products cash-generating unit

The carrying amount of goodwill allocated to each of the cash-generating units is as follows:

	As at December 31,		
	2015 HK\$'000	2016 HK\$'000	2017 HK\$'000
Trading of frozen food	15,447	15,447	15,447
Ice cream products	<u>—</u>	<u>—</u>	<u>—</u>
	<u>15,447</u>	<u>15,447</u>	<u>15,447</u>

Trading of frozen foods cash-generating unit

The recoverable amount of the trading of frozen foods cash-generating unit for the Track Record Period has been determined based on a value in use calculation using cash flow projections based on financial budgets covering a three-year period approved by management. The discount rate applied to the cash flow projections is 15.0%. The growth rate used to extrapolate the cash flows of the industrial products unit beyond the three-year period is 1.5% which was the same as the long term average growth rate of the trading of frozen foods market.

Ice-cream products cash-generating unit

During the year ended December 31, 2015, the recoverable amount of the ice-cream products cash-generating unit was determined based on a value in use calculation using cash flow projections based on financial budgets covering a three-year period approved by management. The discount rates applied to the cash flow projections for the year ended December 31, 2015 was 17.0% and cash flows beyond the three-year period were extrapolated using a growth rate of 3%, which was the same as the long term average growth rate of the ice-cream industry. Based on the annual impairment test performed for the year ended December 31, 2015, an impairment loss of HK\$4,914,000 had been provided in relation to the ice-cream products cash-generating unit. The impairment loss was a result of poor performance and from keen competition of ice-cream products in the Mainland China market.

During the year ended December 31, 2016, the Group disposed of its ice-cream business. Accordingly, the gross carrying amount of goodwill allocated to the ice-cream products cash-generating unit amounting to HK\$4,914,000 and the related accumulated impairment of the same amount were derecognised during the year.

APPENDIX I

ACCOUNTANTS' REPORT

Assumptions were used in the value in use calculation of the trading of frozen foods and ice-cream products cash-generating units for the Track Record Period. The following describes each key assumption on which management has based its cash flow projections to undertake impairment testing of goodwill:

Budgeted gross margins — The basis used to determine the value assigned to the budgeted gross margins is the average gross margins achieved in the year immediately before the budget year, increased for expected efficiency improvements, and expected market development.

Discount rates — The discount rates used are before tax and reflect specific risks relating to the relevant units.

In the opinion of the Directors, any reasonably possible changes in the key assumptions on which the recoverable amount is based would not cause the relevant cash generating unit's carrying amount to exceed its recoverable amount.

17. INTANGIBLE ASSETS

	Trademark <i>HK\$'000</i>	Customer relationship <i>HK\$'000</i>	Total <i>HK\$'000</i>
December 31, 2015			
At January 1, 2015			
Cost	1,225	14,000	15,225
Accumulated amortisation	<u>(142)</u>	<u>(3,667)</u>	<u>(3,809)</u>
Net carrying amount	<u>1,083</u>	<u>10,333</u>	<u>11,416</u>
Cost at January 1, 2015, net of accumulated amortisation			
	1,083	10,333	11,416
Amortisation provided during the year	(117)	(2,000)	(2,117)
Exchange realignment	<u>(49)</u>	<u>—</u>	<u>(49)</u>
At December 31, 2015	<u>917</u>	<u>8,333</u>	<u>9,250</u>
At December 31, 2015			
Cost	1,170	14,000	15,170
Accumulated amortisation	<u>(253)</u>	<u>(5,667)</u>	<u>(5,920)</u>
Net carrying amount	<u>917</u>	<u>8,333</u>	<u>9,250</u>
December 31, 2016			
Cost at January 1, 2016, net of accumulated amortisation			
	917	8,333	9,250
Amortisation provided during the year	(114)	(2,000)	(2,114)
Exchange realignment	<u>(58)</u>	<u>—</u>	<u>(58)</u>
At December 31, 2016	<u>745</u>	<u>6,333</u>	<u>7,078</u>
At December 31, 2016			
Cost	1,089	14,000	15,089
Accumulated amortisation	<u>(344)</u>	<u>(7,667)</u>	<u>(8,011)</u>
Net carrying amount	<u>745</u>	<u>6,333</u>	<u>7,078</u>

APPENDIX I

ACCOUNTANTS' REPORT

	Trademark <i>HK\$'000</i>	Customer relationship <i>HK\$'000</i>	Total <i>HK\$'000</i>
December 31, 2017			
Cost at January 1, 2017, net of accumulated amortisation	745	6,333	7,078
Amortisation provided during the year	(113)	(2,000)	(2,113)
Exchange realignment	55	—	55
At December 31, 2017	<u>687</u>	<u>4,333</u>	<u>5,020</u>
At December 31, 2017			
Cost	1,176	14,000	15,176
Accumulated amortisation	(489)	(9,667)	(10,156)
Net carrying amount	<u>687</u>	<u>4,333</u>	<u>5,020</u>

18. INVESTMENT IN AN ASSOCIATE

	As at December 31,		
	2015 <i>HK\$'000</i>	2016 <i>HK\$'000</i>	2017 <i>HK\$'000</i>
Unlisted investment in an associate, at cost	218	218	—
Share of post-acquisition losses and other comprehensive losses	(218)	(218)	—
Share of net assets	—	—	—
Due from an associate	272	272	—
Provision for impairment	(272)	(272)	—
	<u>—</u>	<u>—</u>	<u>—</u>

An impairment was recognised for an amount due from an associate with a carrying amount of HK\$272,000, HK\$272,000 and nil as at December 31, 2015, 2016 and 2017 (before deducting the impairment loss), respectively, because the associate has been making losses. The amount due from an associate was unsecured and are repayable on demand.

Particulars of the associate are set out as follows:

Names	Particulars of issued shares held	Place of incorporation and business	Proportion of ownership interest attributable to the Group	Principal activities
eDining Holdings Limited	US\$80,000	British Virgin Islands/ Hong Kong	35%	Investment holding

APPENDIX I

ACCOUNTANTS' REPORT

The Group has discontinued the recognition of its share of losses of eDining Holdings Limited since the year ended December 31, 2014 because the share of losses of the associate exceeded the Group's interest in the associate and the Group has no obligation to take up further losses. The amounts of the Group's unrecognised share of losses of this associate for the years ended December 31, 2015 and 2016 were HK\$5,000 and HK\$11,000, respectively, and cumulatively were HK\$118,000 and HK\$129,000, respectively.

During the year ended December 31, 2017, eDining Holdings Limited applied voluntary liquidation to the Registrar of Companies in the BVI. Accordingly, the gross carrying amount of the amount due from an associate of HK\$272,000 and the related accumulated impairment of the same amount were written-off during the period. eDining Holdings Limited was liquidated on May 11, 2017.

19. AVAILABLE-FOR-SALE INVESTMENT

	As at December 31,		
	2015	2016	2017
	<i>HK\$'000</i>	<i>HK\$'000</i>	<i>HK\$'000</i>
Unlisted equity investment, at cost	7,800	—	—

The unlisted equity investment represented the Group's 16.39% equity interest in Wonder (Asia) Holdings Limited ("Wonder (Asia)"), a company incorporated in the BVI. Wonder (Asia) is an investment holding company which owns investments in entities with the food and beverage retail business in Mainland China. The investment was designated as an available-for-sale investment financial asset and has no fixed maturity date or coupon rate.

As at December 31, 2015, the unlisted equity investment was stated at cost less impairment because the range of reasonable fair value estimates was so significant that the directors are of the opinion that its fair value could not be measured reliably.

During the year ended December 31, 2016, Wonder (Asia) disposed of its operation to an independent third party. Following the completion of the disposal, Wonder (Asia) made distributions of the gain arising therefrom to the existing shareholders and amongst which, the Group received a distribution of HK\$8,319,000. Accordingly, the Group recorded the distribution to the extent of HK\$7,800,000 as return of capital and derecognised its investment cost of HK\$7,800,000 in Wonder (Asia). The remaining distribution of HK\$519,000 was recognised as dividend income in profit or loss during the year ended December 31, 2016. Subsequent to December 31, 2016, Wonder (Asia) applied voluntary liquidation to the Registrar of Companies in the BVI.

20. INVESTMENTS IN SUBSIDIARIES

	As at December 31,		
	2015	2016	2017
	<i>HK\$'000</i>	<i>HK\$'000</i>	<i>HK\$'000</i>
Company			
Unlisted shares, at cost	78,563	78,563	78,563

Particulars of the subsidiaries are disclosed in note 1 to the Historical Financial Information.

The balances with subsidiaries are unsecured, interest-free and are repayable on demand.

APPENDIX I

ACCOUNTANTS' REPORT

21. INVENTORIES

	As at December 31,		
	2015	2016	2017
	HK\$'000	HK\$'000	HK\$'000
Raw materials	46,987	50,277	79,024
Work-in-progress	149	292	749
Finished goods	<u>116,515</u>	<u>96,658</u>	<u>115,597</u>
	<u>163,651</u>	<u>147,227</u>	<u>195,370</u>

22. TRADE RECEIVABLES

	As at December 31,		
	2015	2016	2017
	HK\$'000	HK\$'000	HK\$'000
Trade receivables	138,512	131,877	174,571
Impairment	<u>(3,348)</u>	<u>(2,954)</u>	<u>(4,218)</u>
	<u>135,164</u>	<u>128,923</u>	<u>170,353</u>

The Group's trading terms with its customers are mainly on credit, except for new customers, where the Group normally trades in cash on delivery. The credit periods generally range from 30 to 120 days. Each customer has a maximum credit limit. The Group seeks to maintain strict control over its outstanding receivables and has a credit control team to minimise credit risk. Overdue balances are reviewed regularly by management. The Group does not hold any collateral or other credit enhancements over its trade receivable balances. Trade receivables are non-interest-bearing.

An aging analysis of the trade receivables as at the end of each of the Track Record Period, based on the invoice date and net of provisions, is as follows:

	As at December 31,		
	2015	2016	2017
	HK\$'000	HK\$'000	HK\$'000
Within 30 days	80,459	77,675	101,908
31 to 60 days	35,553	34,187	40,149
61 to 90 days	8,696	9,160	15,058
91 to 180 days	8,849	6,934	11,509
181 to 360 days	724	755	1,649
Over 360 days	<u>883</u>	<u>212</u>	<u>80</u>
	<u>135,164</u>	<u>128,923</u>	<u>170,353</u>

APPENDIX I

ACCOUNTANTS' REPORT

The movements in provision for impairment of trade receivables are as follows:

	As at December 31,		
	2015	2016	2017
	HK\$'000	HK\$'000	HK\$'000
At beginning of year	800	3,348	2,954
Impairment losses recognised (<i>note 7</i>)	2,907	681	1,189
Impairment losses reversed (<i>note 7</i>)	(346)	(761)	(17)
Amount written off as uncollectible	—	(233)	—
Exchange realignment	(13)	(81)	92
	<u>3,348</u>	<u>2,954</u>	<u>4,218</u>

At December 31, 2015, 2016 and 2017, the above provision for impairment of trade receivables is a provision for individually and collectively impaired trade receivables of HK\$3,348,000, HK\$2,954,000 and HK\$4,218,000 with carrying amounts before provision of HK\$13,853,000, HK\$9,358,000 and HK\$15,246,000, respectively. The individually impaired trade receivables relate to customers that were in financial difficulties and none or only a portion of the receivables is expected to be recovered.

The aging analysis of the trade receivables that are not individually nor collectively considered to be impaired is as follows:

	As at December 31,		
	2015	2016	2017
	HK\$'000	HK\$'000	HK\$'000
Neither past due nor impaired	111,774	108,946	145,529
Less than 30 days past due	<u>12,885</u>	<u>13,573</u>	<u>13,796</u>
	<u>124,659</u>	<u>122,519</u>	<u>159,325</u>

Trade receivables that were neither past due nor impaired relate to a large number of diversified customers for whom there was no recent history of default.

Trade receivables that were past due but not impaired relate to a number of independent customers that have a good track record with the Group. Based on past experience, the directors of the Company are of the opinion that no provision for impairment is necessary in respect of these balances as there has not been a significant change in their credit quality and the balances are still considered fully recoverable.

APPENDIX I

ACCOUNTANTS' REPORT

23. PREPAYMENTS, DEPOSITS AND OTHER RECEIVABLES

	As at December 31,		
	2015	2016	2017
	<i>HK\$'000</i>	<i>HK\$'000</i>	<i>HK\$'000</i>
Group			
Deposits	3,053	3,191	3,862
Prepayments	24,832	18,952	17,891
Other receivables	<u>5,995</u>	<u>3,120</u>	<u>1,748</u>
	33,880	25,263	23,501
Less: Non-current portion	<u>(9,623)</u>	<u>(3,306)</u>	<u>(3,616)</u>
Current portion	<u><u>24,257</u></u>	<u><u>21,957</u></u>	<u><u>19,885</u></u>
	As at December 31,		
	2015	2016	2017
	<i>HK\$'000</i>	<i>HK\$'000</i>	<i>HK\$'000</i>
Company			
Deposits	—	—	1,000
Prepayments	<u>—</u>	<u>130</u>	<u>4,056</u>
	<u><u>—</u></u>	<u><u>130</u></u>	<u><u>5,056</u></u>

None of the above assets is either past due or impaired. The financial assets included in the above balances relate to deposits and receivables for which there was no recent history of default.

APPENDIX I

ACCOUNTANTS' REPORT

24. BALANCES WITH RELATED COMPANIES AND THE ULTIMATE HOLDING COMPANY

The balances with related companies and the ultimate holding company are non-trade related, unsecured and are repayable on demand. Except for the loans to the ultimate holding company as at December 31, 2016 of HK\$42,849,000 which bore interest at the Hong Kong Interbank Offered Rate plus 1.5% per annum, the remaining balances are interest-free.

Particulars of the amounts due from related companies which are under common control of Mr. Wong Tat Tong, the sole shareholder and a director of the Company, are as follows:

December 31, 2016

	At December 31, 2016 <i>HK\$'000</i>	Maximum amount outstanding during the year <i>HK\$'000</i>	At January 1, 2016 <i>HK\$'000</i>
Due from related companies:			
Bofon International Development (Holdings) Limited	20	20	—
Dandy Don's American Ice-cream Factory Limited	744	744	—
Dandy Don's (Guangzhou) Catering Co Ltd	1,024	1,024	—
Guangzhou Dandy Don's Ice-cream Factory Company Ltd	<u>5,426</u>	<u>5,426</u>	<u>—</u>
	<u>7,214</u>	<u>7,214</u>	<u>—</u>

December 31, 2017

	At December 31, 2017 <i>HK\$'000</i>	Maximum amount outstanding during the year <i>HK\$'000</i>	At January 1, 2017 <i>HK\$'000</i>
Due from related companies:			
Bofon International Development (Holdings) Limited	—	20	20
Dandy Don's American Ice-cream Factory Limited	—	744	744
Dandy Don's (Guangzhou) Catering Co Ltd	—	3,092	1,024
Guangzhou Dandy Don's Ice-cream Factory Ltd	<u>—</u>	<u>6,629</u>	<u>5,426</u>
	<u>—</u>	<u>10,485</u>	<u>7,214</u>

25. FINANCIAL INVESTMENT AT FAIR VALUE THROUGH PROFIT OR LOSS

Financial investment at fair value through profit or loss represents a structured deposit which was placed with a bank in Mainland China. The principal amount of the structured deposit is RMB7,000,000 as at December 31, 2016 with maturity on January 3, 2017 (December 31, 2015 and December 31, 2016: Nil). The Group designated the structured deposit as an investment at fair value through profit or loss in accordance with HKAS 39.

As at December 31, 2016, the fair value of the structured deposit was HK\$7,781,000 (December 31, 2015 and 2017: Nil) and total realised and unrealised fair value gains of HK\$61,000, HK\$44,000 and HK\$5,000 were recognised by the Group during the years ended December 31, 2015, 2016 and 2017, respectively. The fair value was based on the market values provided by the financial institution as at December 31, 2016.

26. CASH AND CASH EQUIVALENTS

	As at December 31,		
	2015 <i>HK\$'000</i>	2016 <i>HK\$'000</i>	2017 <i>HK\$'000</i>
Group			
Cash and bank balances	59,924	48,100	45,613
	As at December 31,		
	2015 <i>HK\$'000</i>	2016 <i>HK\$'000</i>	2017 <i>HK\$'000</i>
Company			
Bank balances	7,968	1,478	1,141

At December 31, 2015, 2016 and 2017, the cash and bank balances of the Group denominated in RMB amounted to HK\$20,337,000, HK\$13,097,000 and HK\$13,660,000, respectively. The RMB is not freely convertible into other currencies, however, under Mainland China's Foreign Exchange Control Regulations and Administration of Settlement, Sale and Payment of Foreign Exchange Regulations, the Group is permitted to exchange RMB for other currencies through banks authorised to conduct foreign exchange business.

Cash at banks earns interest at floating rates based on daily bank deposit rates. The bank balances are deposited with creditworthy banks with no recent history of default.

APPENDIX I

ACCOUNTANTS' REPORT

27. TRADE AND BILLS PAYABLES

	As at December 31,		
	2015	2016	2017
	HK\$'000	HK\$'000	HK\$'000
Trade payables	72,380	68,669	90,318
Bills payable	<u>2,145</u>	<u>1,074</u>	<u>1,306</u>
	<u>74,525</u>	<u>69,743</u>	<u>91,624</u>

An aging analysis of the trade and bills payables as at the end of each reporting period, based on the invoice date, is as follows:

	As at December 31,		
	2015	2016	2017
	HK\$'000	HK\$'000	HK\$'000
Within 1 month	67,529	62,480	85,996
1 to 2 months	911	856	3,593
2 to 3 months	187	324	420
Over 3 months	<u>5,898</u>	<u>6,083</u>	<u>1,615</u>
	<u>74,525</u>	<u>69,743</u>	<u>91,624</u>

The trade payables are non-interest-bearing and are normally settled within 30 to 60 days. The bills payable have a maturity period of 120 days.

28. ACCRUALS AND OTHER PAYABLES

	As at December 31,		
	2015	2016	2017
	HK\$'000	HK\$'000	HK\$'000
Group			
Accruals	29,456	32,766	49,387
Receipts in advance	4,018	2,631	2,676
Other payables	<u>6,361</u>	<u>6,681</u>	<u>7,124</u>
	<u>39,835</u>	<u>42,078</u>	<u>59,187</u>

	As at December 31,		
	2015	2016	2017
	HK\$'000	HK\$'000	HK\$'000
Company			
Accruals	<u>4,851</u>	<u>1,881</u>	<u>11,536</u>

Other payables are non-interest-bearing and have an average term of three months.

APPENDIX I

ACCOUNTANTS' REPORT

29. INTEREST-BEARING BANK BORROWINGS

	December 31, 2015			December 31, 2016			December 31, 2017		
	Effective interest rate (%)	Maturity	HK\$'000	Effective interest rate (%)	Maturity	HK\$'000	Effective interest rate (%)	Maturity	HK\$'000
Current									
Trust receipt loans —									
unsecured	1.73–2.23	2016	73,839	1.80–3.80	2017	74,516	2.06–3.80	2018	84,245
Bank loans —		On			On			On	
unsecured	1.73–2.60	demand	7,988	1.80–2.05	demand	18,000	2.06–2.56	demand	38,000
Current portion of long term bank loans —									
unsecured	2.60–2.73	2016	33,663	2.70–2.80	2017	10,529	2.31–3.06	2018	11,355
Current portion of long term bank loans —									
secured	—	—	—	2.70	2017	27,585	2.96	2018	5,200
			<u>115,490</u>			<u>130,630</u>			<u>138,800</u>
Non-current									
Bank loans —									
unsecured	2.60–2.73	2017–2018	59,344	2.70–2.80	2018–2021	8,754	2.31–3.06	2019–2020	36,292
Bank loans — secured	—	—	—	2.70	2018–2019	34,481	2.96	2019–2020	16,467
			<u>59,344</u>			<u>43,235</u>			<u>52,759</u>
			<u>174,834</u>			<u>173,865</u>			<u>191,559</u>

Note:

Certain term loans of the Group containing repayment on demand clauses as at December 31, 2015, 2016 and 2017 with carrying amounts of HK\$7,988,000, HK\$18,000,000 and HK\$38,000,000, respectively, have been classified in total as current liabilities. Accordingly, portions of the bank loans due for repayment after one year as at December 31, 2015, 2016 and 2017 with carrying amounts of HK\$1,931,000, Nil and Nil, respectively, have been classified as current liabilities. For the purpose of the above analysis, the loans are included within current interest-bearing bank borrowings and analysed into bank loans repayable within one year or on demand.

Ignoring the effect of any repayment on demand clause and based on the maturity terms of these term loans, the Group's bank and other borrowings are repayable:

	As at December 31,		
	2015 HK\$'000	2016 HK\$'000	2017 HK\$'000
Within one year	113,559	130,630	138,800
In the second year	36,147	35,739	16,668
In the third to fifth years, inclusive	<u>25,128</u>	<u>7,496</u>	<u>36,091</u>
	<u>174,834</u>	<u>173,865</u>	<u>191,559</u>

- (a) Certain of the Group's banking facilities are secured by the pledge of certain of the Group's buildings with a net carrying amount of HK\$4,158,000 and HK\$3,861,000 as at December 31, 2016 and 2017, respectively (note 14).

- (b) As at December 31, 2015, 2016 and 2017, certain of the Group's bank borrowings are guaranteed by Mr. Wong Tat Tong up to an aggregate guarantee amount of HK\$532,258,000, HK\$471,506,000 and HK\$155,333,000, respectively.

30. DEFERRED TAX

The movements in deferred tax assets and liabilities during the Track Record Period are as follows:

Deferred tax liabilities

	Depreciation allowance in excess of related depreciation <i>HK\$'000</i>	Fair value adjustment arising from acquisition of a business <i>HK\$'000</i>	Total <i>HK\$'000</i>
At January 1, 2015	4,728	1,705	6,433
Deferred tax credited to the consolidated statement of profit or loss during the year (<i>note 10</i>)	<u>(229)</u>	<u>(330)</u>	<u>(559)</u>
At December 31, 2015 and January 1, 2016	4,499	1,375	5,874
Deferred tax credited to the consolidated statement of profit or loss during the year (<i>note 10</i>)	<u>(491)</u>	<u>(330)</u>	<u>(821)</u>
At December 31, 2016 and January 1, 2017	4,008	1,045	5,053
Deferred tax credited to the consolidated statement of profit or loss during the year (<i>note 10</i>)	<u>(41)</u>	<u>(330)</u>	<u>(371)</u>
At December 31, 2017	<u><u>3,967</u></u>	<u><u>715</u></u>	<u><u>4,682</u></u>

APPENDIX I

ACCOUNTANTS' REPORT

The movements in deferred tax assets and liabilities during the Track Record Period are as follows:

Deferred tax assets

	Depreciation in excess of related depreciation allowance <i>HK\$'000</i>	Allowance for doubtful debts <i>HK\$'000</i>	Allowance for obsolete inventories <i>HK\$'000</i>	Losses available for offsetting against future taxable profits <i>HK\$'000</i>	Unrealised profit resulting from intragroup transactions <i>HK\$'000</i>	Total <i>HK\$'000</i>
At January 1, 2015	—	82	—	—	—	82
Deferred tax credited to the consolidated statement of profit or loss during the year (<i>note 10</i>)	13	175	936	—	—	1,124
At December 31, 2015 and January 1, 2016	13	257	936	—	—	1,206
Deferred tax credited/(charged) to the consolidated statement of profit or loss during the year (<i>note 10</i>)	1	95	(936)	—	—	(840)
At December 31, 2016 and January 1, 2017	14	352	—	—	—	366
Deferred tax (charged)/credited to the consolidated statement of profit or loss during the year (<i>note 10</i>)	(4)	(336)	—	166	486	312
At December 31, 2017	10	16	—	166	486	678

For presentation purposes, certain deferred tax assets and liabilities have been offset in the statement of financial position. The following is an analysis of the deferred tax balances of the Group for financial reporting purposes:

	As at December 31,		
	2015 <i>HK\$'000</i>	2016 <i>HK\$'000</i>	2017 <i>HK\$'000</i>
Net deferred tax liabilities recognised in the consolidated statement of financial position	5,353	5,047	4,682
Net deferred tax assets recognised in the consolidated statement of financial position	(685)	(360)	(678)
	<u>4,668</u>	<u>4,687</u>	<u>4,004</u>

At December 31, 2015, 2016 and 2017, the Group had unrecognised tax losses arising in Hong Kong of HK\$28,166,000, HK\$28,330,000 and HK\$27,290,000, respectively, subject to agreement by relevant tax authorities, that are available indefinitely for offsetting against the future taxable profits of the companies in which the losses arose. At December 31, 2015, 2016 and 2017, the Group also had unrecognised tax losses arising in Mainland China of HK\$11,753,000, HK\$11,972,000 and HK\$4,631,000, subject to agreement by relevant tax authorities, that will expire in five years for offsetting against future taxable profits of the companies in which the loss arose.

Deferred tax assets have not been recognised in respect of these losses as they have arisen in subsidiaries that have been loss-making for some time and it is not considered probable that taxable profits will be available against which the tax losses can be utilised.

Pursuant to the Mainland China Corporate Income Tax Law, a 10% withholding tax is levied on dividends declared to foreign investors from the foreign investment enterprises established in Mainland China. The requirement is effective from January 1, 2008 and applies to earnings after December 31, 2007. A lower withholding tax rate may be applied if there is a tax treaty between Mainland China and the jurisdiction of the foreign investors. For the Group, the applicable rate is 10%. The Group is therefore liable for withholding taxes on dividends distributed by those subsidiaries in Mainland China in respect of earnings generated from January 1, 2008.

At December 31, 2015, 2016 and 2017, no deferred tax has been recognised for withholding taxes that would be payable on unremitted earnings that are subject to withholding taxes of the Group's subsidiaries established in Mainland China. In the opinion of the directors, it is not probable that these subsidiaries will distribute such earnings in the foreseeable future. The aggregate amount of temporary differences associated with investments in subsidiaries in Mainland China for which deferred tax liabilities have not been recognised was approximately HK\$23,016,000, HK\$27,283,000 and HK\$37,277,000 at December 31, 2015, 2016 and 2017, respectively.

There are no income tax consequences attaching to the payment of dividends by the Company to its shareholders.

31. SHARE CAPITAL

	Number of shares	Amount HK\$'000
Authorised:		
At January 1, 2015, December 31, 2015 and December 31, 2016		
— ordinary shares of HK\$0.25 each	400,000,000	100,000
Share split (<i>note b</i>)	600,000,000	—
Increase in authorised share capital (<i>note c</i>)	<u>1,000,000,000</u>	<u>100,000</u>
At December 31, 2017		
— ordinary shares of HK\$0.10 each	<u>2,000,000,000</u>	<u>200,000</u>
Issued and fully paid:		
At January 1, 2015, December 31, 2015 and December 31, 2016		
— ordinary shares of HK\$0.25 each	247,013,281	61,753
Issue of new ordinary shares of HK\$0.25 each (<i>note a</i>)	86,719	22
Share split (<i>note b</i>)	<u>370,650,000</u>	<u>—</u>
At December 31, 2017		
— ordinary shares of HK\$0.10 each	<u>617,750,000</u>	<u>61,775</u>

Note:

- (a) On September 4, 2017, 86,719 ordinary shares of par value HK\$0.25 each were allotted and issued to the sole shareholder for a cash consideration of HK\$21,680, thereby increasing the issued ordinary shares of the Company from 247,013,281 shares to 247,100,000 shares of par value HK\$0.25 each.
- (b) Pursuant to a written resolution of the sole shareholder dated September 4, 2017, every two issued and unissued ordinary shares of par value HK\$0.25 each of the Company were subdivided into five ordinary shares of par value HK\$0.10 each.

- (c) Pursuant to a written resolution of the sole shareholder dated September 4, 2017, the authorised share capital of the Company increased from HK\$100,000,000 divided into 1,000,000,000 shares of par value HK\$0.10 each to HK\$200,000,000 divided into 2,000,000,000 shares of par value HK\$0.10 each, by creation of 1,000,000,000 new shares of par value HK\$0.10 each.

32. RESERVES

Group

The amounts of the Group's reserves and the movements therein for each of the Track Record Period are presented in the consolidated statements of changes in equity on pages I-10 of this report.

(a) Contributed surplus

Pursuant to the written resolutions of the sole shareholder of the Company dated August 25, 2017, the Company reallocated its share premium account to the contributed surplus by way of reduction of the entire amount standing to the credit of the share premium account to nil and transfer of the credit amount arising from the share premium reduction to the contributed surplus.

(b) Statutory reserve funds

Pursuant to the relevant Mainland China rules and regulations, those Mainland China subsidiaries which are domestic enterprises in Mainland China are required to transfer no less than 10% of their profits after taxation, as determined under Mainland China accounting regulations and their respective articles of association, to the reserve funds until the reserve balance reaches 50% of the registered capital. The transfer to this reserve must be made before the dividend distribution to shareholders.

(c) Exchange fluctuation reserve

Exchange fluctuation reserve comprises all foreign currency exchange differences arising from the translation of the financial statements of foreign operations.

APPENDIX I

ACCOUNTANTS' REPORT

(d) Other reserve

The Group's other reserve represents the difference between the amounts by which the non-controlling interests are adjusted and the fair value of the consideration paid to acquire additional interest in a subsidiary.

Company	Note	Share premium reserve HK\$'000	Contributed surplus HK\$'000 (note 32(a))	Retained profits HK\$'000	Total HK\$'000
At January 1, 2015		159,878	—	69,494	229,372
Total comprehensive income for the year		—	—	1,558	1,558
Dividends	12	<u>—</u>	<u>—</u>	<u>(28,147)</u>	<u>(28,147)</u>
At December 31, 2015 and January 1, 2016		159,878	—	42,905	202,783
Total comprehensive income for the year		—	—	4,764	4,764
Dividends	12	<u>—</u>	<u>—</u>	<u>(23,267)</u>	<u>(23,267)</u>
At December 31, 2016 and January 1, 2017		159,878	—	24,402	184,280
Reallocation of share premium		(159,878)	159,878	—	—
Total comprehensive income for the year		—	—	98,113	98,113
Dividends	12	<u>—</u>	<u>(36,300)</u>	<u>(86,645)</u>	<u>(122,945)</u>
At December 31, 2017		<u>—</u>	<u>123,578</u>	<u>35,870</u>	<u>159,448</u>

33. ACQUISITION OF A NON-CONTROLLING INTEREST

On January 10, 2017, the Group acquired a 20% equity interest in TWG Heritage, thereby increasing its ownership interest from 80% to 100%, for a consideration of US\$124,753 (approximately HK\$973,000). TWG Heritage is an investment holding company which owns a 100% equity interest in Dongguan TWG Heritage Food Company Limited, a company established in the PRC primarily involved in the processing of tea products. The carrying amount of the non-controlling interest in TWG Heritage at the date of acquisition was HK\$1,191,000. The Group recognised a decrease in the non-controlling interest of HK\$1,191,000 and an increase in equity attributable to owners of the parent of HK\$218,000.

34. NOTES TO THE CONSOLIDATED STATEMENTS OF CASH FLOWS**(a) Major non-cash transactions**

- (i) During the year ended December 31, 2016, the interest income earned from the ultimate holding company amounting to HK\$489,000 was settled through current account with the ultimate holding company.
- (ii) During the year ended December 31, 2016, the final dividend totalling HK\$10,311,000 was set off against the amount due from the ultimate holding company.

APPENDIX I

ACCOUNTANTS' REPORT

- (iii) During the year ended December 31, 2017, the amount due from related companies amounting to HK\$10,485,000 was settled through current account with the ultimate holding company.
- (iv) During the year ended December 31, 2017, the interest income earned from the ultimate holding company amounting to HK\$419,000 was settled through current account with the ultimate holding company.
- (v) During the year ended December 31, 2017, the interim dividend totalling HK\$86,645,000 was set off against the loans to the ultimate holding company and the amount due from the ultimate holding company.
- (vi) During the year ended December 31, 2017, a special dividend totalling HK\$36,300,000 was declared by the Company and distributed from the contributed surplus, of which HK\$21,800,000 was set off against the amount due from the ultimate holding company and the remaining HK\$14,500,000 was settled in cash.

(b) Reconciliation of liabilities arising from financing activities

The table below details the cash flows and non-cash changes in the Group's liabilities arising from financing activities. Except as disclosed below, there were no non-cash changes in the Group's liabilities arising from financing activities.

	Interest- bearing bank borrowings	Dividend payables	Total
	<i>HK\$'000</i>	<i>HK\$'000</i>	<i>HK\$'000</i>
At January 1, 2015	229,980	—	229,980
Financing cash flows	(55,146)	(28,147)	(83,293)
<i>Non-cash changes</i>			
Dividends declared	—	28,147	28,147
At December 31, 2015 and at January 1, 2016	174,834	—	174,834
Financing cash flows	(701)	(12,956)	(13,657)
<i>Non-cash changes</i>			
Dividends declared	—	23,267	23,267
Settlement of dividend payable through an amount due from the ultimate holding company	—	(10,311)	(10,311)
Effect of changes in foreign exchange rates	(268)	—	(268)
At December 31, 2016 and at January 1, 2017	173,865	—	173,865
Financing cash flows	17,130	(14,500)	2,630
<i>Non-cash changes</i>			
Dividends declared	—	122,945	122,945
Settlement of dividend payables through an amount due from the ultimate holding company	—	(108,445)	(108,445)
Effect of changes in foreign exchange rates	564	—	564
At December 31, 2017	<u>191,559</u>	<u>—</u>	<u>191,559</u>

35. CONTINGENT LIABILITIES

At December 31, 2016 and December 31, 2017, the Group had a contingent liability in respect of a corporate guarantee given to a bank of HK\$212,750,000 in connection with certain banking facilities granted to the ultimate holding company which has not been provided for in the Historical Financial Information. The banking facilities granted to the ultimate holding company were utilised to the extent of HK\$212,750,000.

During the Track Record Period, the Group was not able to obtain the real estate ownership certificate for two warehouses located in the Mainland China (note 14). As the Group completed the construction of the relevant warehouses and commenced usage without obtaining the necessary construction planning permit and construction commencement permit prior to the construction and did not complete the filing of the necessary construction completion reports with the relevant authorities, the Group may be requested by the relevant authorities to demolish the construction and is subject to a maximum penalty amounting to RMB1,321,000 (equivalent to HK\$1,519,000). On December 15, 2017, the Group obtained a temporary construction permit for a period of two years for one of the warehouses ("Warehouse A"). Having considered the recent approval of the temporary construction permit of Warehouse A and the current application status of the temporary construction permit of the remaining warehouse which is currently being processed by the relevant authorities and the advice from the Group's legal counsel, the directors believe that it is not probable that the relevant authorities will impose the penalty. Accordingly, no provision for the relevant liability has been made.

36. OPERATING LEASE COMMITMENTS

The Group leases certain of its warehouses, offices and retail stores under operating lease arrangements. Leases for properties are negotiated for terms ranging from one to four years.

At the end of each of the Track Record Period, the Group had total future minimum lease payments under non-cancellable operating leases falling due as follows:

	As at December 31,		
	2015	2016	2017
	HK\$'000	HK\$'000	HK\$'000
Within one year	9,792	7,472	9,779
In the second to fifth years, inclusive	<u>8,670</u>	<u>5,219</u>	<u>7,719</u>
	<u>18,462</u>	<u>12,691</u>	<u>17,498</u>

37. COMMITMENTS

In addition to the operating lease commitments detailed in note 36 above, the Group had the following capital commitments at the end of each of the Track Record Period:

	As at December 31,		
	2015	2016	2017
	HK\$'000	HK\$'000	HK\$'000
Group			
Contracted, but not provided for in respect of:			
Property, plant and equipment	<u>749</u>	<u>1,285</u>	<u>739</u>

APPENDIX I

ACCOUNTANTS' REPORT

38. RELATED PARTY TRANSACTIONS

- (a) In addition to the transactions, arrangements and balances detailed elsewhere in the Historical Financial Information, the Group had the following material transactions with related parties during the Track Record Period:

	<i>Notes</i>	Year ended December 31,		
		2015 <i>HK\$'000</i>	2016 <i>HK\$'000</i>	2017 <i>HK\$'000</i>
Purchases from a former shareholder and its affiliates	(i)	145,036	19,303	—
Purchases from Guangzhou Dandy Don's Ice-cream Factory Ltd.	(ii)	—	606	920
Rental expenses paid to a related company	(ii)	1,920	1,860	1,860
Interest income earned from the ultimate holding company	(iii)	—	489	419

Notes:

- (i) The former shareholder owned as to approximately 17.2% interest of the Company and also appointed a representative in the board of directors of the Company. In the opinion of the directors, the former shareholder could exercise significant influence over the Group during the period from October 17, 2014 to March 2, 2016.
- (ii) Mr. Wong Tat Tong, a director and the beneficial shareholder of the Company, is the controlling shareholder of these related companies.
- (iii) The interest income earned from the ultimate holding company was based on rates in the range of Hong Kong Interbank Offered Rate ("HIBOR") plus 1.5% per annum for the years ended December 31, 2016 and 2017.

The above transactions were entered into based on terms mutually agreed between the relevant parties.

(b) Compensation of key management personnel of the Group

Remuneration for key management personnel of the Group, including directors' and chief executive's remuneration as disclosed in note 8 to the Historical Financial Information, is as follows:

	Year ended December 31,		
	2015 <i>HK\$'000</i>	2016 <i>HK\$'000</i>	2017 <i>HK\$'000</i>
Short term employee benefits	12,607	14,602	14,264
Pension scheme contributions (defined contribution schemes)	417	441	442
	<u>13,024</u>	<u>15,043</u>	<u>14,706</u>

APPENDIX I

ACCOUNTANTS' REPORT

39. FINANCIAL INSTRUMENTS BY CATEGORY

The carrying amounts of each of the categories of financial instruments as at the end of each of the Track Record Period are as follows:

Financial assets**Group**

December 31, 2015

	Loans and receivables <i>HK\$'000</i>	Available- for-sale financial asset <i>HK\$'000</i>	Total <i>HK\$'000</i>
Available-for-sale investment	—	7,800	7,800
Trade receivables	135,164	—	135,164
Financial assets included in prepayments, deposits and other receivables	7,191	—	7,191
Cash and cash equivalents	<u>59,924</u>	<u>—</u>	<u>59,924</u>
	<u>202,279</u>	<u>7,800</u>	<u>210,079</u>

December 31, 2016

	Financial asset at fair value through profit or loss designated as such upon initial recognition <i>HK\$'000</i>	Loans and receivables <i>HK\$'000</i>	Total <i>HK\$'000</i>
Trade receivables	—	128,923	128,923
Financial assets included in prepayments, deposits and other receivables	—	4,815	4,815
Loans to the ultimate holding company	—	42,849	42,849
Due from the ultimate holding company	—	35,261	35,261
Due from related companies	—	7,214	7,214
Financial investment at fair value through profit or loss	7,781	—	7,781
Cash and cash equivalents	<u>—</u>	<u>48,100</u>	<u>48,100</u>
	<u>7,781</u>	<u>267,162</u>	<u>274,943</u>

APPENDIX I

ACCOUNTANTS' REPORT

December 31, 2017

	Loans and receivables <i>HK\$'000</i>
Trade receivables	170,353
Financial assets included in prepayments, deposits and other receivables	5,576
Cash and cash equivalents	<u>45,613</u>
	<u><u>221,542</u></u>

Company

	Loans and receivables As at December 31,		
	2015 <i>HK\$'000</i>	2016 <i>HK\$'000</i>	2017 <i>HK\$'000</i>
Financial assets included in prepayments and deposits	—	—	1,000
Cash and cash equivalents	<u>7,968</u>	<u>1,478</u>	<u>1,141</u>
	<u><u>7,968</u></u>	<u><u>1,478</u></u>	<u><u>2,141</u></u>

Financial liabilities**Group**

	Financial liabilities at amortised cost As at December 31,		
	2015 <i>HK\$'000</i>	2016 <i>HK\$'000</i>	2017 <i>HK\$'000</i>
Trade and bills payables	74,525	69,743	91,624
Financial liabilities included in accruals and other payables	28,397	27,106	42,452
Interest-bearing bank borrowings	<u>174,834</u>	<u>173,865</u>	<u>191,559</u>
	<u><u>277,756</u></u>	<u><u>270,714</u></u>	<u><u>325,635</u></u>

	Financial liabilities at amortised cost As at December 31,		
	2015 <i>HK\$'000</i>	2016 <i>HK\$'000</i>	2017 <i>HK\$'000</i>
Company			
Financial liabilities included in accruals and other payables	2,065	1,130	10,583
Due to a subsidiary	<u>13</u>	<u>13</u>	<u>—</u>
	<u><u>2,078</u></u>	<u><u>1,143</u></u>	<u><u>10,583</u></u>

40. FAIR VALUE AND FAIR VALUE HIERARCHY OF FINANCIAL INSTRUMENTS

Management has assessed that the fair values of cash and cash equivalents, trade receivables, current portion of financial assets included in prepayments, deposits and other receivables, loans to the ultimate holding company, amounts due from the ultimate holding company and related companies, trade and bills payables, financial liabilities included in accruals and other payables, current portion of interest-bearing bank borrowings approximate to their carrying amounts largely due to the short term maturities of these instruments or the effect of discounting is not material.

The fair values of the financial assets and liabilities are included at the amount at which the instrument could be exchanged in a current transaction between willing parties, other than in a forced or liquidation sale. The following methods and assumptions were used to estimate the fair values:

The fair values of the non-current portion of deposits have been calculated by discounting the expected future cash flows using the rates currently available for instruments with similar terms, credit risk and remaining maturities.

The carrying value of the non-current portion of the variable rate interest-bearing bank borrowings is assumed to be their fair value based on frequent repricing.

The Group entered into a structured deposit which is classified as financial investment at fair value through profit or loss with a creditworthy bank with no recent history of default. The fair value of the structured deposit is determined based on broker price quotations. The carrying amount of the structured deposit is the same as its fair value.

Fair value hierarchy

The following tables illustrate the fair value measurement hierarchy of the Group's financial instruments:

Assets measured at fair value:

	As at December 31,		
	2015	2016	2017
	<i>HK\$'000</i>	<i>HK\$'000</i>	<i>HK\$'000</i>
Fair value measurement using significant observable inputs (Level 2)			
Financial investment at fair value through profit or loss	—	7,781	—

The Group did not have any financial assets measured at fair value as at December 31, 2015 and 2017 or any financial liabilities measured at fair value as at the end of each of the Track Record Period.

During the Track Record Period, there were no transfers of fair value measurements between Level 1 and Level 2 and no transfers into or out of Level 3 for both financial assets and financial liabilities.

41. FINANCIAL RISK MANAGEMENT OBJECTIVES AND POLICIES

The Group's principal financial instruments include financial investment at fair value through profit or loss, cash and cash equivalents and interest-bearing bank borrowings. The main purpose of these financial instruments is to finance the Group's operations.

The main risks arising from the Group's financial instruments are interest rate risk, foreign currency risk, credit risk and liquidity risk. The board of directors reviews and agrees policies for managing each of these risks and they are summarised below.

Interest rate risk

Interest rate risk is the risk that the future cash flows of a financial instrument will fluctuate because of changes in market interest rates. The Group's exposure to the risk of changes in market interest rates relates primarily to the Group's interest-bearing bank borrowings with floating interest rates. Management monitors interest rate exposure and will consider hedging significant interest rate risk should the need arise.

The following table demonstrates the sensitivity to a reasonably possible change in interest rates, with all other variables held constant, of the Group's profit before tax from continuing operations (through the impact on floating rate bank borrowings).

	Increase/ (decrease) in basis points	Increase/ (decrease) in profit before tax <i>HK\$'000</i>
December 31, 2015		
HK\$	50	(564)
HK\$	(50)	564
RMB	50	91
RMB	<u>(50)</u>	<u>(91)</u>
December 31, 2016		
HK\$	50	(372)
HK\$	(50)	372
RMB	50	97
RMB	<u>(50)</u>	<u>(97)</u>
December 31, 2017		
HK\$	50	(636)
HK\$	(50)	636
RMB	50	7
RMB	<u>(50)</u>	<u>(7)</u>

Foreign currency risk

The Group has transactional currency exposures. Such exposures mainly arise from sales or purchases by operating units in currencies other than the unit's functional currencies. The majority of the Group's foreign currency purchase transactions are denominated in US\$. On the other hand, the sales and disbursements are mainly denominated in HK\$ and RMB. As HK\$ is pegged to US\$, the Company does not anticipate significant movements in the US\$/HK\$ exchange rates and the exposure on foreign currency risk is not material.

The Group's risk management principle with regard to its foreign currency denominated monetary assets, liabilities, commitments, and cash flows is to match as far as possible the values of such assets and cash flows against similarly denominated liabilities and cash flows. Decisions on either holding net short or long positions in foreign currency denominated monetary assets or liabilities are taken on a case-by-case basis and by taking into consideration the amount and duration of the expenses, market volatility, economic trends and requirements of the business.

APPENDIX I

ACCOUNTANTS' REPORT

The following table demonstrates the sensitivity at the end of the reporting period to a reasonably possible change in the Euro and RMB exchange rates, with all other variables held constant, of the Group's profit before tax.

	Increase/ (decrease) in exchange rate	Increase/ (decrease) in profit before tax <i>HK\$'000</i>
December 31, 2015		
If HK\$ weakens against Euro	5%	(130)
If HK\$ strengthens against Euro	(5%)	130
If HK\$ weakens against RMB	5%	1
If HK\$ strengthens against RMB	(5%)	<u>(1)</u>
December 31, 2016		
If HK\$ weakens against Euro	5%	(77)
If HK\$ strengthens against Euro	(5%)	77
If HK\$ weakens against RMB	5%	150
If HK\$ strengthens against RMB	(5%)	<u>(150)</u>
December 31, 2017		
If HK\$ weakens against Euro	5%	(223)
If HK\$ strengthens against Euro	(5%)	223
If HK\$ weakens against RMB	5%	(135)
If HK\$ strengthens against RMB	(5%)	<u>135</u>

Credit risk

The Group trades only with recognised and creditworthy third parties. It is the Group's policy that all customers who wish to trade on credit terms are subject to credit verification procedures. In addition, receivable balances are monitored on an ongoing basis and the Group's exposure to bad debts is not significant.

The credit risk of the Group's other financial assets, which comprise cash and cash equivalents, financial investment at fair value through profit or loss, financial assets included in prepayments, deposits and other receivables, loans to and amounts due from the ultimate holding company and related companies arises from default of the counterparty, with a maximum exposure equal to the carrying amounts of these instruments.

Since the Group trades only with recognised and creditworthy third parties, there is no requirement for collateral. Concentrations of credit risk are managed by customer/counterparty, by geographical region and by industry segment. At the end of each of the Track Record Period, the Group had certain concentrations of credit risk as 8%, 4% and 6%, and 26%, 25% and 29% of the Group's trade receivables as at December 31, 2015, 2016 and 2017 were due from the Group's largest debtor and the five largest debtors, respectively.

Further quantitative data in respect of the Group's exposure to credit risk arising from trade receivables are disclosed in note 22 to the Historical Financial Information.

APPENDIX I

ACCOUNTANTS' REPORT

Liquidity risk

The Group's objective is to ensure there are adequate funds to meet its liquidity requirements in the short and longer terms. In the management of liquidity risk, the Group has been maintaining a cash pooling system where excess liquidity is equalised internally through inter-group accounts. Depending on the specific requirements of each funding agreement, funding for the Group's operating companies may be sourced directly from the Group's bankers or indirectly through the Company.

The following tables show the maturity profile of the Group's financial liabilities as at the end of each of the Track Record Period, based on the contractual undiscounted payments.

	On demand/ within 3 months HK\$'000	Less than 1 year HK\$'000	Within 2 to 5 years HK\$'000	Total HK\$'000
December 31, 2015				
Trade and bills payables	74,525	—	—	74,525
Financial liabilities included in accruals and other payables	28,397	—	—	28,397
Interest-bearing bank borrowings	<u>81,827</u>	<u>36,130</u>	<u>61,417</u>	<u>179,374</u>
	<u>184,749</u>	<u>36,130</u>	<u>61,417</u>	<u>282,296</u>
	On demand/ within 3 months HK\$'000	Less than 1 year HK\$'000	Within 2 to 5 years HK\$'000	Total HK\$'000
December 31, 2016				
Trade and bills payables	69,743	—	—	69,743
Financial liabilities included in accruals and other payables	27,106	—	—	27,106
Interest-bearing bank borrowings	92,516	40,322	44,420	177,258
Guarantees given to a bank in connection with facilities granted to the ultimate holding company	<u>212,750</u>	<u>—</u>	<u>—</u>	<u>212,750</u>
	<u>402,115</u>	<u>40,322</u>	<u>44,420</u>	<u>486,857</u>
December 31, 2017				
Trade and bills payables	91,624	—	—	91,624
Financial liabilities included in accruals and other payables	42,452	—	—	42,452
Interest-bearing bank borrowings	122,245	18,405	55,682	196,332
Guarantees given to a bank in connection with facilities granted to the ultimate holding company	<u>212,750</u>	<u>—</u>	<u>—</u>	<u>212,750</u>
	<u>469,071</u>	<u>18,405</u>	<u>55,682</u>	<u>543,158</u>

Capital management

The primary objectives of the Group's capital management are to safeguard the Group's ability to continue as a going concern and to maintain healthy capital ratios in order to support its business and maximise shareholder's value.

The Group manages its capital structure and makes adjustments to it in light of changes in economic conditions and the risk characteristics of the underlying assets. To maintain or adjust the capital structure, the Group may adjust the dividend payment to the shareholder, return capital to shareholder or issue new shares. The Group is required to comply with certain externally imposed capital requirements as set out in certain banking facility letters. No changes were made in the objectives, policies or processes for managing capital during the Track Record Period.

The Group monitors capital using a gearing ratio, which is the ratio of interest-bearing bank borrowings to total shareholders' equity. Total shareholders' equity comprises all components of equity attributable to owners of the Company. The Group's policy is to maintain the gearing ratio at a reasonable level. The gearing ratios as at the end of the reporting periods were as follows:

	As at December 31,		
	2015 HK\$'000	2016 HK\$'000	2017 HK\$'000
Interest-bearing bank borrowings	<u>174,834</u>	<u>173,865</u>	<u>191,559</u>
Total equity attributable to owners of the parent	<u>247,366</u>	<u>279,253</u>	<u>214,169</u>
Gearing ratio	<u>70.7%</u>	<u>62.3%</u>	<u>89.4%</u>

42. PARTLY-OWNED SUBSIDIARY WITH MATERIAL NON-CONTROLLING INTERESTS

Details of the Group's subsidiary that has material non-controlling interests are set out below:

	As at December 31,		
	2015	2016	2017
Percentage of equity interest held by non-controlling interests:			
Whole Sun Limited	<u>40%</u>	<u>40%</u>	<u>40%</u>

	Year ended December 31,		
	2015 HK\$'000	2016 HK\$'000	2017 HK\$'000
(Loss)/profit for the year allocated to non-controlling interests:			
Whole Sun Limited	<u>(945)</u>	<u>1,402</u>	<u>2,279</u>

	As at December 31,		
	2015 HK\$'000	2016 HK\$'000	2017 HK\$'000
Accumulated balances of non-controlling interests at reporting dates:			
Whole Sun Limited	<u>15,452</u>	<u>16,854</u>	<u>17,891</u>

APPENDIX I

ACCOUNTANTS' REPORT

The following tables illustrate the summarised financial information of Whole Sun Limited. The amounts disclosed are before any inter-company eliminations:

	Year ended December 31,		
	2015	2016	2017
	HK\$'000	HK\$'000	HK\$'000
Revenue	193,005	198,235	226,451
Total expenses, other gains and losses, net	(195,368)	(194,731)	(220,754)
(Loss)/profit for the year and			
total comprehensive (loss)/income for the year	(2,363)	3,504	5,697
Dividends	—	—	(3,105)

	Year ended December 31,		
	2015	2016	2017
	HK\$'000	HK\$'000	HK\$'000
Net cash flows from/(used in) operating activities	14,440	22,419	(1,234)
Net cash flows from/(used in) investing activities	493	(22)	(12)
Net cash flows (used in)/from financing activities	(13,835)	(19,188)	1,831
Net increase in cash and cash equivalents	1,098	3,209	585

	As at December 31,		
	2015	2016	2017
	HK\$'000	HK\$'000	HK\$'000
Current assets	102,533	83,016	102,170
Non-current assets	8,407	6,403	4,386
Current liabilities	(71,263)	(46,231)	(61,115)
Non-current liabilities	(1,047)	(1,054)	(715)

43. EVENTS AFTER THE TRACK RECORD PERIOD

A final dividend of HK\$10,000,000 for the year ended December 31, 2017 and an interim dividend of HK\$8,093,000 for the year ending December 31, 2018 were declared and approved on January 23, 2018 and April 19, 2018, respectively.

On April 19, 2018, the Company granted 9,000,000 share options to certain directors of the Company and certain employees of the Group.

44. SUBSEQUENT FINANCIAL STATEMENTS

No audited financial statements have been prepared by the Group or any of its subsidiaries in respect of any period subsequent to December 31, 2017.

APPENDIX II UNAUDITED PRO FORMA FINANCIAL INFORMATION

The following information sets out in this appendix does not form part of the Accountants' Report from Ernst & Young, Certified Public Accountants, Hong Kong, the Company's Reporting Accountants, as set out in Appendix I to this prospectus, and is included herein for illustrative purpose only. The unaudited pro forma financial information should be read in conjunction with "Financial Information" and the Accountants' Report set out in Appendix I to this prospectus.

A. UNAUDITED PRO FORMA STATEMENT OF ADJUSTED CONSOLIDATED NET TANGIBLE ASSETS

The following is an illustrative statement of unaudited pro forma adjusted consolidated net tangible assets of the Group prepared in accordance with paragraph 4.29 of the Rules Governing the Listing of Securities on The Stock Exchange of Hong Kong Limited and on the basis of the notes set out below for the purpose of illustrating the effect of the Global Offering on the consolidated net tangible assets of the Group attributable to owners of the parent as if the Global Offering had taken place on December 31, 2017. This unaudited pro forma statement of adjusted consolidated net tangible assets of the Group has been prepared for illustrative purposes only and, because of its hypothetical nature, it may not give a true picture of the consolidated net tangible assets of the Group had the Global Offering been completed as at December 31, 2017 or any future dates:

	Consolidated net tangible assets attributable to owners of the parent as at December 31, 2017 HK\$'000 (Note 1)	Estimated net proceeds from the Global Offering HK\$'000 (Note 2)	Unaudited pro forma adjusted consolidated net tangible assets HK\$'000	Unaudited pro forma adjusted consolidated net tangible assets per Share HK\$ (Note 3 and 4)
Based on the Offer Price of HK\$1.50 per Share	193,702	143,735	337,437	0.47
Based on the Offer Price of HK\$2.19 per Share	193,702	214,248	407,950	0.56

Notes:

- (1) The consolidated net tangible assets attributable to owners of the parent as at December 31, 2017 is extracted from the Accountants' Report set out in Appendix I to this prospectus, which is based on the audited consolidated equity attributable to owners of the parent as at December 31, 2017 of HK\$214,169,000 with adjustments for goodwill of HK\$15,447,000 and intangible assets of HK\$5,020,000.
- (2) The estimated net proceeds from the Global Offering are based on the Offer Price of HK\$1.50 and HK\$2.19 per Offer Share, after deduction of the underwriting fees and other listing related expenses expected to be incurred subsequent to December 31, 2017, and without taking into account of any Shares which may be issued upon exercise of Over-allotment Option or any options which have been or may be granted under the Pre-IPO Share Option Scheme and Share Option Scheme.

APPENDIX II UNAUDITED PRO FORMA FINANCIAL INFORMATION

- (3) The unaudited pro forma adjusted consolidated net tangible assets per Share is calculated based on 723,979,312 Shares expected to be in issue immediately following the completion of the Global Offering without taking into account of any Shares which may be issued upon exercise of the Over-allotment Option or of any options which have been or may be granted under the Pre-IPO Share Option Scheme and the Share Option Scheme.
- (4) The unaudited pro forma adjusted consolidated net tangible assets attributable to owners of the parent does not take into account a final dividend of HK\$10,000,000 for the year ended December 31, 2017 and an interim dividend of HK\$8,093,000 for the year ending December 31, 2018 declared on January 23, 2018 and April 19, 2018, respectively. Had the dividend been taken into account, the unaudited pro forma adjusted consolidated net tangible assets of the Group per Share would have been HK\$0.44 and HK\$0.54 at the Offer Price of HK\$1.50 and HK\$2.19, respectively, which is calculated based on 723,979,312 Shares expected to be in issue immediately following the completion of the Global Offering without taking into account of any Shares which may be issued upon exercise of the Over-allotment Option or of any options which have been or may be granted under the Pre-IPO Share Option Scheme and the Share Option Scheme.

APPENDIX II UNAUDITED PRO FORMA FINANCIAL INFORMATION

B. REPORT ON THE UNAUDITED PRO FORMA FINANCIAL INFORMATION

The following is the text of a report, prepared for the purpose of incorporation in this prospectus, received from the Company's Reporting Accountants, Ernst & Young, Certified Public Accountants, Hong Kong.



22/F CITIC Tower
1 Tim Mei Avenue
Central, Hong Kong

To the Directors of Tsit Wing International Holdings Limited

We have completed our assurance engagement to report on the compilation of pro forma financial information of Tsit Wing International Holdings Limited (the “Company”) and its subsidiaries (hereinafter collectively referred to as the “Group”) by the directors of the Company (the “Directors”) for illustrative purposes only. The pro forma financial information consists of the pro forma consolidated net tangible assets as at December 31, 2017 and related notes as set out on pages II-1 and II-2 of the prospectus dated April 30, 2018 issued by the Company (the “Pro Forma Financial Information”). The applicable criteria on the basis of which the Directors have compiled the Pro Forma Financial Information are described in notes as set out on pages II-1 and II-2 of the prospectus.

The Pro Forma Financial Information has been compiled by the Directors to illustrate the impact of the global offering of shares of the Company on the Group’s financial position as at December 31, 2017. As part of this process, information about the Group’s financial position has been extracted by the Directors from the Group’s financial statements for the period ended December 31, 2017, on which an accountants’ report has been published.

DIRECTORS’ RESPONSIBILITY FOR THE PRO FORMA FINANCIAL INFORMATION

The Directors are responsible for compiling the Pro Forma Financial Information in accordance with paragraph 4.29 of the Rules Governing the Listing of Securities on The Stock Exchange of Hong Kong Limited (the “Listing Rules”) and with reference to Accounting Guideline (“AG”) 7 *Preparation of Pro Forma Financial Information for Inclusion in Investment Circulars* issued by the Hong Kong Institute of Certified Public Accountants (the “HKICPA”).

OUR INDEPENDENCE AND QUALITY CONTROL

We have complied with the independence and other ethical requirements of the *Code of Ethics for Professional Accountants* issued by the HKICPA, which is founded on fundamental principles of integrity, objectivity, professional competence and due care, confidentiality and professional behavior.

APPENDIX II UNAUDITED PRO FORMA FINANCIAL INFORMATION

Our firm applies Hong Kong Standard on Quality Control 1 *Quality Control for Firms that Perform Audits and Reviews of Financial Statements, and Other Assurance and Related Services Engagements*, and accordingly maintains a comprehensive system of quality control including documented policies and procedures regarding compliance with ethical requirements, professional standards and applicable legal and regulatory requirements.

REPORTING ACCOUNTANTS' RESPONSIBILITIES

Our responsibility is to express an opinion, as required by paragraph 4.29(7) of the Listing Rules, on the Pro Forma Financial Information and to report our opinion to you. We do not accept any responsibility for any reports previously given by us on any financial information used in the compilation of the Pro Forma Financial Information beyond that owed to those to whom those reports were addressed by us at the dates of their issue.

We conducted our engagement in accordance with Hong Kong Standard on Assurance Engagements 3420 *Assurance Engagements to Report on the Compilation of Pro Forma Financial Information Included in a Prospectus* issued by the HKICPA. This standard requires that the reporting accountants plan and perform procedures to obtain reasonable assurance about whether the Directors have compiled the Pro Forma Financial Information in accordance with paragraph 4.29 of the Listing Rules and with reference to AG 7 issued by the HKICPA.

For purposes of this engagement, we are not responsible for updating or reissuing any reports or opinions on any historical financial information used in compiling the Pro Forma Financial Information, nor have we, in the course of this engagement, performed an audit or review of the financial information used in compiling the Pro Forma Financial Information.

The purpose of the Pro Forma Financial Information included in the Prospectus is solely to illustrate the impact of the global offering of shares of the Company on unadjusted financial information of the Group as if the transaction had been undertaken at an earlier date selected for purposes of the illustration. Accordingly, we do not provide any assurance that the actual outcome of the transaction would have been as presented.

A reasonable assurance engagement to report on whether the Pro Forma Financial Information has been properly compiled on the basis of the applicable criteria involves performing procedures to assess whether the applicable criteria used by the Directors in the compilation of the Pro Forma Financial Information provide a reasonable basis for presenting the significant effects directly attributable to the transaction, and to obtain sufficient appropriate evidence about whether:

- the related pro forma adjustments give appropriate effect to those criteria; and
- the Pro Forma Financial Information reflects the proper application of those adjustments to the unadjusted financial information.

APPENDIX II UNAUDITED PRO FORMA FINANCIAL INFORMATION

The procedures selected depend on the reporting accountants' judgment, having regard to the reporting accountants' understanding of the nature of the Group, the transaction in respect of which the Pro Forma Financial Information has been compiled, and other relevant engagement circumstances.

The engagement also involves evaluating the overall presentation of the Pro Forma Financial Information.

We believe that the evidence we have obtained is sufficient and appropriate to provide a basis for our opinion.

OPINION

In our opinion:

- (a) the Pro Forma Financial Information has been properly compiled on the basis stated;
- (b) such basis is consistent with the accounting policies of the Group; and
- (c) the adjustments are appropriate for the purpose of the Pro Forma Financial Information as disclosed pursuant to paragraph 4.29(1) of the Listing Rules.

Yours faithfully,

Ernst & Young
Certified Public Accountants
Hong Kong

April 30, 2018

APPENDIX III

SUMMARY OF THE CONSTITUTION OF
OUR COMPANY AND BERMUDA COMPANY LAW

Set out below is a summary of certain provisions of the Memorandum of Association and Bye-laws of our Company and of certain aspects of Bermuda company law.

Our Company was incorporated in Bermuda as an exempted company with limited liability on June 13, 2000 under the Companies Act. Our Company's constitutional documents consist of its Memorandum of Association and its Bye-Laws.

1. MEMORANDUM OF ASSOCIATION

The Memorandum states, *inter alia*, that the liability of the members of our Company is limited to the amount, if any, for the time being unpaid on the Shares respectively held by the shareholders and that our Company is an exempted company as defined in the Companies Act. The Memorandum also sets out the powers of our Company and the objects for which our Company was formed. As an exempted company, our Company will be carrying on business outside Bermuda from a place of business in Bermuda.

In accordance with and subject to the Companies Act, the Memorandum of our Company empowers it to purchase its own shares; and pursuant to the Bye-Laws, this power is exercisable by the Board upon such terms and subject to such conditions as it thinks fit.

2. BYE-LAWS

The Bye-laws of our Company were conditionally adopted on December 15, 2017 and effective from the Listing Date. A summary of certain provisions of the Bye-laws is set out below.

(a) Shares**(i) Classes of shares**

The share capital of our Company consists of ordinary shares.

(ii) Share certificates

Every certificate for shares, warrants or debentures or representing any other form of securities of our Company shall be issued under the seal of our Company, which for this purpose may be a securities seal. No signature of any Director, officer or other person and no mechanical reproduction of any such signature shall be required on any certificates for shares or other securities of our Company or other document and any such certificates or other document to which such securities seal is affixed shall be valid and deemed to have been sealed and executed with the authority of the Board notwithstanding the absence of any such signature. The Board may by resolution determine that the affixation of the securities seal on certificates for shares or other securities issued by our Company be dispensed with or be affixed by printing the image of the securities seal on such certificates.

Our Company shall not be bound to register more than four persons as joint holders of any share.

(iii) Variation of rights of existing shares or classes of shares

If at any time the capital is divided into different classes of shares, all or any of the special rights (unless otherwise provided for by the terms of issue of that class) attached to any class may, subject to the provisions of the Companies Act, be varied or abrogated either with the consent in writing of the holders of not less than three-fourths in nominal value of the issued shares of that class or with the sanction of a special resolution passed at a separate general meeting of the holders of the shares of that class. The provisions of the Bye-laws relating to general meetings will apply mutatis mutandis to every such separate general meeting, but so that the necessary quorum is not less than two persons holding or representing by proxy one-third in nominal value of the issued shares of the class, and that any holder of shares of the class present in person or by proxy or by a duly authorized corporate representative may demand a poll.

(iv) Alterations of capital

Our Company may from time to time by ordinary resolution: (i) increase its share capital by the creation of new shares; (ii) consolidate all or any of its share capital into shares of larger amount than its existing shares; (iii) divide its shares into several classes and attach to such shares any preferential, deferred, qualified or special rights, privileges or conditions; (iv) sub-divide its shares or any of them into shares of smaller amount than is fixed by the Memorandum; (v) cancel any shares which at the date of the resolution have not been taken or agreed to be taken by any person, and diminish the amount of its share capital by the amount of the shares so cancelled; (vi) make provision for the issue and allotment of shares which do not carry any voting rights; and (vii) change the currency denomination of its share capital.

Our Company may by special resolution reduce its share capital, any capital redemption reserve fund or any share premium account in any manner authorized and subject to any conditions prescribed by law.

(v) Transfer of shares

All transfers of shares must be effected by transfer in writing in the usual or common form or in any other form acceptable to the Board and may be under hand or by means of mechanically imprinted signatures or such other manner as the Board may from time to time approve. An instrument of transfer must be executed by or on behalf of the transferor and by or on behalf of the transferee and the transferor shall be deemed to remain the holder of a share until the name of the transferee is entered in the register of members in respect of that share.

The Board may, in its absolute discretion, at any time and from time to time transfer any share on the principal register to any branch register or any share on any branch register to the principal register or any other branch register. Unless the Board otherwise agrees, no shares on the principal register shall be transferred to any branch register nor shall shares on any branch register be transferred to the principal register or any other register. All transfers and other documents of title must be lodged for registration and registered, in the case of shares on a branch register, at the relevant registration office and, in the case of shares on the principal register, at the transfer office in Bermuda.

The Board may in its absolute discretion and without assigning any reason, refuse to register a transfer of any shares (not being fully paid shares) to a person of whom it does not approve or on which our Company has a lien. The Board may also refuse to register a transfer of shares (whether fully paid or not) in favour of more than four persons jointly. If the Board refuses to register a transfer, it will within two months after the date on which the transfer was lodged with our Company send to the transferor and the transferee the notice of the refusal.

The Board may decline to recognise any instrument of transfer unless the specified fee of up to such sum as the applicable stock exchange may determine to be payable is paid to our Company, the shares are free of any lien in favour of our Company, the instrument of transfer is properly stamped, is in respect of only one class of share and is lodged at the relevant registration or transfer office accompanied by the relevant share certificate(s) and such other evidence as the Board may reasonably require is provided to show the right of the transferor to make the transfer (and if the instrument of transfer is executed by some other person on his behalf, the authority of that person so to do). Where applicable, the permission of the Bermuda Monetary Authority with respect to the transfer shall be obtained.

The registration of transfers may be suspended and the register may be closed at such times and for such periods as the Board may from time to time determine and either generally or in respect of any class of shares. The register of members shall not be closed for more than 30 days in any year.

Fully paid shares shall be free from any restriction on transfer (except when permitted by the Hong Kong Stock Exchange) and shall also be free from all liens.

(vi) Power for our Company to purchase its own shares

Our Company's power to repurchase its own shares is exercisable by the Board, upon such terms and subject to such conditions as it thinks fit.

(vii) Power of any subsidiary of our Company to own shares in our Company

There are no provisions in the Bye-laws relating to ownership of shares in our Company by a subsidiary.

(viii) Calls on shares and forfeiture of shares

The Board may from time to time make such calls as it thinks fit upon the shareholders in respect of any monies unpaid on the shares held by them (whether on account of the nominal value of the shares or by way of premium) and not by the conditions of allotment of such shares made payable at fixed times. A call may be made payable either in one sum or by instalments. If the sum payable in respect of any call or instalment is not paid on or before the day appointed for payment, the person or persons from whom the sum is due shall pay interest on the same at such rate not exceeding 20% per annum as the Board shall fix from the day appointed for payment to the time of actual payment, but the Board may waive payment of such interest wholly or in part. The Board may, if it thinks fit, receive from any shareholder willing to advance the same, either in money or money's worth, all or any part of the money uncalled and unpaid or instalments payable upon any shares held by him, and upon all or any of the monies so advanced our Company may pay interest at such rate (if any) not exceeding 20% per annum as the Board may decide.

If a shareholder fails to pay any call or instalment of a call on the day appointed for payment, the Board may, for so long as any part of the call or instalment remains unpaid, serve a notice on the shareholder requiring payment of so much of the call or instalment as is unpaid, together with any interest which may have accrued and which may still accrue up to the date of actual payment. The notice shall name a further day (not earlier than the expiration of 14 days from the date of the notice) on or before which the payment required by the notice is to be made, and shall also name the place where payment is to be made. The notice shall also state that, in the event of non-payment at or before the appointed time, the shares in respect of which the call was made will be liable to be forfeited.

If the requirements of any such notice are not complied with, any share in respect of which the notice has been given may at any time thereafter, before the payment required by the notice has been made, be forfeited by a resolution of the Board to that effect. Such forfeiture will include all dividends and bonuses declared in respect of the forfeited share and not actually paid before the forfeiture.

A person whose shares have been forfeited shall cease to be a shareholder in respect of the forfeited shares but shall, nevertheless, remain liable to pay to our Company all moneys which, at the date of forfeiture, were payable by him to our Company in respect of the shares together with (if the Board shall in its discretion so require) interest thereon from the date of forfeiture until payment at such rate not exceeding 20% per annum as the Board may prescribe.

(b) Directors***(i) Appointment, retirement and removal***

At each annual general meeting one-third of the Directors for the time being, or if their number is not three or a multiple of three then the number nearest to but not less than one third, shall retire from office by rotation. The Directors to retire in every year shall be those who have been in office longest since their last election but, as between persons who became Directors on the same day, those to retire shall (unless they otherwise agree between themselves) be determined by lot.

No person, other than a retiring Director, shall, unless recommended by the Board for election, be eligible for election to the office of Director at any general meeting, unless a notice in writing of the intention to propose that person for election as a Director and notice in writing by that person of his willingness to be elected have been lodged at the head office or at the registration office of our Company at least seven days before the date of the general meeting.

The number of Directors shall not be less than two. A Director may be removed by an ordinary resolution of our Company before the expiration of his period of office (but without prejudice to any claim which such Director may have for damages for breach of any contract of service between him and our Company). Our Company may from time to time in general meeting by ordinary resolution elect any person to be a Director either to fill a casual vacancy or as an addition to the Board.

There is no shareholding qualification for Directors nor is there any specified age limit for Directors.

The Board may from time to time entrust to and confer upon a managing director, joint managing director, deputy managing director or executive director all or any of the powers of the Board that it thinks fit provided that the exercise of all powers by such director shall be subject to such regulations and restrictions as the Board may from time to time make and impose. The Board may delegate any of its powers to committees consisting of such member or members of its body and such other persons as the Board thinks fit, and it may from time to time revoke such delegation or revoke the appointment of and discharge any such committees either wholly or in part, and either as to persons or purposes, but every committee so formed shall in the exercise of the powers so delegated conform to any regulations that may from time to time be imposed upon it by the Board.

(ii) Power to allot and issue shares

Without prejudice to any special rights or restrictions for the time being attaching to any shares or any class of shares, any share may be issued upon such terms and conditions and with such preferred, deferred or other special rights, or such restrictions, whether as regards dividend, voting, return of capital or

otherwise, as our Company may from time to time by ordinary resolution determine (or, in the absence of any such determination or so far as the same may not make specific provision, as the Board may determine). Any preference share may, subject to the Companies Act and with the sanction of a special resolution, be issued on terms that it is liable to be redeemed upon the happening of a specified event or upon a given date and either at the option of our Company or, if so authorized by the Memorandum, at the option of the holder.

The Board may, subject to the approval by the shareholders in general meeting, issue warrants to subscribe for any class of shares or securities of our Company on such terms as the Board may from time to time determine. Where warrants are issued to bearer, no certificate in respect of such warrants shall be issued to replace one that has been lost unless the Board is satisfied beyond reasonable doubt that the original certificate has been destroyed and our Company has received an indemnity in such form as the Board thinks fit with regard to the issue of any such replacement certificate.

All unissued shares in our Company shall be at the disposal of the Board, which may offer, allot, grant options over or otherwise dispose of them to such persons, at such times, for such consideration and generally on such terms as it shall in its absolute discretion think fit, but so that no shares shall be issued at a discount.

(iii) Power to dispose of the assets of our Company or any of its subsidiaries

While there are no specific provisions in the Bye-laws relating to the disposal of the assets of our Company or any of its subsidiaries, the Board may exercise all powers and do all acts and things which may be exercised or done or approved by our Company and which are not required by the Bye-laws or the statutes to be exercised or done by our Company in general meeting.

(iv) Borrowing powers

Subject to the provisions of the Companies Act, the Board may from time to time at its discretion exercise all the powers of our Company to raise or borrow or to secure the payment of any sum or sums of money for the purposes of our Company and to mortgage or charge its undertaking, property and uncalled capital or any part thereof. The Board may raise or secure the payment or repayment of such sum or sums in such manner and upon such terms and conditions in all respects as it thinks fit and in particular by the issue of debentures, debenture stock, bonds or other securities of our Company, whether outright or as collateral security for any debt, liability or obligation of our Company or of any third party.

(v) Remuneration

The Directors shall be entitled to receive by way of remuneration for their services such sum as is from time to time determined by our Company in general meeting, such sum (unless otherwise directed by the resolution by which it is determined) to be divided among the Directors in such proportions and in such manner as the Board may agree or, failing agreement, equally or, in the case of any Director holding office for less than the whole of the relevant period in respect of which the remuneration is paid, pro rata. These provisions shall not apply to a Director who holds any salaried employment or office in our Company except in the case of sums paid in respect of Directors' fees. The Directors shall also be entitled to be repaid all expenses reasonably incurred by them in the performance of their duties as Directors or otherwise incurred whilst engaged on the business of our Company. The Board may grant special remuneration to any Director who performs any special or extra services to or at the request of our Company. Such special remuneration may be made payable to such Director in addition to or in substitution for his ordinary remuneration as a Director. The remuneration of managing director, joint managing director, deputy managing director or other executive director or a director appointed to any other office in the management of our Company may be fixed from time to time by the Board and may comprise remuneration and such other benefits and allowances as the Board may from time to time decide. Such remuneration is in addition to his remuneration as a Director.

The Board also has power to establish and maintain or procure the establishment and maintenance of any contributory or non-contributory pension or superannuation funds for the benefit of, or to give or procure the giving of donations, gratuities, pensions, allowances or emoluments to, any persons who are or were at any time in the employment or service of our Company, or of any company which is a subsidiary of our Company or is allied or associated with our Company or with any such subsidiary, or who are or were at any time Directors or officers of our Company or of any such other company and who hold or have held any salaried employment or office in our Company or such other company, and the dependents of any such persons, and may make payments for or towards the insurance of any such persons. Any Director holding any such employment or office is entitled to participate in and retain for his own benefit any such donation, gratuity, pension, allowance or emolument.

(vi) Compensation or payments for loss of office

Payments to any Director or past Director of any sum by way of compensation for loss of office or as consideration for or in connection with his retirement from office (not being a payment to which the Director is contractually entitled) must be approved by our Company in general meeting.

(vii) Loans to Directors

There are no provisions in the Bye-laws relating to the making of loans to Directors. However, the Companies Act contains restrictions on companies making loans to their directors, the relevant provisions of which are summarised in section 3(n) of this Appendix.

(viii) Financial assistance to acquire shares in our Company

- (aa) Subject, where applicable, to the rules of any relevant stock exchange:
- (x) our Company may in accordance with an employees' share scheme (as defined in the Companies Act) approved by the shareholders in general meeting provide money on such terms as the Board thinks fit for the acquisition of fully or partly paid shares in our Company or its holding company; and
 - (y) our Company, our Company's subsidiary or holding company or a subsidiary of our Company's holding company may make loans to persons, including Directors and former Directors, employed in good faith by our Company with a view to enabling those persons, to acquire fully or partly paid shares in our Company or its holding company to be held by them by way of beneficial ownership.
- (bb) The conditions subject to which money and loans are provided may include a provision to the effect that when an employee ceases to be employed by our Company, the shares acquired with such financial assistance shall or may be sold to our Company or such other company on such terms as the Board thinks fit.

(ix) Disclosure of interests in contracts with our Company or any of its subsidiaries

Subject to the Companies Act, a Director may hold any other office or place of profit with our Company (except that of auditor) in conjunction with his office of Director for such period and upon such terms as the Board may determine, and may be paid such extra remuneration for that other office or place of profit, in whatever form, as the Board may determine. A Director may be or become a director or other officer of, or be otherwise interested in, any company promoted by our Company or any other company in which our Company may be interested and shall not be liable to account to our Company or the shareholders for any remuneration, profit or other benefit received by him as a director or officer of or from his interest in such other company. The Board may also cause the voting power conferred by the shares in any other company held or owned by our Company to be exercised in such manner in all respects as it thinks fit, including the exercise in favour of any resolution appointing the Directors or any of them to be directors or officers of such other company, or voting or providing for the payment of remuneration to the directors or officers of such other company. A Director shall not vote or be counted in the quorum on any resolution of the Board concerning his own appointment as the holder of any office or place of

profit with our Company or any other company in which our Company is interested (including the arrangement or variation of the terms, or the termination, of such appointment).

Subject to the provisions of the Companies Act, no Director or proposed or intended Director shall be disqualified by his office from contracting with our Company, nor shall any such contract or any other contract or arrangement in which any Director is in any way interested be liable to be avoided, nor shall any Director so contracting or being so interested be liable to account to our Company or the shareholders for any benefits realised by any such contract or arrangement by reason of such Director holding that office or the fiduciary relationship established by it. A Director who to his knowledge is in any way, whether directly or indirectly, interested in a contract or arrangement or proposed contract or arrangement with our Company must declare the nature of his interest at the meeting of the Board at which the question of entering into the contract or arrangement is first taken into consideration, if he knows his interest then exists, or in any other case at the first meeting of the Board after he knows that he is or has become so interested.

Save as otherwise provided by the Bye-laws, a Director shall not vote (nor shall he be counted in the quorum) on any resolution of the Board in respect of any contract or arrangement in which he or any of his close associates has a material interest, and if he does so his vote shall not be counted, but this prohibition will not apply to any of the following matters:

- (aa) the giving of any security or indemnity to the Director or his close associate(s) in respect of money lent or obligations incurred or undertaken by him or any of them at the request of or for the benefit of our Company or any of its subsidiaries;
- (bb) the giving of any security or indemnity to a third party in respect of a debt or obligation of our Company or any of its subsidiaries for which the Director or his close associate(s) has/have himself/themselves assumed responsibility in whole or in part whether alone or jointly under a guarantee or indemnity or by the giving of security;
- (cc) any proposal concerning an offer of shares, debentures or other securities of or by our Company or any other company which our Company may promote or be interested in for subscription or purchase, where the Director or his close associate(s) is/are or is/are to be interested as a participant in the underwriting or sub-underwriting of the offer;

- (dd) any proposal or arrangement concerning the benefit of employees of our Company or its subsidiaries, including, the adoption, modification or operation of either: (i) any employees' share scheme or any share incentive or share option scheme under which the Director or his close associate(s) may benefit; or (ii) any pension fund or retirement, death or disability benefits scheme which relates to Directors, their close associates and employees of our Company or any of its subsidiaries and does not provide in respect of any Director or his close associate(s) any privilege or advantage not generally accorded to the class of persons to which such scheme or fund relates; and
- (ee) any contract or arrangement in which the Director or his close associate(s) is/are interested in the same manner as other holders of shares, debentures or other securities of our Company by virtue only of his/their interest in those shares, debentures or other securities.

(c) Alterations to the constitutional documents and our Company's name

The Memorandum may, with the consent of the Minister of Finance of Bermuda (the "**Minister**") (if required), be altered by our Company in general meeting. The Bye-laws may be amended by the Directors subject to the approval of our Company in general meeting. The Bye-laws state that a special resolution is required to alter the Memorandum, to approve any amendment of the Bye-laws or to change the name of our Company.

(d) Meetings of shareholders

(i) Special resolutions

A special resolution of our Company must be passed by a majority of not less than three-fourths of the votes cast of such shareholders as, being entitled so to do, vote in person or, where a corporate representative is allowed, by a duly authorized corporate representative or, where proxies are allowed, by proxy at a general meeting of which notice specifying the intention to propose the resolution as a special resolution has been duly given.

(ii) Voting rights and right to demand a poll

Subject to any special rights, privileges or restrictions as to voting for the time being attached to any class or classes of shares, at any general meeting: (a) on a poll, every shareholder present in person or by a duly authorized corporate representative or by proxy shall have one vote for every share of which he is the holder which is fully paid up or credited as fully paid (but so that no amount paid up or credited as paid up on a share in advance of calls or instalments is treated for the foregoing purposes as paid up on the share); and (b) on a show of hands

every shareholder who is present in person or by a duly authorized corporate representative or by proxy shall have one vote. On a poll, a shareholder entitled to more than one vote need not use all his votes or cast all the votes in the same way.

At any general meeting a resolution put to the vote of the meeting shall be decided by poll save that the chairman of the meeting may, pursuant to the Listing Rules, allow a resolution to be voted on by a show of hands. Where a show of hands is allowed, before or on the declaration of the result of the show of hands, a poll may be demanded by (in each case by shareholders present in person or by proxy or by a duly authorized corporate representative): (i) at least three shareholders for the time being entitled to vote at the meeting; or (ii) any shareholder or shareholders representing not less than one-tenth of the total voting rights of all the shareholders having the right to vote at the meeting; or (iii) a shareholder or shareholders holding shares in our Company conferring a right to vote at the meeting on which an aggregate sum has been paid up equal to not less than one-tenth of the total sum paid up on all the shares conferring that right.

Where a shareholder is a recognised clearing house within the meaning of the Securities and Futures Ordinance (Chapter 571 of the Laws of Hong Kong), it may appoint such person or persons as it thinks fit to act as its proxy or proxies or as its corporate representative or representatives, to the extent permitted by the Companies Act, at any shareholders' general meeting or any meeting of any class of shareholders, provided that if more than one proxy or corporate representative is so appointed, the appointment shall specify the number and class of shares in respect of which each such proxy or corporate representative is to be appointed. The number of persons a clearing house may appoint to act as its corporate representative or representatives shall not exceed the number of shares held by the clearing house (or its nominee), being shares in respect of which there is an entitlement to attend and vote at the relevant meeting.

(iii) Annual general meetings

An annual general meeting must be held once in every year and within not more than 15 months after the last preceding annual general meeting.

(iv) Notices of meetings and business to be conducted

An annual general meeting of our Company shall be called by at least 21 days' notice in writing and any other general meeting shall be called by at least 14 days' notice in writing (in each case exclusive of the day on which the notice is served or deemed to be served and of the day for which it is given). The notice shall specify the place, the day and the hour of meeting and, in the case of special business, the general nature of that business.

Any notice or document to be given to or by any person pursuant to these Bye-laws may be served on or delivered to any shareholder of our Company personally, by post to such shareholder's registered address or (other than share certificates) by advertisement in at least one English language newspaper and one Chinese language newspaper circulating generally in Hong Kong. Subject to the applicable laws of Bermuda and any rules prescribed by the Hong Kong Stock Exchange from time to time, a notice or document may be served or delivered by our Company to any shareholder by electronic means.

(v) Quorum for meetings and separate class meetings

The quorum for a general meeting shall be two shareholders present in person or by a duly authorized corporate representative or by proxy and entitled to vote. In respect of a separate class meeting convened to sanction the modification of class rights, the necessary quorum shall be two persons holding or representing by proxy or by a duly authorized corporate representative one-third in nominal value of the issued shares of that class.

(vi) Proxies

Any shareholder of our Company entitled to attend and vote at a meeting of our Company or a meeting of the holders of any class of shares in our Company is entitled to appoint another person as his proxy to attend and vote instead of him. Votes, whether on a show of hands or on a poll, may be given either personally or by a duly authorized corporate representative or by proxy. A shareholder holding two or more shares may appoint more than one proxy to attend on the same occasion. A proxy need not be a shareholder of our Company.

The instrument appointing a proxy shall be in writing under the hand of the appointor or of his attorney duly authorized in writing, or if the appointor is a corporation, either under seal or under the hand of a duly authorized officer or attorney.

The instrument appointing a proxy to vote at a general meeting shall: (i) be deemed to confer authority upon the proxy to demand or join in demanding a poll and to vote on any resolution (or an amendment to any resolution) put to the meeting for which it is given as the proxy thinks fit; and (ii) unless the contrary is stated therein, be valid as well for any adjournment of the meeting as for the meeting to which it relates. Any form issued to a shareholder for appointing a proxy to attend and vote at a special general meeting or at an annual general meeting at which any business is to be transacted shall be such as to enable the shareholder, according to his intentions, to instruct the proxy to vote in favour of or against (or, in default of instructions, to exercise his discretion in respect of) each resolution dealing with any such business.

APPENDIX III

SUMMARY OF THE CONSTITUTION OF
OUR COMPANY AND BERMUDA COMPANY LAW

A proxy or proxies representing either an individual shareholder or a shareholder which is a corporation shall be entitled to exercise the same powers on behalf of the shareholder which he or they represent as such shareholder could exercise, including the right to vote individually on a show of hands.

(e) Accounts and audit

The Board shall cause true accounts to be kept of the sums of money received and expended by our Company, the property, assets, credits and liabilities of our Company and all other matters required by the Companies Act affecting our Company or necessary to give a true and fair view of the state of our Company's affairs and to show and explain its transactions.

The books of account are to be kept at the head office or at such other place as the Board thinks fit and shall always be open to the inspection of the Directors provided that such records as are required by the Companies Act shall also be kept at the registered office. No shareholder (not being a Director) or other person has any right to inspect any account, book or document of our Company except as conferred by the Companies Act or ordered by a court of competent jurisdiction or authorized by the Board or our Company in general meeting.

The Board shall from time to time cause to be prepared and laid before our Company at its annual general meeting such profit and loss accounts, balance sheets, group accounts (if any) and reports as are required by the Companies Act. Every balance sheet of our Company shall be signed on behalf of the Board by two Directors and a copy of every balance sheet (including every document required by law to be comprised therein or attached or annexed thereto) and profit and loss account which is to be laid before our Company at its annual general meeting, together with a copy of the Directors' report and a copy of the auditors' report, shall not less than 21 days before the date of the meeting be sent to every shareholder of, and every holder of debentures of, our Company and every other person entitled to receive notices of general meetings of our Company under the Companies Act or the Bye-laws. If all or any of the shares or debentures of our Company are for the time being (with the consent of our Company) listed or dealt in on any stock exchange, there shall be forwarded to the appropriate officer of such stock exchange such number of copies of such documents as are for the time being required under its regulations or practice.

Auditors shall be appointed and their duties regulated in accordance with the Companies Act. Subject as otherwise provided by the Companies Act, the remuneration of the auditors shall be fixed by or on the authority of our Company at each annual general meeting but, in respect of any particular year, our Company in general meeting may delegate the fixing of such remuneration to the Board.

(f) Dividends and other methods of distribution

Our Company in general meeting may declare dividends in any currency but no dividends shall exceed the amount recommended by the Board.

Unless and to the extent that the rights attached to any shares or the terms of their issue otherwise provide, all dividends shall be apportioned and paid pro rata according to the amounts paid or credited as paid up on the shares during any portion or portions of the period in respect of which the dividend is paid. No amount paid upon a share in advance of calls will for this purpose be treated as paid up on the shares. The Board may retain any dividends or other moneys payable on or in respect of a share upon which our Company has a lien, and may apply the same in or towards satisfaction of the debts, liabilities or engagements in respect of which the lien exists. The Board may deduct from any dividend or bonus payable to any shareholder all sums of money (if any) presently payable by him to our Company on account of calls, instalments or otherwise.

Whenever the Board or our Company in general meeting has resolved that a dividend be paid or declared on the share capital of our Company, the Board may further resolve either: (a) that such dividend be satisfied wholly or in part in the form of an allotment of shares credited as fully paid up, provided that the shareholders entitled to such dividend will be entitled to elect to receive such dividend (or part thereof) in cash in lieu of such allotment; or (b) that the shareholders entitled to such dividend will be entitled to elect to receive an allotment of shares credited as fully paid up in lieu of the whole or such part of the dividend as the Board thinks fit. Our Company may also, upon the recommendation of the Board, by a special resolution resolve in respect of any one particular dividend of our Company that it may be satisfied wholly in the form of an allotment of shares credited as fully paid up without offering any right to shareholders to elect to receive such dividend in cash in lieu of such allotment.

Whenever the Board or our Company in general meeting has resolved that a dividend be paid or declared, the Board may further resolve that such dividend be satisfied wholly or in part by the distribution of specific assets of any kind.

The Board may, if it thinks fit, receive from any shareholder willing to advance the same, and either in money or money's worth, all or any part of the money uncalled and unpaid or instalments payable upon any shares held by him, and in respect of all or any of the moneys so advanced may pay interest at such rate (if any) not exceeding 20% per annum, as the Board may decide but a payment in advance of a call shall not entitle the shareholder to receive any dividend subsequently declared or to exercise any other rights or privileges as a shareholder in respect of the share or the due portion of the shares upon which payment has been advanced by such shareholder before it is called up.

All dividends or bonuses unclaimed for one year after having been declared may be invested or otherwise used by the Board for the benefit of our Company until claimed and our Company shall not be constituted a trustee in respect thereof. All dividends or bonuses unclaimed for six years after having been declared may be forfeited by the Board and shall revert to our Company.

Our Company may exercise the power to cease sending cheques for dividend entitlements or dividend warrants by post if such cheques or warrants have been left uncashed on two consecutive occasions or after the first occasion on which such a cheque or warrant is returned undelivered.

(g) Inspection of register of members

There are no provisions in the Bye-laws relating to inspection of the register of members.

(h) Rights of the minorities in relation to fraud or oppression

There are no provisions in the Bye-laws relating to rights of minority members in relation to fraud or oppression. However, Bermuda company law provides for protection of minorities, as summarised in paragraph 3(o) of this Appendix.

(i) Procedures on liquidation

A resolution that our Company be wound up by the court or be wound up voluntarily shall be a special resolution.

If our Company is wound up, the surplus assets remaining after payment to all creditors are to be divided among the shareholders in proportion to the capital paid up on the shares held by them respectively, and if such surplus assets are insufficient to repay the whole of the paid up capital, they are to be distributed so that, as nearly as may be, the losses shall be borne by the shareholders in proportion to the capital paid up on the shares held by them respectively, all subject to the rights of any shares issued on special terms and conditions.

If our Company is wound up (whether the liquidation is voluntary or by the court) the liquidator may, with the sanction of a special resolution, divide among the shareholders in specie or kind the whole or any part of the assets of the Company and whether the assets consist of property of one kind or different kinds and the liquidator may, for such purpose, set such value as he deems fair upon any one or more class or classes of property to be so divided and may determine how such division is to be carried out as between the shareholders or different classes of shareholders and the shareholders within each class. The liquidator may, with like sanction, vest any part of the assets in trustees upon such trusts for the benefit of shareholders as the liquidator thinks fit, but so that no shareholder shall be compelled to accept any shares or other assets upon which there is a liability.

(j) Untraceable shareholders

Our Company shall have the power to sell, in such manner as the Board thinks fit, any shares of a shareholder who is untraceable, but no such sale shall be made unless:

- (i) all cheques or warrants, being not less than three in total number, for any sum payable in cash to the holder of such shares in respect of them sent during the relevant period in the manner authorized by the Bye-Laws of our Company have remained uncashed;
- (ii) so far as it is aware at the end of the relevant period, our Company has not at any time during the relevant period received any indication of the existence of the shareholder who is the holder of such shares or of a person entitled to such shares by death, bankruptcy or operation of law;
- (iii) our Company has caused an advertisement to be inserted in the newspapers of its intention to sell such shares and a period of three months has elapsed since the date of such advertisement; and
- (iv) our Company has notified the relevant stock exchange of its intention to effect such sale.

For the purpose of the foregoing, “relevant period” means the period commencing twelve years before the date of publication of the advertisement referred to in paragraph (iii) above and ending at the expiry of the period referred to in that paragraph.

(k) Other provisions

Subject to the Companies Act, if any of the rights attached to any warrants issued by our Company shall remain exercisable and our Company does any act which would result in the subscription price under such warrants being reduced below the par value of a share, a subscription right reserve shall be established and applied in paying up the difference between the subscription price and the par value of a share on any exercise of the warrants.

The Companies Act prevents a company from giving financial assistance in the subscription of its shares subject to certain exceptions. As such a subscription right reserve may only be created and used for the above purpose if an exception applies.

3. BERMUDA COMPANY LAW

Certain aspects of Bermuda company law are set out below but this summary does not purport to contain all applicable qualifications and exemptions or to be a complete review of all matters of Bermuda company law or a comparison of provisions that may differ from the laws of other jurisdictions with which interested parties may be more familiar.

(a) Incorporation

Our Company was incorporated by registration pursuant to the provisions of the Companies Act on June 13, 2000. Our Company was brought into existence by depositing its Memorandum with the Registrar of Companies in Bermuda (the “Registrar”).

(b) Constituent documents

The business activities of a Bermuda company are governed by the provisions of its memorandum of association which sets out its specific business objects and the powers that may be exercised in support of its principal business objects. Bermuda law distinguishes between objects and powers, the latter being regarded as supplemental to the principal business objects.

The objects set out or included by reference in the different paragraphs of the objects clause in a company’s memorandum of association shall not, unless otherwise stated, be limited or restricted in any way by reference to or inference from the terms of any other paragraph in the memorandum of association and such objects may be carried out in as full and ample a manner and construed in such a manner as if each paragraph defined the objects of a separate and independent company and each is construed as a primary object.

A company may, by resolution passed at a general meeting of members of which due notice has been given, alter its memorandum of association. After approval of the alteration by the members in general meeting, certain filings must be made with the Registrar. It is also necessary to obtain the Minister’s consent to the alteration if the company carries on any “restricted business activity” as defined in the Companies Act.

The bye-laws govern a company’s administration and the relationship between its members and its board of directors, and are required to make provision for certain limited matters.

The members of a company are entitled to receive copies of the company’s memorandum of association and bye-laws upon request. Each person who agrees to become a member of a company and whose name is entered in the register of members is deemed to be a member of the company.

(c) Taxation

In Bermuda there are no taxes on profits, income or dividends, nor is there any capital gains tax, estate duty or death duty. Profits can be accumulated and it is not obligatory for a company to pay dividends. Companies are required to pay an annual government fee (the “**Government Fee**”), which is determined on a sliding scale by reference to a company’s authorized share capital and share premium account, with the minimum fee being BDS\$1,995 and the maximum fee being BDS\$31,120 (Bermuda dollar is treated at par with U.S. dollar). The Government Fee is payable at the end of January in every year and is based on the authorized share capital and share premium account as they stood at August 31, in the preceding year.

The Minister is authorized to give an assurance to an exempted company or a partnership that, in the event of there being enacted in Bermuda any legislation imposing tax on profits, income or any capital asset, gain or appreciation, then the imposition of any such tax shall not be applicable to such entity or any of its operations. In addition, there may be included an assurance that any such tax, or any tax in the nature of estate duty or inheritance tax, shall not be applicable to the shares, debentures or other obligations of such entity. This assurance has been obtained by our Company for a period ending March 31, 2035.

(d) Stamp duty

Stamp duty is not chargeable in respect of the incorporation, registration or licensing of an exempted company, nor, subject to certain minor exceptions, on its transactions. Accordingly, no stamp duty will be payable on the increase in or the issue or transfer of the share capital of our Company.

(e) Prospectus issues and public offers

Save as described below, before or as soon as reasonably practicable after an offer of shares by a company to the public (as defined in the Companies Act), the company must publish, in writing, a prospectus signed by or on behalf of all its directors and file a copy of that prospectus with the Registrar. A certificate, signed by an attorney in Bermuda, must be filed with the prospectus, certifying that the prospectus contains certain particulars required by the Companies Act and is accompanied by a written statement from the auditor of the company in which the auditor confirms his consent to the inclusion of his report in the prospectus to be issued by the company. It is not necessary for a company to publish and file a prospectus at any time or in any circumstances, where:

- (i) the shares are listed on an appointed stock exchange, or an application has been made for the shares to be so listed, and the rules of the appointed stock exchange do not require the company to publish and file a prospectus at such time or in such circumstances;

- (ii) the company is subject to the rules or regulations of a competent regulatory authority and such rules or regulations do not require the company to publish and file a prospectus at such time or in such circumstances, except where exemption from publication and filing of a prospectus is given by reason of the offer being made only to persons who are resident outside the jurisdiction of the authority; or
- (iii) an appointed stock exchange or any competent regulatory authority has received or otherwise accepted a prospectus or other document in connection with the offer of shares to the public.

A number of stock exchanges and regulatory authorities have been approved by the Minister and designated as appointed stock exchanges and competent regulatory authorities, including the Hong Kong Stock Exchange and the SFC, respectively.

(f) Exchange control

Although incorporated in Bermuda, our Company has been classified as non-resident in Bermuda for exchange control purposes by the Bermuda Monetary Authority (“BMA”). Accordingly, our Company may convert currency (other than Bermuda currency) held for its account to any other currency without restriction.

Persons, firms or companies regarded as residents of Bermuda for exchange control purposes require specific consent under the Exchange Control Act 1972 of Bermuda, and regulations thereunder, to purchase or sell shares or warrants of a non-resident company such as our Company which are regarded as foreign currency securities by the BMA. Where any equity securities of a Bermuda company are listed on an appointed stock exchange (which includes the Hong Kong Stock Exchange), general permission is given for the issue and subsequent transfer of any securities of the company from and/or to a non-resident of Bermuda, for as long as any equity securities of the company remain so listed.

In granting such permission, the BMA accepts no responsibility for the financial soundness of any proposals or for the correctness of any statements made or opinions expressed in this document with regard to them.

(g) Share capital

Where a company issues shares at a premium, whether for cash or otherwise, a sum equal to the aggregate amount or value of the premium on those shares shall be transferred to an account, to be called “the share premium account” and the provisions of the Companies Act relating to a reduction of share capital of a company shall, except in limited circumstances, apply as if the share premium account were paid up share capital of the company. An exception is made to this rule in the case of an exchange of shares where the excess value of the shares acquired over the nominal value of the shares being issued may be credited to a contributed surplus account of the

issuing company. Contributed surplus is a North American concept recognised under the generally accepted accounting principles of the Canadian Institute of Chartered Accountants, which accounting principles are applied in Bermuda.

A company may issue preference shares and under certain circumstances to convert those preference shares into redeemable preference shares.

(h) Alteration of share capital

A company may, if authorized by a general meeting of its members and by its by-laws, alter the conditions of its memorandum of association to increase its share capital, divide its shares into several classes and attach to those shares any preferential, deferred, qualified or special rights, privileges or conditions, consolidate all or any of its share capital into shares of a larger amount than its existing shares, subdivide its shares or any of them into shares of a smaller amount than is fixed by the memorandum of association, make provision for the issue and allotment of shares which do not carry any voting rights, cancel shares which have not been taken or agreed to be taken by any person, diminish the amount of its share capital by the amount of the shares so cancelled and change the currency denomination of its share capital. With the exception of an increase of capital, cancellation of shares and redenomination of currency of capital, there are no filing requirements for any such alterations.

Furthermore a company may, if authorized by a general meeting of its members, reduce its share capital. There are certain requirements, including a requirement before the reduction to publish a notice in an appointed newspaper stating the amount of the share capital as last determined by the company, the amount to which the share capital is to be reduced and the date on which the reduction is to have effect. A company is not permitted to reduce the amount of its share capital if on the date the reduction is to be effected there are reasonable grounds for believing that the company is, or after the reduction would be, unable to pay its liabilities as they become due.

The Companies Act includes certain protections for holders of special classes of shares requiring their consent to be obtained before their rights may be varied.

As soon as practicable after the allotment of any of its shares, a company must complete and have ready for delivery share certificates in relation to those shares unless the conditions of issue of the shares provide otherwise. A certificate under the common seal of the company shall be prima facie evidence of the title of the member to the shares. A company is not permitted to allot and issue bearer shares.

(i) Purchase by a company of its own shares

If authorized to do so by its memorandum of association or bye-laws, a company may purchase its own shares. Such purchases may only be effected out of the capital paid up on the purchased shares, profits otherwise available for dividend (see “Dividends and distributions” below) or out of the proceeds of a new issue of shares

made for the purpose. Any premium payable on a repurchase over the par value of the shares to be repurchased must be provided for out of the profits otherwise available for dividends, out of the company's share premium account, or out of contributed surplus. A purchase by a company of its own shares may be authorized by its board of directors or otherwise by or in accordance with the provisions of its bye-laws. Further, the consideration payable to a member whose shares are repurchased may be satisfied by cash and/or the transfer of any part of the undertaking or property of the company or a combination of them.

No purchase by a company of its own shares may be effected if, on the date on which the purchase is to be effected, there are reasonable grounds for believing that the company is, or after the purchase would be, unable to pay its liabilities as they become due.

The shares purchased shall be treated as cancelled and the amount of the company's issued capital shall be diminished by the nominal amount of those shares accordingly. It shall not be taken as reducing the amount of the company's authorized share capital.

A company is not prevented from purchasing and may purchase its own warrants. There is no requirement of Bermuda law that the memorandum of association or the bye-laws contain a specific enabling provision authorising any such purchase and the directors may rely upon the general power to buy and sell and deal in personal property of all kinds.

A company has power to hold and purchase shares of its holding company. A distinction must be drawn between the purchase of shares in the holding company by the holding company itself and the purchase by a subsidiary. A holding company can only purchase its own shares in accordance with the provisions referred to above. When a subsidiary acquires shares in its holding company, the shares, once purchased, may be voted by the subsidiary for its own benefit.

(j) Transfer of securities

Title to securities of companies whose securities are traded or listed on an appointed stock exchange may, only with effect from the coming into operation of regulations made by the Minister, be evidenced and transferred without a written instrument either in accordance with regulations made by the Minister or by a person appointed by the Minister, namely through the mechanism required or permitted by an appointed stock exchange.

(k) Dividends and distributions

A company shall not declare or pay a dividend or make a distribution out of contributed surplus, if there are reasonable grounds for believing that: (a) the company is, or would after the payment be, unable to pay its liabilities as they become due; or (b) the realisable value of the company's assets would thereby be less than the aggregate of its liabilities and its issued share capital and share premium accounts.

Contributed surplus for these purposes is defined as including proceeds arising from donated shares, credits resulting from the redemption or conversion of shares at less than the amount set up as nominal capital, the excess value of shares acquired over those issued in a share exchange should the board of directors elect to treat it as such and donations of cash and other assets to the company.

(l) Charges on the assets of a company

The Companies Act established a register of charges at the office of the Registrar permitting any charges on the assets of a company to be registered. Registration is not mandatory but does govern priority in Bermuda, giving a registered charge priority over any subsequently registered charge and over all unregistered charges save those in effect prior to the coming into effect of the Companies Act in July of 1983. The register of charges is available for inspection by members of the public. A series of debentures may also be registered.

(m) Management and administration

The management and administration of a Bermuda company shall be vested in the hands of not less than one director duly elected by the members.

The Companies Act requires that a Bermuda company maintains: (a) at least one director (other than an alternate director) who is ordinarily resident in Bermuda; or (b) a secretary or a resident representative which is either an individual or a company ordinarily resident in Bermuda.

The Companies Act contains no specific restrictions on the power of the directors of a company to resolve to dispose of assets of the company although it specifically requires that every officer of a company, in exercising his powers and discharging his duties, shall act honestly and in good faith with a view to the best interests of the company and exercise the care, diligence and skill that a reasonably prudent person would exercise in comparable circumstances. Furthermore every officer is required to comply with the Companies Act, regulations passed pursuant to the Companies Act and the company's bye-laws.

(n) Loans to directors

A company is not permitted to make loans to any of its directors or to their families or companies in which they hold a 20% interest, without the consent of members of the company holding in aggregate not less than nine-tenths of the total voting rights of all members having the right to vote at any meeting of the members of the company. These prohibitions do not apply to anything done to provide a director with funds to meet expenditure incurred or to be incurred by him for the purposes of the company, provided that the company gives its prior approval at a general meeting or, if not, the loan is made on condition that it shall be repaid within six months of the next annual general meeting if the loan is not approved at such meeting. If the approval of the company is not given for a loan, the directors who authorized it will be jointly and severally liable for any loss arising.

(o) The investigation of the affairs of a company and the protection of minorities

The Minister may, at any time of his own volition, appoint one or more inspectors to investigate the affairs of an exempted company and to report on that investigation in such manner as he may direct. Such an investigation shall be made in private unless the company requests that it be held in public. Furthermore, if any member of a company complains that the affairs of the company are being conducted or have been conducted in a manner oppressive or prejudicial to the interests of some part of the members or a report has been made to the Minister pursuant to an investigation, the Registrar on behalf of the Minister may make an application to the court. If the court is of the opinion that the company's affairs are being, or have been, conducted in a manner oppressive or prejudicial to the interests of some part of the members and that to wind up the company would unfairly prejudice that part of the members but otherwise the facts would justify the making of a winding up order on the ground that it would be just and equitable that the company should be wound up, then it may make such order as it thinks fit whether for regulating the conduct of the company's affairs in future or for the purchase of shares of any members of the company by other members of the company or by the company and, in the case of a purchase by the company, for the reduction accordingly of the company's capital, or otherwise.

Class actions and derivative actions are generally not available to members under the laws of Bermuda; however, the Bermuda courts ordinarily would expect to follow English case law precedent which would permit a member to commence an action in the name of the company to remedy a wrong done to the company where the act complained of is alleged to be beyond the corporate power of the company or is illegal or would result in the violation of the company's memorandum of association or by-laws. Furthermore, consideration would be given by the court to acts that are alleged to constitute a fraud against the minority members or, for instance, where an act requires the approval of a greater percentage of the company's members than that which actually approved it.

In addition to the above, members may be able to bring claims against a company; such claims must, however, be based on the general laws of contract or tort applicable in Bermuda.

A statutory right of action is conferred on subscribers to shares of a company against persons (including directors and officers) responsible for the issue of a prospectus in respect of damage suffered by reason of an untrue statement in that prospectus but this confers no right of action against the company itself. In addition, the company may take action against the officers for breach of their statutory and fiduciary duty to act honestly and in good faith with a view to the best interests of the company. Furthermore, a subscriber is not debarred from obtaining damages or other compensation from the company by reason only of his holding or having held shares in the company or any right to apply or subscribe for shares or to be included in the company's register of members in respect of shares.

(p) Inspection of corporate records

Members of the general public have the right to inspect the public documents of a company available at the office of the Registrar, which include the company's certificate of incorporation, its memorandum of association and any alteration to the memorandum of association and documents relating to an increase or reduction of authorized capital. The members have the additional right to inspect the bye-laws, minutes of general meetings and audited financial statements of the company, which must be presented to the annual general meeting of members.

A company is required to maintain its share register in Bermuda but may establish a branch register outside Bermuda. The register of members of the company and any branch register are also open to inspection by members without charge, and to general members of the public for a fee. Where a member of the company or other person requests a copy of the register of members or branch register, this must be provided within 14 days of the request. Each company is required to keep at its registered office a register of its directors and officers which is open for inspection by members of the public without charge. Bermuda law does not, however, provide a general right for members to inspect or obtain copies of any other corporate records.

(q) Restrictions on the activities of exempted companies

Unless specifically authorized by its memorandum of association, an exempted company is not permitted to acquire, hold or take a mortgage of land in Bermuda (subject to certain exceptions), or acquire any bonds or debentures secured on any land in Bermuda except for bonds or debentures issued by the government or a public authority in Bermuda.

Exempted companies are specifically permitted to carry on business with persons outside Bermuda or to do business in Bermuda with an exempted company in furtherance only of the business of the exempted company carried on outside Bermuda. It may buy, sell or otherwise deal in shares, bonds, debenture stock obligations,

mortgages or other securities issued or created by an exempted undertaking or a local company or any partnership which is not an exempted undertaking. It may transact banking business with a bank licensed in Bermuda. It may effect or conclude contracts in Bermuda and exercise in Bermuda all other powers so far as may be necessary for carrying on its business with persons outside Bermuda. It may act as manager or agent for or consultant or advisor to the business of another exempted company, provided that other company has an object in its memorandum of association to enable it to carry on such type of business.

Our Company has been incorporated as an “exempted company”. Accordingly, our Company is authorized to carry on business outside Bermuda from a place of business in Bermuda but may not, without a specific licence granted by the Minister, conduct business within Bermuda. Our Company is, therefore, permitted to establish a place of business in Bermuda in order to conduct business outside Bermuda or with other exempted companies in Bermuda. However, it may not engage in trading or other business activities in Bermuda. Furthermore, as an exempted company, our Company has been designated as “non resident” for exchange control purposes and is authorized to deal in any currency of its choosing, other than Bermuda dollars.

(r) Accounting and auditing requirements

A company shall cause to be kept proper records of account with respect to: (i) all sums of money received and expended by the company; (ii) all sales and purchases of goods by the company; and (iii) the assets and liabilities of the company.

The records of account shall be kept at the registered office of the company or at such other place as the directors of the company think fit and shall at all times be open to inspection by the directors or by a resident representative. These records of account shall also be maintained at the office of the resident representative if the company has appointed such a resident representative. If the records of account are kept at some place outside Bermuda, there shall be kept at an office of the company in Bermuda such records as will enable the directors or the resident representative to ascertain with reasonable accuracy the financial position of the company at the end of each three month period (or each six month period, where the company is listed on an appointed stock exchange). Power is vested in the courts of Bermuda to order the company to make available the records of account to any of the directors should the company for some reason refuse to do so.

The board of every company shall, at least once in every year, lay before the company in general meeting: (i) financial statements for the period (the details of which are prescribed in the Companies Act); (ii) the report of the auditor in respect of the financial statements; and (iii) the notes to the financial statements, which shall include a description of the generally accepted accounting principles used in the preparation of the financial statements and, where the accounting principles used are those of a country or jurisdiction other than Bermuda, shall disclose this fact and name the country or jurisdiction.

APPENDIX III**SUMMARY OF THE CONSTITUTION OF
OUR COMPANY AND BERMUDA COMPANY LAW**

The financial statements to be laid before the members in general meeting shall be signed on the balance sheet by a director of the company.

If for some reason it becomes impossible, for reasons beyond the reasonable control of the directors, to lay the financial statements before the members, it shall be lawful for the chairman of the meeting to adjourn the meeting for a period of up to 90 days or such longer period as the members may agree.

All members of a company are entitled to receive a copy of the financial statements prepared in accordance with the requirements described above, at least seven days before the general meeting of the company at which the financial statements would be tabled.

Companies listed on an appointed stock exchange may send summarised financial statements instead of the unabridged financial statements mentioned above. Each member can elect to receive unabridged financial statements for that period and/or any subsequent period. The summarised financial statements together with the auditors report and notice to elect to receive the unabridged financial statements must be sent to members 21 days before the general meeting. A company shall send the full financial statements to a member within seven days of receipt of the member's election to receive the full financial statements.

The summarised financial statements must be derived from the company's financial statements and shall include: (a) a summarised report of the unabridged financial statements; (b) such further information extracted from the financial statements as the board of directors considers appropriate; and (c) a statement that it is only a summarised version of the company's financial statements.

There are certain exceptions in the case of members not entitled to receive notices of general meetings, joint holders of shares or where the address for a person is not known to the company.

The members in general meeting have the power to waive the laying of the financial statements and auditors' report and to waive the appointment of an auditor if all the members and directors of the company agree, either in writing or at a general meeting, that in respect of a particular interval no financial statement or auditors' report need be laid before a general meeting.

The Companies Act contains specific requirements in relation to the appointment and disqualification of an auditor.

(s) Continuation and discontinuation of companies

- (i) A company incorporated outside Bermuda may be continued in Bermuda as an exempted company to which the provisions of the Companies Act and any other relevant laws of Bermuda may apply. The consent of the Minister will be required if the company's memorandum of continuance includes special objects enabling it to carry on any "restricted business activity" as defined in the Companies Act; and
- (ii) an exempted company may be continued in a country or jurisdiction outside Bermuda as if it had been incorporated under the laws of that other jurisdiction and be discontinued under the Companies Act, provided that, *inter alia*, it is an appointed jurisdiction pursuant to the Companies Act, or has been approved by the Minister, upon application by the company for the purpose of the discontinuance of the company out of Bermuda.

(t) Winding-up and liquidation**(i) Introduction:**

The winding-up of Bermuda companies is governed by the provisions of the Companies Act and by the Companies (Winding-Up) Rules 1982 and may be categorised as either into a voluntary winding up or a compulsory winding-up.

(ii) Voluntary Winding-Up:

- (aa) **Members' Voluntary Winding-up** — A members' voluntary winding-up is only possible if a company is solvent. A statutory declaration of solvency to the effect that a company is able to meet its debts within 12 months from the date of the commencement of its winding-up is sworn by a majority of the company's directors and filed with the Registrar.

A general meeting of members is then convened which resolves that the company be wound-up voluntarily and that a liquidator be appointed.

Once the affairs of the company are fully wound-up, the liquidator prepares a full account of the liquidation which he then presents to the company's members at a special general meeting called for that purpose. This special general meeting must be advertised in an appointed newspaper in Bermuda at least one month before it is held. Within one week after this special general meeting is held, the liquidator shall notify the Registrar that the company has been dissolved.

(bb) **Creditors' Voluntary Winding-up** — A creditors' voluntary winding-up may occur where a company is insolvent and a statutory declaration of solvency cannot be sworn.

A board meeting is convened which resolves to recommend to the members of the company that the company be placed into a creditors' voluntary winding-up. This recommendation is then considered and, if thought fit, approved at a special general meeting of the company's members and, subsequently, at a meeting of the company's creditors.

Notice of the creditors' meeting must appear in an appointed newspaper on at least two occasions and the directors must provide this meeting with a list of the company's creditors and a full report of the position of the company's affairs.

At their respective meetings, the creditors and members are entitled to nominate a person or persons to serve as liquidator(s). In addition, the creditors are entitled to appoint a committee of inspection which, under Bermuda law, is a representative body of creditors who assist the liquidator during the liquidation.

As soon as the affairs of the company are fully wound-up, the liquidator prepares his final account explaining the liquidation of the company and the distribution of its assets which he then presents to the company's members in a special general meeting and to the company's creditors in a meeting. Within one week after the last of these meetings, the liquidator sends a copy of the account to the Registrar who proceeds to register it in the appropriate public records and the company is deemed dissolved three months after the registration of this account.

(iii) Compulsory Winding-Up:

The courts of Bermuda may wind-up a Bermuda company on a petition presented by persons specified in the Companies Act, which include the company itself and any creditor or creditors of the company (including contingent or prospective creditors) and any member or members of the company.

Any such petition must state the grounds upon which the Bermuda court has been asked to wind-up the company and may include, among others, any of the following:

(aa) that the company has by resolution resolved that it be wound-up by the Bermuda court;

(bb) that the company is unable to pay its debts; and

- (cc) that the Bermuda court is of the opinion that it is just and equitable that the company be wound-up.

The winding-up petition seeks a winding-up order and may include a request for the appointment of a provisional liquidator.

Prior to the winding-up order being granted and the appointment of the provisional liquidator, an interim provisional liquidator may be appointed to administer the affairs of the company with a view to its winding-up until he is relieved of these duties by the appointment of the provisional liquidator.

As soon as the winding-up order has been made, the provisional liquidator summons separate meetings of the company's creditors and members in order to determine whether or not he should serve as the permanent liquidator or be replaced by some other person who will serve as the permanent liquidator and also to determine whether or not a committee of inspection should be appointed and, if appointed, the members of that committee. The provisional liquidator notifies the court of the decisions made at these meetings and the court makes the appropriate orders.

A permanent liquidator's powers are prescribed by the Companies Act. His primary role and duties are the same as a liquidator in a creditors' voluntary winding-up, namely to distribute the company's assets ratably amongst its creditors whose debts have been admitted.

As soon as the affairs have been completely wound-up, the liquidator applies to the courts of Bermuda for an order that the company be dissolved and the company is deemed dissolved from the date of this order being made.

(u) General

Appleby, our Company's legal advisers on Bermuda law, has sent to our Company a letter of advice summarising certain aspects of the Bermuda company law. This letter, together with a copy of the Companies Act, is available for inspection as referred to in the paragraph headed "Documents Available for Inspection" in Appendix V to this prospectus. Any person wishing to have a detailed summary of Bermuda company law or advice on the differences between it and the laws of any jurisdiction with which he is more familiar is recommended to seek independent legal advice.

A. FURTHER INFORMATION ABOUT OUR GROUP**1. Incorporation**

- (a) Our Company was incorporated in Bermuda as an exempted company with limited liability under the Companies Act on June 13, 2000. Our Company has established the principal place of business in Hong Kong at Flats F–J, 11th Floor, Block One, Kwai Tak Industrial Centre, 15–33 Kwai Tak Street, Kwai Chung, New Territories, Hong Kong and has been registered as a non-Hong Kong company under Part XI of the Predecessor Companies Ordinance on May 28, 2002. Mr. Wong Tat Tong of House H3, Belleview Place, 93 Repulse Bay Road, Hong Kong has been appointed as the authorized representative of our Company for acceptance of service of process in Hong Kong.
- (b) As our Company was incorporated in Bermuda, it operates subject to the Companies Act and its constitution comprising the Memorandum of Association and the Bye-Laws. A summary of certain provisions of its constitution and relevant aspects of the Bermuda company law is set out in Appendix III to this prospectus.

2. Changes in the share capital of our Company

The following sets out the changes in the share capital of our Company during the two years immediately preceding the date of this prospectus:

- (a) On March 2, 2016, the Former Shareholder transferred 42,385,709 ordinary Shares of par value HK\$0.25 each of our Company, representing approximately 17.16% of the then issued share capital of our Company, to Hero Valour.
- (b) On September 4, 2017, 86,719 ordinary Shares of par value HK\$0.25 each, credited as fully paid, were allotted and issued to Hero Valour for a cash consideration of HK\$21,679.75.
- (c) On September 4, 2017, every two issued and unissued ordinary Shares of par value HK\$0.25 each were subdivided into five ordinary Shares of par value HK\$0.10 each, such that immediately following the Share Subdivision, the authorised share capital of our Company became HK\$100,000,000 divided into 1,000,000,000 Shares of par value HK\$0.10 each.
- (d) On September 4, 2017, the authorized share capital of our Company was increased from HK\$100,000,000 divided into 1,000,000,000 Shares of par value HK\$0.10 each to HK\$200,000,000 divided into 2,000,000,000 Shares of par value HK\$0.10 each, by the creation of 1,000,000,000 new Shares.

Save as disclosed above and in “4. Written resolutions of the sole Shareholder” below, there has been no alteration in the share capital of our Company during the two years immediately preceding the date of this prospectus.

3. Changes in the share capital of the subsidiaries of our Company

A summary of the corporate information and the particulars of our subsidiaries are set out in note 1 to the Accountants’ Report as set out in Appendix I to this prospectus.

The following sets out the changes in the share capital of our subsidiaries during the two years immediately preceding the date of this prospectus:

(a) HK TWG Heritage

On January 10, 2017, Heritage Teas (Private) Limited and Global Tea Trading transferred 300,000 and 435,000 shares of HK TWG Heritage, representing 20% and 29% of the issued share capital of HK TWG Heritage respectively, to TWCI.

(b) Whole Sun

On October 12, 2016, TWFF transferred 6,000 shares of Whole Sun, representing 60% of the issued share capital of Whole Sun, to TWIC.

Save as disclosed above, there has been no alteration in the share capital of the subsidiaries of our Company during the two years immediately preceding the date of this prospectus.

4. Written resolutions of the sole Shareholder

Pursuant to the written resolutions of the then sole Shareholder passed on December 15, 2017, among other things:

- (a) conditional on the fulfilment or waiver of, among other things, the conditions set out in the section headed “Structure of the Global Offering — Conditions of the Hong Kong Public Offering” in this prospectus (the “**Conditions**”):
 - (i) the Global Offering on the terms and conditions of this prospectus and the Application Forms at the Offer Price was approved and the Directors were authorized to allot and issue the new Shares;
 - (ii) conditional further on the Listing Committee granting the listing of, and the permission to deal in, such number of Shares which may be allotted pursuant to the exercise of the Over-allotment Option and the options which have been granted under the Pre-IPO Share Options Scheme and which may be granted under the Share Option Scheme, the Share Option Schemes were approved and adopted, and the Directors or any

committee of the Board were authorized, at their sole discretion, to make such further changes to the Share Option Schemes as requested by the Hong Kong Stock Exchange and which they may consider necessary, desirable or expedient in connection with the grant of options to subscribe for the Shares under the Share Option Schemes up to the limits as referred to in the Share Option Schemes and to allot, issue and deal with the Shares under the exercise of subscription rights attaching to the options granted under the Pre-IPO Share Option Scheme and options which may be granted under the Share Option Scheme and to take all such action as they may consider necessary, desirable or expedient to implement the Share Option Schemes;

- (iii) a general unconditional mandate was granted to the Directors to exercise all powers of our Company to allot, issue and deal with the Shares and to make or grant offers, agreements or options (including any warrants, bonds, notes and debentures conferring any rights to subscribe for or otherwise receive the Shares) which may require the Shares to be allotted and issued or dealt with subject to the restriction that the aggregate number of Shares so allotted and issued or agreed conditionally or unconditionally to be allotted and issued, other than under (A) a Rights Issue (as defined below); (B) any scrip dividend scheme or similar arrangement providing for the allotment and issue of the Shares in lieu of the whole or part of a dividend on the Shares in accordance with the Bye-Laws; (C) any specific authority granted by the Shareholders in general meeting; or (D) the exercise of any option which have been granted under the Pre-IPO Share Option Scheme and options which may be granted under the Share Option Scheme or any other share option scheme of our Company, shall not exceed 20% of the number of issued Shares immediately following completion of the Global Offering;
- (iv) a general unconditional mandate was granted to the Directors to exercise all powers of our Company to purchase on the Hong Kong Stock Exchange or on any other stock exchange on which the securities of our Company may be listed and which was recognised by the SFC and the Hong Kong Stock Exchange for this purpose, such number of Shares as would represent up to 10% of the number of issued Shares immediately following completion of the Global Offering; and
- (v) the general unconditional mandate as mentioned in paragraph 4(a)(iii) above was extended by the addition to the aggregate number of Shares which may be allotted and issued or agreed to be allotted and issued by the Directors under such general mandate of an amount representing the aggregate number of Shares purchased by our Company under the mandate to repurchase Shares as referred to in paragraph 4(a)(iv) above,

for the purpose of paragraph 4(b)(iii) above, “**Rights Issue**” means an offer of Share or issue of options, warrants or other securities giving the right to subscribe for the Shares open for a period fixed by the Directors to the Shareholders whose names appear on the register of members of our Company (and, where appropriate, to holders of other securities of our Company entitled to the offer) on a fixed record date in proportion to their then holdings of such Shares (or, where appropriate, such other securities) (subject in all cases to such exclusions or other arrangements as the Directors may consider necessary, desirable or expedient (but in compliance with the relevant Listing Rules) in relation to fractional entitlements or having regard to any restrictions or obligations under the laws of, or the requirements of any recognised regulatory body or any stock exchange in, any territory applicable to our Company);

each of the general mandates referred to in paragraphs 4(a)(iii) and 4(a)(iv) above would remain in effect until the earliest of (A) the conclusion of our Company’s next annual general meeting; (B) the expiration of the period within which our Company’s next annual general meeting as required by the Companies Act, the Bye-Laws or any applicable laws of Bermuda to be held; and (C) when varied or revoked by an ordinary resolution of the Shareholders in general meeting;

- (b) the appointment of the Directors was approved, confirmed and ratified;
- (c) the Bye-Laws were approved and adopted conditional upon fulfillment of the Conditions and with effect from the Listing Date; and
- (d) the Listing and the Global Offering were approved.

5. Reorganisation

The companies comprising our Group did not undergo reorganisation in preparation for the Listing.

6. Repurchase of our Company’s own securities

This paragraph includes information relating to the repurchase of Shares, including information required by the Hong Kong Stock Exchange to be included in this prospectus concerning such repurchase.

(a) Relevant legal and regulatory requirements

The Listing Rules permit the Shareholders to grant to the Directors the general mandate to repurchase Shares which are listed on the Hong Kong Stock Exchange. The general mandate to repurchase Shares is required to be given by way of an ordinary resolution passed by the Shareholders in general meeting.

(b) Shareholders' approval

All proposed repurchases of Shares (which must be fully paid up) must be approved in advance by ordinary resolutions of the Shareholders in general meeting, either by way of general mandate or by specific approval of a particular transaction.

On December 15, 2017, the Directors were granted the general mandate to repurchase up to 10% of the aggregate par value of the Share in issue immediately following completion of the Global Offering on the Hong Kong Stock Exchange or on any other stock exchange on which our Company's securities may be listed and which was recognised by the SFC and the Hong Kong Stock Exchange for this purpose. The general mandate to repurchase Shares will expire at the earliest of (i) the conclusion of our Company's next annual general meeting; (ii) the expiration of the period within which our Company's next annual general meeting is required by the Companies Act, the Bye-Laws or any applicable laws of Bermuda to be held; or (iii) when varied or revoked by an ordinary resolution of the Shareholders in general meeting (the "**Relevant Period**").

(c) Source of funds

Repurchase of Shares listed on the Hong Kong Stock Exchange must be funded out of funds legally available for the purpose in accordance with the Memorandum, the Bye-Laws and the applicable laws of Bermuda. Our Company may not repurchase Shares on the Hong Kong Stock Exchange for consideration other than cash or for settlement otherwise than in accordance with the Listing Rules. Subject to the foregoing, any repurchase of Shares by our Company must be made out of the capital paid up on the repurchased Shares or out of the funds of our Company which would otherwise be available for dividend or distribution or out of the proceeds of a fresh issue of Shares made for the purpose of the repurchase. Any premium payable on a repurchase over the par value of the Shares to be repurchased must be provided for out of funds of our Company which would otherwise be available for dividend or distribution or out of our Company's share premium account before the Shares are repurchased.

(d) Reasons for repurchases

The Directors believe that it is in the best interests of our Company and the Shareholders as a whole for the Directors to have general authority to execute repurchases of Shares in the market. The repurchases may, depending on market conditions and funding arrangements at the time, lead to an enhancement of the net assets per Share and/or earnings per Share and will only be made where the Directors believe that the repurchases will benefit our Company and the Shareholders.

(e) Funding of repurchases

In repurchasing securities, our Company may only apply funds legally available for such purpose in accordance with the Memorandum, the Bye-Laws, the Listing Rules, the Companies Act and other applicable laws of Bermuda. On the basis of the current financial position of our Company as disclosed in this prospectus and taking into account the current working capital position of our Company, the Directors believe that, if the general mandate to repurchase Shares were to be exercised in full, it might have a material adverse effect on its working capital and/or the gearing position as compared with the position disclosed in this prospectus. However, the Directors do not propose to exercise the general mandate to repurchase Shares to such an extent as would, in the circumstances, have a material adverse effect on the working capital requirements of our Company or the gearing levels which in the opinion of the Directors are from time to time appropriate for our Company.

(f) Share capital

The exercise in full of the current general mandate to repurchase Shares, on the basis of 723,979,312 Shares in issue immediately following completion of the Global Offering (without taking into account any Shares which may be allotted and issued upon the exercise of the Over-allotment Option and the options which have been granted under the Pre-IPO Share Option Scheme or which may be granted under the Share Option Scheme), could accordingly result in up to 72,397,931 Shares being repurchased by our Company during the Relevant Period.

(g) General

None of the Directors nor, to the best of their knowledge having made all reasonable enquiries, any of their respective close associates currently intends to sell any Share to our Company.

The Directors have undertaken to the Hong Kong Stock Exchange that, so far as the same may be applicable, they shall exercise the general mandate to repurchase Shares in accordance with the Listing Rules and the laws of Bermuda.

If, as a result of any repurchase of the Shares, a Shareholder's proportionate interest in the voting rights is increased, the increase will be treated as an acquisition for the purpose of the Takeovers Code. Accordingly, a Shareholder or a group of Shareholders acting in concert could obtain or consolidate control of our Company and become obliged to make a mandatory offer in accordance with Rule 26 of the Takeovers Code. Save as aforesaid, the Directors are not aware of any consequences of repurchases which would arise under the Takeovers Code.

None of the core connected persons of our Company has notified our Company that he/she or it has a present intention to sell his or her or its Shares to our Company, or has undertaken not to do so, if the general mandate to repurchase Shares is exercised.

7. Further information about our subsidiaries in the PRC

Our Company has the following subsidiaries in the PRC, the basic information of which as of the Latest Practicable Date is set out below:

(a) CDCL

Nature:	Limited liability company
Date of incorporation:	October 19, 2011
Term of business operation:	From October 19, 2011 to October 19, 2021
Registered capital:	HK\$5,000,000
Attributable interest of our Group:	100%
Scope of business:	Wholesale, import and export of prepackaged food (excluding reheated food), milk tea machines, coffee machines, beverage machines, cookware and tableware (excluding any goods subject to the administration of state-run trade and with regard to goods subject to quota control, license management and other specific regulations, applications should be made in accordance with the relevant regulations of the state) and provision of relevant ancillary businesses; catering management, marketing planning, business information consultation; operating sales of warm, cold or hot milk tea and coffee (limited to operation by branches); and relevant ancillary businesses
Executive director:	Mr. Zhang Shengtian
Legal representative:	Mr. Zhang Shengtian

(b) CDTL

Nature:	Limited liability company
Date of incorporation:	July 26, 2012
Term of business operation:	From July 26, 2012 to July 26, 2022
Registered capital:	RMB5,000,000
Attributable interest of our Group:	100%
Scope of business:	Wholesale, import and export of frozen food, aquatic food, pre-packaged food (excluding reheated pre-packaged food) (excluding goods subject to the administration of state-run trade and with regard to goods subject to quota control, license management and other specific regulations, applications should be made in accordance with the relevant regulations of the state) and provision of relevant ancillary businesses
Executive director:	Mr. Zhang Shengtian
Legal representative:	Mr. Zhang Shengtian

(c) DGTW

Nature:	Limited liability company
Date of incorporation:	September 11, 2009
Term of business operation:	From September 11, 2009 to September 11, 2029
Registered capital:	HK\$78,880,000
Attributable interest of our Group:	100%
Scope of business:	Production and sales of solid beverages, roasted coffee, cocoa products and coffee cooking utensils, packaging and wholesale business of sugar; packaging, wholesale and import and export businesses of tea, products containing tea, tea substitutes (excluding goods subject to the administration of state-run trade and with regard to goods subject to quota control and license management, applications should be made in accordance with the relevant regulations of the state); self-owned plants leasing business (except restricted plants and with regard to plants subject to national specific regulations, application should be made in accordance with relevant regulations of the state); catering service (the above activities do not involve special management measures for foreign investment access)
Executive director:	Mr. Wong, Mr. Wu Kam On Keith and Mr. Leung Kim Ming
Legal representative:	Mr. Leung Kim Ming

(d) DG TWG Heritage

Nature:	Limited liability company
Date of incorporation:	January 7, 2014
Term of business operation:	From January 7, 2014 to January 7, 2034
Registered capital:	RMB13,500,000
Attributable interest of our Group:	100%
Scope of business:	Wholesale, import and export of tea packaging, solid beverages, roasted coffee, coffee cooking utensils and tea cooking utensils; commission agent (except auction) (excluding goods subject to the administration of state-run trade and with regard to goods subject to quota control, license management and specific regulations, applications should be made in accordance with relevant regulations)
Executive director:	Mr. Zhang Shengtian, Mr. Leung Kim Ming and Mr. Wu Kam On Keith
Legal representative:	Mr. Leung Kim Ming

(e) SHTW

Nature:	Limited liability company
Date of incorporation:	June 6, 2003
Term of business operation:	From June 6, 2003 to June 5, 2023
Registered capital:	US\$2,400,000
Attributable interest of our Group:	100%
Scope of business:	Pre-packaged food, frozen meat, aquatic food, eggs, dairy products (including infant milk powder), ingredients, condiments, food, beverages, tea, sugar (except for export), flavouring essence, edible oils, nuts, dried fruits, coffee and coffee cooking utensils and edible agricultural products (except cereals, beef, mutton and pork); Wholesale, commission agent (except auction) and import and export of food processing machinery and spare parts, electrical equipment and spare parts and tableware and provision of relevant ancillary businesses; Cafe (including retail sales of wine but limited to operation by branches) (excluding goods subject to the administration of state-run trade and with regard to goods subject to quota control, license management and specific regulations, applications should be made in accordance with relevant regulations of the state)
Executive director:	Mr. Leung Kim Ming
Legal representative:	Mr. Leung Kim Ming

B. FURTHER INFORMATION ABOUT THE BUSINESS OF OUR GROUP**1. Summary of material contracts**

The members of our Group have entered into the following contracts (not being contracts entered into in the ordinary course of business) within the two years immediately preceding the date of this prospectus which are or may be material:

- (a) the memorandum for sale and purchase dated May 30, 2016 entered into between our Company and Hero Ace, pursuant to which our Company transferred one ordinary share, being the entire issued share capital of Elect Gold to Hero Ace as more particularly set out in the section headed “History, Development and Corporate Structure — Material Development after Delisting — (b) Incorporation, Acquisitions and Disposal of Elect Gold” in this prospectus;
- (b) the memorandum for sale and purchase dated December 30, 2016 entered into between Heritage Teas (Private) Limited and TWCI, pursuant to which TWCI acquired 300,000 shares, representing 20% of the issued share capital, of HK TWG Heritage from Heritage Teas (Private) Limited as more particularly set out in the section headed “History, Development and Corporate Structure — History and Business Development — Material Development after Delisting — (e) Acquisition of HK TWG Heritage” in this prospectus;
- (c) the memorandum for sale and purchase dated December 30, 2016 entered into between Global Tea Trading and TWCI, pursuant to which TWCI acquired 435,000 shares, representing 29% of the issued share capitals of HK TWG Heritage, from Global Tea Trading as more particularly set out in the section headed “History, Development and Corporate Structure — History and Business Development — Material Development after Delisting — (e) Acquisition of HK TWG Heritage” in this prospectus;
- (d) the strategic cooperation agreement dated July 27, 2017 entered into between our Company and NH Foods, pursuant to which our Company and NH Foods will cooperate to develop business opportunities in Hong Kong, Macau and the PRC with regard to frozen, fresh, pre-cooked processed meat and seafood products as more particularly set out in the section headed “History, Development and Corporate Structure — History and Business Development — Material Development after Delisting — (g) Entering into Strategic Cooperation Agreement with NH Foods” in this prospectus;

- (e) the memorandum of understanding dated April 19, 2018 entered into between our Company and F&N, pursuant to which our Company and F&N will explore business and product development opportunities for the supply, distribution, co-branded promotion and co-development of beverage products and/or beverage solutions as more particularly set out in the section headed “History, Development and Corporate Structure — Material Development after Delisting — (h) Entering into Memorandum of Understanding with F&N” in this prospectus;
- (f) the Deed of Indemnity;
- (g) the Deed of Non-competition;
- (h) the Non-Compete Undertaking dated July 12, 2017 executed by Mr. Chu Sun Chi and Ms. Fan Yin Fun in favour of our Company (for itself and, where appropriate, on behalf of Whole Sun and other subsidiaries of our Group) regarding the non-competition undertakings as more particularly set out in the section headed “History, Development and Corporate Structure — Our Corporate Development — (a) Major subsidiaries of TWIC — Whole Sun” in this prospectus;
- (i) a cornerstone agreement dated November 17, 2017 entered into between our Company, NH Foods and the Sole Global Coordinator (the “**NH Foods Cornerstone Agreement**”), pursuant to which NH Foods agreed to subscribe for our Shares at the Offer Price in the amount of one billion Japanese Yen as further described in the section headed “Cornerstone Investors” in this prospectus;
- (j) a supplemental cornerstone agreement dated April 19, 2018 entered into between our Company, NH Foods and the Sole Global Coordination, pursuant to which the parties agreed to vary certain clauses of the NH Foods Cornerstone Agreement;
- (k) a cornerstone agreement dated April 20, 2018 entered into between our Company, F&N and the Joint Bookrunners, pursuant to which F&N agreed to subscribe for a fixed number of 32,000,000 Shares at the Offer Price as further described in the section headed “Cornerstone Investors” in this prospectus; and
- (l) the Hong Kong Underwriting Agreement.

2. Intellectual property rights

As of the Latest Practicable Date, we held 47 registered trademarks in Hong Kong and 91 in the PRC which were material to our business. We had 7 pending trademark applications and 3 trademark renewal applications in the PRC as of the Latest Practicable Date. In addition, we were the owner of 29 domain names as of the Latest Practicable Date. Please refer to Appendix VI to this prospectus for further details of our material intellectual property rights.

C. FURTHER INFORMATION ABOUT OUR DIRECTORS

1. Interests and/or short positions of our Directors and chief executive in our Shares or the shares of our associated corporation

Immediately following completion of the Global Offering (without taking into account any Shares which may be allotted and issued upon the exercise of the Over-allotment Option and the options which have been granted under the Pre-IPO Share Option Scheme or which may be granted under the Share Option Scheme), the interests and short positions of each Director and chief executive of our Company in our Shares, underlying shares and debentures of our Company or our associated corporation (within the meaning of Part XV of the SFO) which will have to be notified to our Company and the Hong Kong Stock Exchange pursuant to Divisions 7 and 8 of Part XV of the SFO (including interests and short positions which he/she is taken or deemed to have under such provisions of the SFO) once the Shares are listed, or will be required, pursuant to Section 352 of the SFO, to be entered in the register referred to therein, once the Shares are listed, or will be required, pursuant to the Model Code for Securities Transactions by Directors of Listed Issuers to be notified to our Company and the Hong Kong Stock Exchange once the Shares are listed, will be as follows:

(i) Long position in our Shares

Name of Director	Company concerned	Nature of interests	Class and number of securities held (Note 1)	Percentage of interests in the company concerned immediately upon completion of the Global Offering
Mr. Wong	Our Company	Interest in controlled corporation	484,779,312 ordinary Shares (L) (Note 2)	66.96%
Mr. Wu Kam On Keith	Our Company	Beneficial owner	1,376,000 Shares (L) (Note 3)	0.19%
Ms. Fan Yee Man	Our Company	Beneficial owner	918,000 Shares (L) (Note 4)	0.12%

Notes:

1. The letter “L” denotes the person’s long position in the securities.
2. These 484,779,312 Shares will be directly held by Hero Valour upon the completion of the Global Offering. As Mr. Wong is entitled to control Hero Valour, Mr. Wong is deemed to be interested in these 484,779,312 Shares under the SFO upon the Listing.
3. Mr. Wu Kam On Keith is interested in 1,376,000 Shares which may be allotted and issued to him upon full exercise of all options granted to him under the Pre-IPO Share Option Scheme.
4. Ms. Fan Yee Man is interested in 918,000 Shares which may be allotted and issued to her upon full exercise of all options granted to her under the Pre-IPO Share Option Scheme.

(ii) Long position in the shares of our associated corporation

Name of Director	Name of associated corporation	Nature of interest	Class and number of securities held	Percentage of interests in the associated corporation immediately upon completion of the Global Offering
Mr. Wong	Hero Valour	Beneficial owner	1 ordinary share	100.0%

2. Interests and/or short positions of the substantial shareholders in the shares of our Company and any other member of our Group

So far as our Directors are aware, immediately following the completion of the Global Offering (without taking into account any Share which may be allotted and issued upon the exercise of the Over-allotment Option and the options which have been granted under the Pre-IPO Share Option Scheme and may be granted under the Share Option Scheme), the interests and short positions of the following persons, not being a Director or chief executive of our Company, which will have to be disclosed to our Company under the provisions of Divisions 2 and 3 of Part XV of the SFO, or will be, directly or indirectly, interested in 10% or more of the issued voting shares of our Company or any other member of our Group, will be as follows:

Name of shareholder	Company concerned	Nature of interests	Class and number of securities held	Percentage of interests in the company concerned
Hero Valour (Note 1)	Our Company	Beneficial owner	484,779,312 ordinary Shares (L)	66.96%
Ms. Li Ying Wah Irene (Note 2)	Our Company	Interest of spouse	484,779,312 ordinary Shares (L)	66.96%

Name of shareholder	Company concerned	Nature of interests	Class and number of securities held	Percentage of interests in the company concerned
Mr. Chu Sun Chi (Note 3)	Whole Sun	Beneficial owner and interest of spouse	4,000 ordinary shares (L)	40.0%
Ms. Fan Yin Fun (Note 3)	Whole Sun	Beneficial owner and interest of spouse	4,000 ordinary shares (L)	40.0%

Note 1: Our Company will be owned as to approximately 66.96% by Hero Valour immediately upon completion of the Global Offering. Hero Valour is 100% legally and beneficially owned by Mr. Wong. Under the SFO, Mr. Wong is deemed to be interested in the same number of Shares held by Hero Valour. Mr. Wong is the sole director of Hero Valour.

Note 2: Ms. Li Ying Wah Irene is the spouse of Mr. Wong. Under the SFO, Ms. Li is deemed to be interested in the same number of Shares in which Mr. Wong is interested.

Note 3: Each of Mr. Chu Sun Chi and Ms. Fan Yin Fun, being spouse of Mr. Chu Sun Chi, has interest in 2,000 ordinary shares of Whole Sun. Under the SFO, Mr. Chu is deemed to be interested in the same number of shares of Whole Sun in which Ms. Fan Yin Fun is interested, and vice versa.

3. Particulars of service agreements and appointment letters

(a) Executive Directors

Each of the executive Directors has entered into a service agreement with our Company under which he/she has agreed to act as an executive Director for an initial term of three years commencing from the Listing Date. Either party has the right to give not less than three months' written notice to terminate the service agreement or otherwise in accordance with the terms of the service agreement.

Each of the executive Directors is entitled to a monthly salary and discretionary bonus. The aggregate annual salary (excluding discretionary bonus) of the executive Directors is approximately HK\$10.2 million.

(b) Independent non-executive Directors

Each of the independent non-executive Directors has entered into an appointment letter with our Company under which he has agreed to act as an independent non-executive Director for an initial term of three years commencing from the Listing Date. The aggregate annual fees payable to the independent non-executive Directors is HK\$0.9 million.

(c) Remuneration of the Directors

- (i) The aggregate of the remuneration paid and benefits in kind granted to our Directors by any member of our Group in respect of the financial year ended December 31, 2017 is approximately HK\$8.5 million.
- (ii) The aggregate remuneration (excluding discretionary bonus) payable to, and benefits in kind receivable by, our Directors by any member of our Group in respect of the financial year ending December 31, 2018 under the arrangements in force at the date of this prospectus are estimated to be approximately HK\$10.8 million.

Save as disclosed above, none of our Directors has entered into, or has proposed to enter into a service agreement with any member of our Group (other than contracts expiring or determinable by the employer within one year without the payment of compensation (other than statutory compensation)).

D. SHARE OPTION SCHEMES

1. Pre-IPO Share Option Scheme

Summary of terms

The following is a summary of the principal terms of the rules of the Pre-IPO Share Option Scheme conditionally adopted by the written resolutions of the then sole Shareholder passed on December 15, 2017:

(a) Purpose of the Pre-IPO Share Option Scheme

The purpose of the Pre-IPO Share Option Scheme is to recognise the contribution to our Group by executive Directors and certain employees of the members of our Group. The Pre-IPO Share Option Scheme will give the participants an opportunity to have a personal stake in our Company and will help to motivate the participants to optimise their performance and efficiency and to attract and retain the participants whose contributions are important to the long-term growth and profitability of our Group.

(b) Who may join and basis of eligibility

The Board may, at its absolute discretion, invite any full-time or part-time employees of any members of our Group and any executive Directors of our Company, to be a participant of the Pre-IPO Share Option Scheme and to take up an option to subscribe for Shares.

The basis of eligibility of any participant to the grant of any option shall be determined by the Board from time to time on the basis of the participant's contribution or potential contribution to the development and growth of our Group.

(c) Price of Shares

The subscription price for the Shares under the Pre-IPO Share Option Scheme equals to 30% of the Offer Price (to be rounded up to the nearest dollar, where necessary).

(d) Grant of options and acceptance of offers

Subject to the terms of the Pre-IPO Share Option Scheme, the Board shall be entitled at any time immediately before the Latest Practicable Date to make an offer to any participant as the Board may in its absolute discretion select, and subject to such conditions as the Board may think fit, which may include a condition that the grantees shall not dispose of the Shares issued upon exercise of the option within such period of time or under such conditions as the Board may at its absolute discretion determine, minimum period for which an option must be held and performance targets that must be achieved before an option can be exercised, to subscribe during the period for the exercise of an option commencing on the Listing Date and ending on the day immediately before the tenth anniversary of the Listing Date (the “**Pre-IPO Option Period**”) for such number of Shares as the Board may determine at the subscription price.

An offer shall be made to a participant on a business day in writing in such form as the Board may from time to time determine, requiring the participant to undertake to hold the option on the terms on which it is to be granted and to be bound by the provisions of the Pre-IPO Share Option Scheme. The offer must be accepted on the offer date.

The amount payable by the grantee of an option to our Company on acceptance of the offer for the grant of an option is HK\$1.00.

(e) Maximum number of Shares available for subscription

The maximum number of Shares subject to the Pre-IPO Share Option Scheme is 9,000,000, representing approximately 1.24% of the total issued Shares immediately upon completion of the Global Offering (without taking into account any Shares which may be allotted and issued upon the exercise of the Over-allotment Option and the options which have been granted under the Pre-IPO Share Option Scheme or which may be granted under the Share Option Scheme).

(f) Exercise of option

An option may be exercised in accordance with the terms of the Pre-IPO Share Option Scheme at any time during the Pre-IPO Option Period subject to the provisions of early termination thereof.

All the options under the Pre-IPO Share Option Scheme were granted immediately before the Latest Practicable Date and no further options will be granted under the Pre-IPO Share Option Scheme prior to the Listing Date. Subject to the following vesting periods, any option granted under the Pre-IPO Share Option Scheme will be exercisable commencing on the day falling on the Listing Date and ending on the day immediately before the tenth anniversary of the Listing Date. All holders of options granted under the Pre-IPO Share Option Scheme may only exercise their options in the following manner:

Maximum number of Shares under the option exercisable	Period for exercise of the relevant option
30% of the options granted	at any time on or after the Listing Date to the date immediately before the first anniversary of the Listing Date
30% of the options granted	at any time on or after the date falling on the first anniversary of the Listing Date to the date immediately before the second anniversary of the Listing Date
40% of the options granted	at any time on or after the date falling on the second anniversary of the Listing Date to the date immediately before the third anniversary of the Listing Date

All the options granted under the Pre-IPO Share Option Scheme will not be exercisable prior to the Listing Date.

(g) Rights are personal to grantee

An option shall not be transferable or assignable and no grantee shall in any way sell, transfer, charge, mortgage, encumber or create any interest (legal or beneficial) in favour of any third party over or in relation to any option. Any breach of the foregoing by a grantee shall entitle our Company to cancel, revoke or terminate any option granted to such grantee to the extent not already exercised.

(h) Rights on cessation of employment by death

In the event of the death of the grantee (provided that none of the events which would be a ground for termination of employment referred to in (i) below arises within a period of three years prior to the death, in the case the grantee is an employee at the date of grant), the legal personal representative(s) of the grantee may exercise the option up to the grantee's entitlement (to the extent which has become exercisable and not already exercised) within a period of 12 months following his death provided that where any of the events referred to in (k), (l) and (m) below occurs prior to his death or within such period of 12 months following his death, then his legal personal representative(s) may so exercise the option within such of the various periods respectively set out therein.

(i) Rights on cessation of employment by dismissal

In the event that the grantee subsequently ceases to be an employee of our Group on any one or more of the grounds that he has been guilty of serious misconduct, or has committed an act of bankruptcy or has become insolvent or has made any arrangement or composition with his creditors generally, or has been convicted of any criminal offence involving his integrity or honesty or (if so determined by the Board) on any other ground on which an employer would be entitled to terminate his employment at common law or pursuant to any applicable laws or under the grantee's service contract with our Group, his option shall lapse automatically (to the extent not already exercised) on the date of cessation of his employment with our Group.

(j) Rights on cessation of employment for other reasons

In the event that the grantee subsequently ceases to be an employee of our Group for any reason other than his death or the termination of his employment of an employee on one or more of the grounds specified in (i) above, the option (to the extent not already lapsed or exercised) shall lapse on the date of resignation.

(k) Rights on a general offer

In the event of a general offer (whether by way of takeover offer or scheme of arrangement or otherwise in like manner) being made to all the Shareholders (or all such holders other than the offeror and/or any persons controlled by the offeror and/or any person acting in association or concert with the offeror) and such offer becoming or being declared unconditional, the grantee (or, as the case may be, his legal personal representative(s)) shall be entitled to exercise the option in full (to the extent not already lapsed or exercised) at any time within one month after the date on which the offer becomes or is declared unconditional.

(l) Rights on winding-up

In the event a notice is given by our Company to the members to convene a general meeting for the purposes of considering, and if thought fit, approving a resolution to voluntarily wind-up our Company, our Company shall on the same date as or soon after it despatches such notice to each member of our Company give notice thereof to all grantees and thereupon, each grantee (or, as the case may be, his legal personal representative(s)) shall be entitled to exercise all or any of his options at any time not later than two business days prior to the proposed general meeting of our Company by giving notice in writing to our Company, accompanied by a remittance for the full amount of the aggregate subscription price for the Shares in respect of which the notice is given whereupon our Company shall as soon as possible and, in any event, no later than the business day immediately prior to the date of the proposed general meeting referred to above, allot the relevant Shares to the grantee credited as fully paid.

(m) Rights on compromise, arrangement, amalgamation or merger

In the event of a compromise or arrangement between our Company and the Shareholders or the creditors of our Company being proposed in connection with a scheme for the reconstruction of our Company, or an amalgamation or a merger involving our Company and any other company or companies pursuant to the Companies Act, our Company shall give notice thereof to all the grantees (or, as the case may be, their legal personal representatives) on the same day as it gives notice of the meeting to the Shareholders or the creditors to consider such a compromise or arrangement, and the options (to the extent not already lapsed or exercised) shall become exercisable in whole or in part on such date not later than two business days prior to the date of the general meeting of our Company directed to be convened by the court for the purposes of considering such compromise or arrangement, or the date of the general meeting of our Company to be convened for the purposes of considering the amalgamation or the merger, as applicable (“**Suspension Date**”), by giving notice in writing to our Company accompanied by a remittance for the full amount of the aggregate subscription price for the Shares in respect of which the notice is given whereupon our Company shall as soon as practicable and, in any event, no later than 3:00 p.m. on the business day immediately prior to the date of the proposed general meeting, allot and issue the relevant Shares to the grantee credited as fully paid. If the resolution(s) approving such a compromise, arrangement, amalgamation or merger is/are passed at such proposed general meeting with effect from the Suspension Date, the rights of all grantees to exercise their respective options shall forthwith be suspended. Upon such compromise, arrangement, amalgamation or merger becoming effective, all options shall, to the extent that they have not been exercised, lapse. The Board shall endeavor to procure that the Shares issued as a result of the exercise of options hereunder shall for the purposes of such compromise or

arrangement form part of the issued share capital of our Company on the effective date thereof and that such Shares shall in all respects be subject to such compromise or arrangement. For a compromise or arrangement, if for any reason such compromise or arrangement is not approved by the court (whether upon the terms presented to the court or upon any other terms as may be approved by such court), the rights of grantees to exercise their respective options shall with effect from the date of the making of the order by the court be restored in full but only up to the extent not already exercised and shall thereupon become exercisable (but subject to the other terms of the Pre-IPO Share Option Scheme) as if such compromise or arrangement had not been proposed by our Company and no claim shall lie against our Company or any of its officers for any loss or damage sustained by any grantee as a result of such proposal, unless any such loss or damage shall have been caused by the act, neglect, fraud or wilful default on the part of our Company or any of the officers.

(n) Lapse of options

An option shall lapse automatically and not be exercisable (to the extent not already exercised) on the earliest of:

- (i) the expiry of the period referred to in paragraph (f) above;
- (ii) the expiry of the relevant period or the occurrence of the relevant event referred to in paragraphs (h), (i), (j), (k), (l) or (m) above;
- (iii) subject to paragraph (l) above, the date of the commencement of the winding-up of our Company;
- (iv) in the event that the grantee is an employee of our Group when an offer is made to him and he subsequently ceases to be an employee of our Group on any one or more of the grounds that he has been guilty of serious misconduct, or has committed an act of bankruptcy or has become insolvent or has made any arrangement or composition with his creditors generally, or has been convicted of any criminal offence involving his integrity or honesty or (if so determined by the Board) on any other ground on which an employer would be entitled to terminate his employment at common law or pursuant to any applicable laws or under the grantee's service contract with our Group, the date of cessation of his employment with our Group. A resolution of the Board or the board of directors of the relevant member of our Group to the effect that employment of a grantee has or has not been terminated on one or more of the grounds specified in this paragraph (iv) shall be conclusive and binding on the grantee;

- (v) the occurrence of any act of bankruptcy, insolvency or entering into of any arrangements or compositions with his creditors generally by the grantee, or conviction of the grantee of any criminal offence involving his integrity or honesty;
- (vi) the date on which the Board exercises our Company's right to cancel, revoke or terminate the option on the ground that the grantee commits a breach of paragraph (g) in respect of that or any other option; or
- (vii) subject to the compromise or arrangement as referred to in paragraph (m) becoming effective, the date on which such compromise or arrangement becomes effective.

(o) Cancellation of options granted but not yet exercised

Any cancellation of options granted but not exercised may be effected on such terms as may be agreed with the relevant grantee, as the Board may in its absolute discretion see fit and in manner that complies with all applicable legal requirements for such cancellation.

(p) Alteration to the Pre-IPO Share Option Scheme

- (i) The Pre-IPO Share Option Scheme may be altered in any respect by resolution of the Board except that the provisions of paragraphs (a) to (p) shall not be altered to the advantage of grantees or prospective grantees except with the prior sanction of the Shareholders by a resolution in general meeting, provided that no such alteration shall operate to affect adversely the terms of issue of any option granted or agreed to be granted prior to such alteration except with the consent or sanction of such majority of the grantees as would be required of the Shareholders under the Bye-Laws for a variation of the rights attached to the Shares.
- (ii) Any alterations to the terms and conditions of the Pre-IPO Share Option Scheme, which are of a material nature, or any change to the terms of option granted, or any change to the authority of the Board in respect of alteration of the Pre-IPO Share Option Scheme, must be approved by the Shareholders in general meeting, except where the alterations take effect automatically under the existing terms of the Pre-IPO Share Option Scheme.

(q) Termination to the Pre-IPO Share Option Scheme

Our Company by resolution in general meeting or the Board may at any time terminate the operation of the Pre-IPO Share Option Scheme and in such event options granted prior to such termination shall continue to be valid and exercisable in accordance with provisions of the Pre-IPO Share Option Scheme.

(r) Conditions of the Pre-IPO Share Option Scheme

The Pre-IPO Share Option Scheme is conditional upon the Hong Kong Stock Exchange granting the listing of, and permission to deal in, the Shares which may be issued pursuant to the exercise of any options which may be granted under the Pre-IPO Share Option Scheme and commencement of dealings in the Shares on the Hong Kong Stock Exchange.

Outstanding options granted under the Pre-IPO Share Option Scheme

Options to subscribe for an aggregate of 9,000,000 Shares (representing approximately 1.24% of the total issued share capital of our Company immediately upon completion of the Global Offering (without taking into account any Shares which may be allotted and issued upon the exercise of the Over-allotment Option and the options which have been granted under the Pre-IPO Share Option Scheme or which may be granted under the Share Option Scheme) have been conditionally granted by our Company under the Pre-IPO Share Option Scheme for a consideration HK\$1.00 per grant.

APPENDIX IV

STATUTORY AND GENERAL INFORMATION

Particulars of the options conditionally granted under the Pre-IPO Share Option Scheme are set out below:

Name and position of grantee in our Group	Residential address	Number of Shares subject to the option	Percentage of issued share capital of our Company immediately after completion of the Global Offering (without taking into account any Shares which may be allotted and issued upon the exercise of the Over-allotment Option and the options which have been granted under the Pre-IPO Share Option Scheme or may be granted under the Share Option Scheme)
Mr. Wu Kam On Keith (Executive Director, group chief operation officer, company secretary)	Flat D, 6th Floor, Tower 18, Mayfair By The Sea I 23 Fo Chun Road, Tai Po, New Territories, Hong Kong	1,376,000	0.19%
Ms. Fan Yee Man (Executive Director, group chief financial officer)	Room 1413, Lung Chu House, Lung Poon Court Diamond Hill, Kowloon, Hong Kong	918,000	0.12%
Mr. Hui Chi Ho (Operating officer of group marketing and sales)	Flat A, 24th Floor, Block 26, South Horizons Ap Li Chau, Hong Kong	230,000	0.03%
Mr. Leung Kim Ming (Chief operating officer of China)	2th Floor, Block 7, Greenville Park, 178B Shek Po Tsuen Yuen Long, New Territories, Hong Kong	230,000	0.03%
Mr. Kam Chun Pong Bernard (Group business director)	Flat 4B, Tower 2, Hillsborough Court, 18 Old Peak Road Hong Kong	184,000	0.03%
Mr. Chan Pei Shun (Director of risk management and operation control)	Flat E, 35th Floor, Block 5, Phase 6, Maywood Court Kingswood Villas, 9 Tin Lung Road, Tin Shui Wai New Territories, Hong Kong	184,000	0.03%
Ms. Law Wan Yee Sandy (Internal audit manager)	Flat C, 1st Floor, Block 2, Phoenix Court, 39 Kennedy Road Wanchai, Hong Kong	230,000	0.03%
Mr. Zhang Shengtian (Director and legal representative of CDCL and CDTL and director of DG TWG Heritage)	Room 604, Unit 1, Block 6, 1 Jida Road Xiangzhou District, Zhuhai City, Guangzhou Province PRC	92,000	0.01%
Mr. Yeung Yuk Ming (The son-in-law of Mr. Chu Sun Chi, the director of Whole Sun)	1/F, No. 5, Pine Path, Kak Tin Village Shatin, New Territories, Hong Kong	346,000	0.05%
Other Grantees (152 employees of our Group)	N/A	5,210,000	0.72%
Total		9,000,000	1.24%

Save as disclosed above, no other options have been granted or agreed to be granted by our Company under the Pre-IPO Share Option Scheme as at the date of this prospectus.

Dilution impact of the Pre-IPO Share Option Scheme would not materially affect the shareholding structure as the maximum number of Shares which may be issued and allotted upon exercise of all options granted under the Pre-IPO Share Option Scheme shall be 9,000,000 Shares, representing approximately 1.24% of the total issued share capital of our Company immediately upon completion of the Global Offering (without taking into account any Shares which may be issued and allotted upon the exercise of the Over-allotment Option and the options which have been granted under the Pre-IPO Share Option Scheme or which may be granted under the Share Option Scheme). Assuming all the options granted under the Pre-IPO Share Option Scheme were exercised on the Listing Date, the shareholding of our Shareholders immediately following the Listing would be diluted by approximately 1.21% as calculated based on 732,979,312 Shares then in issue (without taking into account any Shares which may be issued upon exercise of the Over-allotment Option or any options which may be granted under the Share Option Scheme) and assuming our Company had been listed on the Hong Kong Stock Exchange since January 1, 2017 with 732,979,312 Shares in issue and all the options granted under the Pre-IPO Share Option Scheme were exercised on January 1, 2017, the dilution effect on our earnings per Share attributable to owners of the parent on a pro forma basis would be approximately 1.21% for the year ended December 31, 2017, which is considered to be immaterial.

2. Share Option Scheme

Summary of terms

The following is a summary of the principal terms of the rules of the Share Option Scheme conditionally adopted by the written resolutions of the then sole Shareholder passed on December 15, 2017 (the “**Adoption Date**”):

(a) Purpose of the Share Option Scheme

The purpose of the Share Option Scheme is to attract and retain the best available personnel, to provide additional incentive to employees (full-time and part-time), directors, consultants, advisers, substantial shareholders, distributors, contractors, suppliers, agents, customers, business partners or service providers of our Group and to promote the success of the business of our Group.

(b) Who may join and basis of eligibility

The Board may, at its absolute discretion and on such terms as it may think fit, grant any employee (full-time or part-time), director, consultant, adviser, substantial shareholder, distributor, contractor, supplier, agent, customer, business partner or service provider of any member of our Group, options to subscribe at a price calculated in accordance with paragraph (c) below for such number of Shares as it may determine in accordance with the terms of the Share Option Scheme.

The basis of eligibility of any participant to the grant of any option shall be determined by the Board (or as the case may be, the independent non-executive Directors) from time to time on the basis of his contribution or potential contribution to the development and growth of our Group.

(c) Price of Shares

The subscription price of a Share in respect of any particular option granted under the Share Option Scheme shall be a price solely determined by the Board and notified to a participant and shall be at least the higher of: (i) the closing price of the Shares as stated in the Hong Kong Stock Exchange's daily quotations sheet on the date of grant of the option, which must be a business day; (ii) the average of the closing prices of the Shares as stated in the Hong Kong Stock Exchange's daily quotations sheets for the five business days immediately preceding the date of grant of the option; and (iii) the nominal value of a Share on the date of grant of the option.

For the purpose of calculating the subscription price, where our Company has been listed on the Hong Kong Stock Exchange for less than five business days, the issue price of the Shares on the Hong Kong Stock Exchange shall be used as the closing price for any business day fall within the period before listing.

(d) Grant of options and acceptance of offers

An offer for the grant of options must be accepted within seven days inclusive of the day on which such offer was made. The amount payable by the grantee of an option to our Company on acceptance of the offer for the grant of an option is HK\$1.00.

(e) *Maximum number of Shares*

- (i) Subject to sub-paragraphs (ii) and (iii) below, the maximum number of Shares issuable upon exercise of all options to be granted under the Share Option Scheme and any other share option schemes of our Company as from the Adoption Date (excluding, for this purpose, Shares issuable upon exercise of options which have been granted but have lapsed in accordance with the terms of the Share Option Scheme or any other share option schemes of our Company) must not in aggregate exceed 10% of all the Shares in issue as at the Listing Date. Therefore, it is expected that our Company may grant options in respect of up to 72,397,931 Shares (or such numbers of Shares as shall result from a sub-division or a consolidation of such 72,397,931 Shares from time to time) to the participants under the Share Option Scheme.
- (ii) The 10% limit as mentioned above may be refreshed at any time by approval of the Shareholders in general meeting provided that the total number of Shares which may be issued upon exercise of all options to be granted under the Share Option Scheme and any other share option schemes of our Company must not exceed 10% of the Shares in issue as at the date of approval of the refreshed limit. Options previously granted under the Share Option Scheme and any other share option schemes of our Company (including those outstanding, cancelled or lapsed in accordance with the terms of the Share Option Scheme and any other share option schemes of our Company) will not be counted for the purpose of calculating the refreshed 10% limit. A circular must be sent to the Shareholders containing the information as required under the Listing Rules in this regard.
- (iii) Our Company may seek separate approval from the Shareholders in general meeting for granting options beyond the 10% limit provided the options in excess of the 10% limit are granted only to grantees specifically identified by our Company before such approval is sought. In such event, our Company must send a circular to the Shareholders containing a generic description of such grantees, the number and terms of such options to be granted and the purpose of granting options to them with an explanation as to how the terms of the options will serve such purpose and all other information required under the Listing Rules.

- (iv) The aggregate number of Shares which may be issued upon exercise of all outstanding options granted and yet to be exercised under the Share Option Scheme and any other share option schemes of our Company must not exceed 30% of the Shares in issue from time to time. No options may be granted under the Share Option Scheme or any other share option schemes of our Company if this will result in such 30% limit being exceeded.
- (v) The exercise of any option(s) shall be subject to our Shareholders in general meeting approving any increase in the authorized share capital of our Company. Subject thereto, our Board shall make available sufficient authorized but unissued share capital of our Company for purpose of allotment of Shares upon exercise of options.

(f) Maximum entitlement of each participant

The total number of Shares issued and to be issued upon exercise of options granted to any participant (including both exercised and outstanding options) under the Share Option Scheme or any other share option schemes of our Company in any 12-month period up to the date of grant shall not exceed 1% of the Shares in issue. Any further grant of options in excess of such limit must be separately approved by Shareholders in general meeting with such grantee and his close associates abstaining from voting. In such event, our Company must send a circular to the Shareholders containing the identity of the grantee, the number and terms of the options to be granted (and options previously granted to such grantee), and all other information required under the Listing Rules. The number and terms (including the subscription price) of the options to be granted must be fixed before the approval of the Shareholders and the date of the Board meeting proposing such further grant should be taken as the date of grant for the purpose of calculating the subscription price.

(g) Grant of options to certain connected persons

- (i) Any grant of an option to a Director, chief executive or substantial shareholder of our Company (or any of their respective associates) must be approved by the independent non-executive Directors (excluding any independent non-executive Director who is the grantee of the option).

(ii) Where any grant of options to a substantial Shareholder or an independent non-executive Director (or any of their respective associates) will result in the total number of Shares issued and to be issued upon exercise of all options already granted and to be granted (including options exercised, cancelled and outstanding) to such person under the Share Option Scheme and any other share option schemes of our Company in any 12-month period up to and including the date of such grant:

(a) representing in aggregate over 0.1% of the Shares in issue; and

(b) having an aggregate value, based on the closing price of the Shares at the date of each grant, in excess of HK\$5 million,

such further grant of options is required to be approved by the Shareholders at a general meeting of our Company, with voting to be taken by way of poll. Our Company shall send a circular to the Shareholders containing all information as required under the Listing Rules in this regard. The grantee, his associates and all core connected persons of our Company shall abstain from voting in favour at such general meeting (except where any such person intends to vote against the proposed grant and his intention to do so has been stated in the aforesaid circular). Any change in the terms of an option granted to a substantial Shareholder or an independent non-executive Director or any of their respective associates is also required to be approved by the Shareholders in the aforesaid manner.

(h) Restrictions on the time of grant of options

(i) Our Company may not grant any options after inside information has come to its knowledge until such inside information has been announced. In particular, no options may be granted during the period commencing one month immediately before the earlier of:

(a) the date of the Board meeting (as such date is first notified to the Hong Kong Stock Exchange in accordance with the Listing Rules) for the approval of our Company's results for any year, half-year or other interim period (whether or not required under the Listing Rules); and

(b) the deadline on which our Company shall publish an announcement of the results for any year or half-year period under the Listing Rules, or other interim period (whether or not required under the Listing Rules),

and ending on the date of the results announcement.

- (ii) Further to the restrictions in paragraph (i) above, no option may be granted to a Director on any day on which financial results of our Company are published and:
 - (a) during the period of 60 days immediately preceding the publication date of the annual results or, if shorter, the period from the end of the relevant financial year up to the publication date of the results; and
 - (b) during the period of 30 days immediately preceding the publication date of the half-year results or, if shorter, the period from the end of the relevant half-year period up to the publication date of the results.

(i) Time of exercise of option

An option may be exercised in accordance with the terms of the Share Option Scheme at any time during a period as the Board may determine which shall not exceed ten years from the date of grant subject to the provisions of early termination thereof.

(j) Performance targets

Save as determined by the Board and provided in the offer of the grant of the relevant options, there is no performance target which must be achieved before any of the options can be exercised.

(k) Ranking of Shares

The Shares to be allotted upon the exercise of an option will be subject to all the provisions of the Bye-Laws for the time being in force and will rank *pari passu* in all respects with the fully paid Shares in issue on the date of allotment and accordingly will entitle the holders to participate in all dividends or other distributions paid or made after the date of allotment other than any dividend or other distribution previously declared or recommended or resolved to be paid or made with respect to a record date which shall be on or before the date of allotment, save that the Shares allotted upon the exercise of any option shall not carry any voting rights until the name of the grantee has been duly entered on the register of members of our Company as the holder thereof.

(l) Rights are personal to grantee

An option shall not be transferable or assignable and shall be personal to the grantee of the option.

(m) Rights on cessation of employment by death

In the event of the death of the grantee (provided that none of the events which would be a ground for termination of employment referred to in (n) below arises within a period of three years prior to the death, in the case the grantee is an employee at the date of grant), the legal personal representative(s) of the grantee may exercise the option up to the grantee's entitlement (to the extent which has become exercisable and not already exercised) within a period of 12 months following his death provided that where any of the events referred to in (q), (r) and (s) below occurs prior to his death or within such period of 12 months following his death, then his legal personal representative(s) may so exercise the option within such of the various periods respectively set out therein.

(n) Rights on cessation of employment by dismissal

In the event that the grantee is an employee of our Group at the date of grant and he subsequently ceases to be an employee of our Group on any one or more of the grounds that he has been guilty of serious misconduct, or has committed an act of bankruptcy or has become insolvent or has made any arrangement or composition with his or her creditors generally, or has been convicted of any criminal offence involving his integrity or honesty or (if so determined by the Board) on any other ground on which an employer would be entitled to terminate his employment at common law or pursuant to any applicable laws or under the grantee's service contract with our Group, his option shall lapse automatically (to the extent not already exercised) on the date of cessation of his employment with our Group.

(o) Rights on cessation of employment or engagement for other reasons

In the event that the grantee is an employee, a consultant or an adviser (as the case may be) of a member of our Group at the date of grant and he subsequently ceases to be an employee, a consultant or an adviser (as the case may be) of our Group for any reason other than his death or the termination of his employment of an employee or engagement of a consultant or an adviser (as the case may be) on one or more of the grounds specified in (n) above, the option (to the extent not already lapsed or exercised) shall lapse on the date of resignation (in the case of employee) or the date of cessation of such engagement of a consultant or an adviser (as the case may be) (which date will be the last actual day of providing consultancy or advisory services to the relevant member of our Group).

(p) Effects of alterations to share capital

In the event of any alteration in the capital structure of our Company whilst any option remains exercisable, whether by way of capitalisation of profits or reserves, rights issue, open offer, consolidation, subdivision or reduction of the share capital of our Company (other than an issue of Shares

as consideration in respect of a transaction to which any member of our Group is a party), such corresponding adjustments (if any) shall be made in the number of Shares subject to the option so far as unexercised; and/or the subscription prices, as the auditors of or independent financial adviser to our Company shall certify or confirm in writing (as the case may be) to the Board to be in their opinion fair and reasonable in compliance with the relevant provisions of the Listing Rules, or any guideline or supplemental guideline issued by the Hong Kong Stock Exchange from time to time, provided that any alteration shall give a grantee, as near as possible, the same proportion of the issued share capital of our Company as that to which he was previously entitled, but no adjustment shall be made to the effect of which would be to enable a Share to be issued at less than its nominal value.

(q) Rights on a general offer

In the event of a general offer (whether by way of takeover offer or scheme of arrangement or otherwise in like manner) being made to all the Shareholders (or all such holders other than the offeror and/or any persons controlled by the offeror and/or any person acting in association or concert with the offeror) and such offer becoming or being declared unconditional, the grantee (or, as the case may be, his legal personal representative(s)) shall be entitled to exercise the option in full (to the extent not already lapsed or exercised) at any time within one month after the date on which the offer becomes or is declared unconditional.

(r) Rights on winding-up

In the event a notice is given by our Company to the members to convene a general meeting for the purposes of considering, and if thought fit, approving a resolution to voluntarily wind-up our Company, our Company shall on the same date as or soon after it despatches such notice to each member of our Company give notice thereof to all grantees and thereupon, each grantee (or, as the case may be, his legal personal representative(s)) shall be entitled to exercise all or any of his options at any time not later than two business days prior to the proposed general meeting of our Company by giving notice in writing to our Company, accompanied by a remittance for the full amount of the aggregate subscription price for the Shares in respect of which the notice is given whereupon our Company shall as soon as possible and, in any event, no later than the business day immediately prior to the date of the proposed general meeting referred to above, allot the relevant Shares to the grantee credited as fully paid.

(s) Rights on compromise, arrangement, amalgamation or merger

In the event of a compromise or arrangement between our Company and the Shareholders or the creditors of our Company being proposed in connection with a scheme for the reconstruction of our Company, or an amalgamation or a merger involving our Company and any other company or companies pursuant to the Companies Act, our Company shall give notice thereof to all the grantees (or, as the case may be, their legal personal representatives) on the same day as it gives notice of the meeting to the Shareholders or the creditors to consider such a compromise or arrangement, and the options (to the extent not already lapsed or exercised) shall become exercisable in whole or in part on such date not later than two business days prior to the date of the general meeting of our Company directed to be convened by the court for the purposes of considering such compromise or arrangement, or the date of the general meeting of our Company to be convened for the purposes of considering the amalgamation or the merger, as applicable (“**Suspension Date**”), by giving notice in writing to our Company accompanied by a remittance for the full amount of the aggregate subscription price for the Shares in respect of which the notice is given whereupon our Company shall as soon as practicable and, in any event, no later than 3:00 p.m. on the business day immediately prior to the date of the proposed general meeting, allot and issue the relevant Shares to the grantee credited as fully paid. If the resolution(s) approving such a compromise, arrangement, amalgamation or merger is/are passed at such proposed general meeting with effect from the Suspension Date, the rights of all grantees to exercise their respective options shall forthwith be suspended. Upon such compromise, arrangement, amalgamation or merger becoming effective, all options shall, to the extent that they have not been exercised, lapse. The Board shall endeavor to procure that the Shares issued as a result of the exercise of options hereunder shall for the purposes of such compromise, arrangement, amalgamation or merger form part of the issued share capital of our Company on the effective date thereof and that such Shares shall in all respects be subject to such compromise, arrangement, amalgamation or merger. For a compromise or arrangement, if for any reason such compromise or arrangement is not approved by the court (whether upon the terms presented to the court or upon any other terms as may be approved by such court), the rights of grantees to exercise their respective options shall with effect from the date of the making of the order by the court be restored in full but only up to the extent not already exercised and shall thereupon become exercisable (but subject to the other terms of the Share Option Scheme) as if such compromise or arrangement had not been proposed by our Company and no claim shall lie against our Company or any of its officers for any loss or damage sustained by any grantee as a result of such proposal, unless any such loss or damage shall have been caused by the act, neglect, fraud or wilful default on the part of our Company or any of the officers.

(t) Lapse of options

An option shall lapse automatically on the earliest of:

- (i) the expiry of the period referred to in paragraph (i) above;
- (ii) the date on which the Board exercises our Company's right to cancel, revoke or terminate the option on the ground that the grantee commits a breach of paragraph (l);
- (iii) the expiry of the relevant period or the occurrence of the relevant event referred to in paragraphs (m), (o), (q), (r) or (s) above;
- (iv) subject to paragraph (r) above, the date of the commencement of the winding-up of our Company;
- (v) in the event that the grantee is an employee of our Group when an offer is made to him/her and he/she subsequently ceases to be an employee of our Group on any one or more of the grounds that he/she has been guilty of serious misconduct, or has committed an act of bankruptcy or has become insolvent or has made any arrangement or composition with his/her creditors generally, or has been convicted of any criminal offence involving his/her integrity or honesty or (if so determined by the Board) on any other ground on which an employer would be entitled to terminate his/her employment at common law or pursuant to any applicable laws or under the grantee's service contract with our Group, the date of cessation of his/her employment with our Group. A resolution of the Board or the board of directors of the relevant member of our Group to the effect that employment of a grantee has or has not been terminated on one or more of the grounds specified in this paragraph (v) shall be conclusive and binding on the grantee;
- (vi) the occurrence of any act of bankruptcy, insolvency or entering into of any arrangements or compositions with his creditors generally by the grantee, or conviction of the grantee of any criminal offence involving his integrity or honesty;
- (vii) where the grantee is only a substantial shareholder of any member of our Group, the date on which the grantee ceases to be a substantial shareholder of such member of our Group; or
- (viii) subject to the compromise or arrangement as referred to in paragraph (s) become effective, the date on which such compromise or arrangement becomes effective.

(u) Cancellation of options granted but not yet exercised

Any cancellation of options granted but not exercised may be effected on such terms as may be agreed with the relevant grantee, as the Board may in its absolute discretion sees fit and in manner that complies with all applicable legal requirements for such cancellation.

(v) Period of the Share Option Scheme

The Share Option Scheme will remain in force for a period of ten years commencing on the date on the Adoption Date and shall expire at the close of business on the business day immediately preceding the tenth anniversary thereof unless terminated earlier by the Shareholders in general meeting.

(w) Alteration to the Share Option Scheme

- (i) The Share Option Scheme may be altered in any respect by resolution of the Board except that alterations of the provisions of the Share Option Scheme which alters to the advantage of the grantees of the options relating to matters governed by Rule 17.03 of the Listing Rules shall not be made except with the prior approval of the Shareholders in general meeting.
- (ii) Any amendment to any terms and conditions of the Share Option Scheme which is of a material nature or any change to the terms of options granted, or any change to the authority of the Board in respect of alteration of the Share Option Scheme must be approved by Shareholders in general meeting except where the alterations take effect automatically under the existing terms of the Share Option Scheme.
- (iii) Any amendment to any terms of the Share Option Scheme or the options granted shall comply with the relevant requirements of Chapter 17 of the Listing Rules.

(x) Termination to the Share Option Scheme

Our Company may by resolution in general meeting or the Board at any time terminate the operation of the Share Option Scheme and in such event no further options will be offered but options granted prior to such termination shall continue to be valid and exercisable in accordance with provisions of the Share Option Scheme.

(y) *Conditions of the Share Option Scheme*

The Share Option Scheme is conditional upon the Hong Kong Stock Exchange granting the listing of, and permission to deal in, the Shares which may be issued pursuant to the exercise of any options which may be granted under the Share Option Scheme.

Present status of the Share Option Scheme

Application has been made to the Hong Kong Stock Exchange for the listing of and permission to deal in 72,397,931 Shares which fall to be issued pursuant to the exercise of options which may be granted under the Share Option Scheme.

As at the date of this prospectus, no option has been granted or agreed to be granted under the Share Option Scheme.

E. OTHER INFORMATION

1. Tax and other indemnity

The Controlling Shareholders (together, the “**Indemnifiers**”) have entered into the Deed of Indemnity to provide the following indemnities in favour of our Company (for itself and as trustee for each of the subsidiaries of our Company from time to time).

Under the Deed of Indemnity, the Indemnifiers have jointly and severally agreed, covenanted and undertaken to our Company (for itself and as trustee for its subsidiaries) that they will indemnify each member of our Group against (a) all damages, losses, claims, fines, penalties, charges, fees, costs, interests, expenses (including all legal costs and expenses), actions, proceedings, depletion of assets, loss of profit, loss of business, cost of rectification, costs of removal, costs of reinstatement of property (with reference to the physical and legal status of such property at the time when such property’s owner or user became a subsidiary of our Company) and any other liabilities of whatever nature (the “**Damages**”) which members of our Group may sustain, suffer, incur or be imposed by any regulatory authority or court in PRC, Hong Kong or any applicable jurisdiction as a result of any violation or non-compliance by any member of our Group with any applicable law, rule or regulation on all matters subsisting prior to the date on which the conditions set out in the section headed “Structure of the Global Offering — Conditions of the Hong Kong Public Offering” in this prospectus being fulfilled (the “**Effective Date**”); (b) taxation, together with all reasonable costs (including all legal costs), expenses or other liabilities which any member of our Group may incur in connection with (i) the investigation, assessment, contesting or settlement of any taxation claim under the Deed of Indemnity; (ii) any legal proceeding in relation to taxation claim in which any member of our Group claims under or in respect of the Deed of Indemnity and in which judgment is given for any member of our Group; or (iii) the enforcement of any such settlement or judgment falling on any member of our Group resulting from or by reference to any income, profits or gains, transactions, events, acts, omissions, matters or things earned, accrued or received, entered into (or deemed to be so earned, accrued, received or entered into)

or occurring on or before the Effective Date whether alone or in conjunction with any circumstances whenever occurring and whether or not such taxation is changeable against or attributable to any other person, firm or company; (c) any liability for Hong Kong estate duty which might be incurred by any member of our Group and/or its associated companies by reason of any transfer of property (within the meaning of sections 35 and 43 of the Estate Duty Ordinance (Chapter 111 of the Laws of Hong Kong (the “**Estate Duty Ordinance**”)) or the equivalent thereof under the laws of any jurisdiction outside Hong Kong) to any member of our Group on or before the Effective Date; (d) all or any Damages which members of our Group may sustain, suffer and incur as a result of directly or indirectly or in connection with any litigation, proceeding, claim, investigation, inquiry, enforcement proceeding or process by any governmental, administrative or regulatory body which (i) any member of our Group, their respective directors and/or representatives or any of them is/are involved; and/or (ii) arises due to some act or omission of, or transaction voluntarily effected by, any member of our Group or any of them (whether alone or in conjunction with some other act, omission or transaction) on or before the Effective Date; and (e) all or any Damages which members of our Group may sustain, suffer and incur arising from or in connection with the title defects of the properties owned by or leased by any member of our Group (either due to non-registration of the lease agreements or any other reasons) in any jurisdiction which were occurred on or before the Effective Date.

The Indemnifiers will not, however, be liable under the Deed of Indemnity (a) to the extent that allowance, provision or reserve has been made for taxation in the audited accounts of our Group for the Track Record Period; (b) to the extent that taxation claim arises or is incurred as a result of the imposition of taxation as a consequence of any introduction of new legislation or any retrospective change in law or the interpretation or practice by the relevant tax authority coming into force after the Effective Date or to the extent that the taxation claim arises or is increased by an increase in rates of taxation after the Effective Date with retrospective effect; (c) for which any member of our Group is liable as a result of any event occurring or income, profits earned, accrued or received or alleged to have been earned, accrued or received or transactions entered into in the ordinary course of business on or before the Effective Date; (d) to the extent that such taxation or liability would not have arisen but for any act or omission by any member of our Group (whether alone or in conjunction with some other act, omission or transaction, whenever occurring) voluntarily effected without the consent of the Indemnifiers and otherwise than in the ordinary course of business on or before the Effective Date; (e) to the extent of any allowance or provision or reserve made for taxation in the audited accounts of our Group for the Track Record Period, which is finally established to be an over-allowance or over-provision or an excessive reserve provided that the amount of any such allowance or provision or reserve applied to reduce the Indemnifiers’ liability in respect of taxation shall not be available in respect of any such liability arising thereafter; (f) to the extent that the taxation claim arises or is incurred as a consequence of a change in any accounting policy or practice adopted by any other member of our Group after the Effective Date; (g) to the extent that any member of our Group shall have admitted liability in respect of the circumstances giving rise to

the claim for taxation after the Effective Date; or (h) to the extent that any penalty is imposed on our Group under section 42 of the Estate Duty Ordinance by reason of our Company defaulting in any obligation to give information.

Our Directors have been advised that no material liability for estate duty would be likely to fall upon our Company or any of its subsidiaries in Bermuda, the BVI, PRC and Hong Kong.

2. Litigation or claims

Save as disclosed in the section headed “Business — Legal Proceedings and Compliance” in this prospectus, as of the Latest Practicable Date, no member of our Group was subject to any actual, pending or threatened litigation or claims of material importance which would have a material impact on our Group’s operations, financials and reputation.

3. The Joint Sponsors

The Joint Sponsors have made an application on our behalf to the Listing Committee for the listing of, and permission to deal in, all the Shares in issue and to be issued as mentioned in this prospectus (including any Shares which may be issued upon the exercise of the Over-allotment Option or options which may be granted under the Share Option Schemes).

BOCI Asia Limited does not satisfy the independence criteria applicable to sponsors set out in Rule 3A.07 of the Listing Rules because certain portion of the proceeds from the sale of Sale Shares by the Selling Shareholder (which amounts to 15% or more of the proceeds raised from the initial public offering of our Company) will be used directly or indirectly to settle debts of the Selling Shareholder due to Bank of China (Hong Kong) Limited, being a subsidiary of Bank of China Limited of which BOCI Asia Limited is a subsidiary, and therefore a member of the sponsor group (as defined in Rule 3A.01(9) of the Listing Rules).

BOSC International Company Limited satisfies the independence criteria applicable to sponsors set out in Rule 3A.07 of the Listing Rules.

The Joint Sponsors’ fees are an aggregate fee of approximately HK\$8.24 million and are payable by our Company.

4. Preliminary expenses

We have not incurred any preliminary expenses.

5. Promoters

Our Company does not have promoter. Within the two years immediately preceding the date of this prospectus, no cash, securities or other benefit has been paid, allotted or given or is proposed to be paid, allotted or given to any promoter in connection with the Global Offering and the related transactions described in this prospectus.

6. Qualification of experts

The qualifications of the experts (as defined under the Companies (Winding Up and Miscellaneous Provisions) Ordinance and the Listing Rules) who have given their opinions or advice in this prospectus are as follows:

Expert	Qualification
BOCI Asia Limited	A corporation licensed under the SFO to carry on type 1 (dealing in securities) and type 6 (advising on corporate finance) regulated activities
BOSC International Company Limited	A corporation licensed under the SFO to carry on type 1 (dealing in securities), type 4 (advising on securities), type 6 (advising on corporate finance) and type 9 (asset management) regulated activities
JunHe LLP	Legal advisers to our Company as to PRC law
Appleby	Legal advisers to our Company as to Bermuda law
Mr. Matthew L.C. Ho	Barrister-at-law of Hong Kong
Ernst & Young	Certified Public Accountants
Jones Lang LaSalle Corporate Appraisal and Advisory Limited	Property valuer
Frost & Sullivan Limited	Industry Consultant
Benny Pang & Co	Legal adviser to our Company as to Hong Kong law

None of the experts named above has any shareholding in any member of our Group or the right (whether legally enforceable or not) to subscribe for or to nominate persons to subscribe for securities in any members of our Group.

7. Consents of experts

Each of the above experts has given and has not withdrawn its written consent to the issue of this prospectus with its statements, all of which are dated the date of this prospectus and made for incorporation in this prospectus, and references to its name included in this prospectus in the form and context in which it is included.

8. Miscellaneous

Save as disclosed in this prospectus:

- (a) none of the Directors nor any of the parties listed in the section headed “E. Other information — 6. Qualification of experts” in this appendix has any direct or indirect interest in the promotion of, or in any assets which have been, within the two years immediately preceding the date of this prospectus, acquired or disposed of by or leased to, any member of our Group, or are proposed to be acquired or disposed of by or leased to any member of our Group;
- (b) none of the Directors is materially interested in any contract or arrangement subsisting at the date of this prospectus which is significant in relation to the business of our Group;
- (c) no capital of any member of our Group is under option, or agreed conditionally or unconditionally to be put under option;
- (d) our Company has not issued or agreed to issue any founder or management or deferred Shares;
- (e) our Group has no outstanding debentures or convertible debt securities;
- (f) there has not been any interruption in the business of our Group which may have or has had a significant effect on the financial position of our Group in the 12 months preceding the date of this prospectus;
- (g) there is no arrangement under which future dividends are waived or agreed to be waived;
- (h) no commissions, discounts, brokerages or other special terms were granted within the two years immediately preceding the date of this prospectus in connection with the issue or sale of any capital of any member of our Group, and none of the Directors nor any of the parties listed in the section headed “E. Other information — 6. Qualification of experts” in this appendix has received any such payment or benefit;

- (i) within the two years immediately preceding the date of this prospectus, no commission (but not including commission to the Underwriters) had been paid or payable for subscribing or agreeing to subscribe, or procuring or agreeing to procure subscriptions, for any share in or debenture of our Company; and
- (j) in case of discrepancy, the English version of this prospectus shall prevail over the Chinese version.

9. Binding effect

This prospectus shall have the effect, if an application is made in pursuance of this prospectus, of rendering all persons concerned bound by all the provisions (other than the penal provisions) of Sections 44A and 44B of the Companies (Winding Up and Miscellaneous Provisions) Ordinance so far as applicable.

10. Bilingual prospectus

The English version and the Chinese version of this prospectus are being published separately in reliance upon the exemption provided by Section 4 of the Companies (Exemption of Companies and Prospectuses from Compliance with Provisions) Notice (Chapter 32L of the Laws of Hong Kong).

11. Particulars of the Selling Shareholder

The particulars of the Selling Shareholder are set out below:

Name:	Hero Valour Limited
Place of incorporation:	BVI
Date of incorporation:	April 11, 2013
Registered office:	Vistra Corporate Services Centre, Wickhams Cay II, Road Town, Tortola, VG1110, British Virgin Islands
Number of the Sale Shares to be sold:	132,970,688 Shares

The Selling Shareholder is an investment holding company and is wholly-owned by Mr. Wong.

APPENDIX V**DOCUMENTS DELIVERED TO THE REGISTRAR
OF COMPANIES AND AVAILABLE FOR INSPECTION**

DOCUMENTS DELIVERED TO THE REGISTRAR OF COMPANIES IN HONG KONG

The documents attached to a copy of this prospectus delivered to the Registrar of Companies in Hong Kong for registration were:

- (a) a copy of each of the **WHITE, YELLOW, GREEN** and **PINK** Application Forms;
- (b) the written consents referred to in the section headed “E. Other information — 7. Consents of experts” in Appendix IV to this prospectus;
- (c) a copy of each of the material contracts referred to in the section headed “B. Further information about the business of our Group — 1. Summary of material contracts” in Appendix IV to this prospectus; and
- (d) the statement of particulars of the Selling Shareholder.

DOCUMENTS AVAILABLE FOR INSPECTION

Copies of the following documents will be available for inspection at the office of Benny Pang & Co at 27/F, 100QRC, 100 Queen’s Road Central, Central, Hong Kong during normal business hours up to and including the date which is 14 days from the date of this prospectus:













- (a) the Memorandum and the Bye-Laws;
- (b) the service agreements and appointment letters referred to in the section headed “C. Further information about our Directors — 3. Particulars of service agreements and appointment letters” in Appendix IV to this prospectus;
- (c) the material contracts referred to in the section headed “B. Further information about the business of our Group — 1. Summary of material contracts” in Appendix IV to this prospectus;
- (d) the written consents referred to in the section headed “E. Other information — 7. Consents of experts” in Appendix IV to this prospectus;
- (e) the legal opinions issued by the PRC Legal Advisers;
- (f) the legal opinion issued by Benny Pang & Co;
- (g) the legal opinion issued by the Hong Kong Special Counsel;
- (h) the letter issued by Appleby, being the legal advisers to our Company as to Bermuda law, summarising certain aspects of the Bermuda company law as referred to in Appendix III to this prospectus;

APPENDIX V**DOCUMENTS DELIVERED TO THE REGISTRAR
OF COMPANIES AND AVAILABLE FOR INSPECTION**

- (i) the Accountants' Report issued by Ernst & Young, being our Company's reporting accountants, the text of which is set out in Appendix I to this prospectus;
- (j) the statement of adjustment made by Ernst & Young in arriving at the figures set out in the Accountants' Report in Appendix I to this prospectus;
- (k) the report issued by Ernst & Young, being our Company's reporting accountants, relating to the unaudited pro forma financial information, the text of which is set out in Appendix II to this prospectus;
- (l) the audited consolidated financial statements of our Company for the years ended December 31, 2015, 2016 and 2017;
- (m) the fair rent report issued by JLL;
- (n) the Frost & Sullivan Report;
- (o) the Companies Act;
- (p) the rules of the Pre-IPO Share Option Scheme;
- (q) the rules of the Share Option Scheme;
- (r) the list of the grantees who have been conditionally granted options to subscribe for Shares under the Pre-IPO Share Option Scheme, containing all details as required under the Listing Rules and the Companies (Winding Up and Miscellaneous Provisions) Ordinance; and
- (s) the statement of particulars of the Selling Shareholder.











(a) TRADEMARKS

As of the Latest Practicable Date, our Group was the registered proprietor of the following trademarks in Hong Kong which, in the opinion of our Directors, are material to our business:

	Trademark	Registration No.	Class	Name of Registered Proprietor	Date of Registration	Expiry Date
1.		19860727	29	TWIC	20/03/1986	19/02/2026
2.		19791614	30	TWIC	20/12/1979	14/12/2023
3.	<i>Our Pride</i>	1984B1108	30	TWIC	29/05/1984	08/10/2025
4.	ADMIRAL	19860724AA	29, 30	TWIC	20/03/1986	19/02/2026
5.	GENERAL	199204978	30	TWIC	03/12/1992	03/07/2022
6.	福將牌	19860728AA	29, 30	TWIC	20/03/1986	19/02/2026
7.	藍寶	200101875	30	TWIC	16/02/2001	26/07/2027
8.	特味佳	2001B13712AA	29, 30	TWIC	07/12/2001	21/02/2028
9.	 	300588880	29, 30	TWIC	09/08/2006	26/02/2026
10.	 TWG  TWG	302627712	11, 21, 32, 35, 43	TWIC	03/06/2013	02/06/2023
11.	 TWG  TWG	300635463	29, 30	TWIC	02/11/2006	08/05/2026
12.	 TWG 捷榮集團  TWG 捷榮集團	300635472	30	TWIC	23/07/2007	08/05/2026
13.	 捷榮集團  捷榮集團	300635481	29, 30	TWIC	23/07/2007	08/05/2026







APPENDIX VI

INTELLECTUAL PROPERTY RIGHTS



	Trademark	Registration No.	Class	Name of Registered Proprietor	Date of Registration	Expiry Date
14.		302627703	11, 21, 32, 35, 43	TWIC	03/06/2013	02/06/2023
15.		300655470	29, 30	TWIC	06/12/2006	07/06/2026
16.		302342673	11	TWIC	10/08/2012	09/08/2022
17.		302627695	21, 32, 35, 43	TWIC	03/06/2013	02/06/2023
18.		301264752	30	TWIC	29/12/2008	28/12/2018
19.		301375939	29	TWIC	02/07/2009	01/07/2019
20.		301387170	30	TWIC	16/12/2009	16/07/2019
21.		301517571	29, 30	TWIC	07/01/2010	06/01/2020
22.	TWG	302627721	11	TWIC	03/06/2013	02/06/2023
23.	TWG	302134845	21, 29, 30, 32, 35, 43	TWIC	10/01/2012	09/01/2022
24.	TW	302158416	30, 32, 43	TWIC	10/02/2012	09/02/2022
25.	捷榮 捷榮	302158425	30, 32, 43	TWIC	10/02/2012	09/02/2022
26.		303859985	21	TWIC	04/08/2016	03/08/2026
27.		303859949	29	TWIC	04/08/2016	03/08/2026

APPENDIX VI

INTELLECTUAL PROPERTY RIGHTS















	Trademark	Registration No.	Class	Name of Registered Proprietor	Date of Registration	Expiry Date
28.		303859930	35	TWIC	04/08/2016	03/08/2026
29.		303894562	21, 30, 41	TWIC	06/09/2016	05/09/2026
30.		302756782	29	Whole Sun	04/10/2013	03/10/2023
31.		303859471	29	TWIC	04/08/2016	03/08/2026
32.		303859480	21	TWIC	04/08/2016	03/08/2026
33.		303859516	35	TWIC	04/08/2016	03/08/2026
34.		304171473	21, 30, 41	TWIC	14/06/2017	13/06/2027

As of the Latest Practicable Date, our Group was the registered proprietor of the following trademarks in the PRC which, in the opinion of our Directors, are material to our business:

	Trademark	Registration No.	Class	Name of Registered Proprietor	Date of Registration	Expiry Date
1.	捷荣	1349226	29	TWIC	28/12/1999	27/12/2019
2.	捷荣	1366404	30	TWIC	21/02/2000	20/02/2020
3.	捷荣	10493671	29	TWIC	07/09/2013	06/09/2023
4.	捷荣	10493670	30	TWIC	07/09/2013	06/09/2023
5.	捷荣	10493669	32	TWIC	07/04/2013	06/04/2023
6.	捷荣	10493668	35	TWIC	07/04/2015	06/04/2025
7.		2018344	30	TWIC	21/01/2003	20/01/2023
8.		3101373	30	TWIC	14/04/2003	13/04/2023

















APPENDIX VI

INTELLECTUAL PROPERTY RIGHTS

	Trademark	Registration No.	Class	Name of Registered Proprietor	Date of Registration	Expiry Date
9.		10505698	35	TWIC	14/07/2017	13/07/2027
10.	 捷榮集團	5337773	29	TWIC	21/04/2009	20/04/2019
11.	 捷榮集團	5337772	30	TWIC	28/04/2009	27/04/2019
12.	 TWG 捷榮集團	10774483	30	TWIC	07/04/2015	06/04/2025
13.	 TWG 捷榮集團	10786945	32	TWIC	14/08/2015	13/08/2025
14.	 TWG	5337774	30	TWIC	07/07/2009	06/07/2019
15.	 捷榮集團	5344973	29	TWIC	21/04/2009	20/04/2019
16.	 捷榮集團	5344972	30	TWIC	28/04/2009	27/04/2019
17.	 TWG	5344974	30	TWIC	07/07/2009	06/07/2019
18.		5409038	29	TWIC	14/03/2012	13/03/2022
19.		5409037	30	TWIC	28/07/2009	27/07/2019
20.		5414434	29	TWIC	14/08/2010	13/08/2020
21.		5414435	30	TWIC	28/07/2009	27/07/2019
22.	 捷榮	11428184	11	TWIC	14/03/2014	13/03/2024
23.	 捷榮	7990336	29	TWIC	21/03/2011	20/03/2021









APPENDIX VI

INTELLECTUAL PROPERTY RIGHTS

	Trademark	Registration No.	Class	Name of Registered Proprietor	Date of Registration	Expiry Date
24.		7990335	30	TWIC	07/02/2011	06/02/2021
25.		18085829	32	TWIC	28/11/2016	27/11/2026
26.		11448572	11	TWIC	14/04/2015	13/04/2025
27.		7517524	29	TWIC	14/02/2011	13/02/2021
28.		7231692	30	TWIC	07/10/2010	06/10/2020
29.		7522256	29	TWIC	21/02/2011	20/02/2021
30.		7236277	30	TWIC	21/02/2011	20/02/2021
31.		7671973	30	TWIC	28/06/2014	27/06/2024
32.		7762220	30	TWIC	21/04/2014	20/04/2024
33.		10268225	30	TWIC	07/02/2013	06/02/2023
34.	福將牌	10268226	30	TWIC	14/03/2013	13/03/2023
35.	ADMIRAL	10476083	30	TWIC	14/07/2014	13/07/2024
36.		10493656	29	TWIC	07/09/2013	06/09/2023
37.		10493655	30	TWIC	07/09/2013	06/09/2023
38.		10493654	32	TWIC	07/04/2013	06/04/2023
39.		10493653	35	TWIC	07/04/2015	06/04/2025
40.		10505701	29	TWIC	14/04/2013	13/04/2023
41.		10505700	30	TWIC	14/04/2013	13/04/2023



APPENDIX VI

INTELLECTUAL PROPERTY RIGHTS

	Trademark	Registration No.	Class	Name of Registered Proprietor	Date of Registration	Expiry Date
42.		10505698	35	TWIC	14/07/2017	13/07/2027
43.		10505699	32	TWIC	14/04/2013	13/04/2023
44.		10493661	29	TWIC	21/08/2013	20/08/2023
45.		10493660	30	TWIC	21/08/2013	20/08/2023
46.		10493659	32	TWIC	14/07/2014	13/07/2024
47.		10493658	35	TWIC	14/03/2014	13/03/2024
48.		10505696	29	TWIC	14/04/2013	13/04/2023
49.		10505695	30	TWIC	14/04/2013	13/04/2023
50.		10505694	32	TWIC	14/04/2013	13/04/2023
51.	TWG	10493666	29	TWIC	14/03/2014	13/03/2024
52.	TWG	10493665	30	TWIC	07/04/2015	06/04/2025
53.	TWG	10493664	32	TWIC	07/04/2015	06/04/2025
54.	TWG	10493663	35	TWIC	07/04/2015	06/04/2025
55.	TWG	13230581	30	TWIC	21/03/2015	20/03/2025
56.	TSIT WING	10774489	29	TWIC	28/06/2013	27/06/2023
57.	TSIT WING	10774488	30	TWIC	28/06/2013	27/06/2023
58.	TSIT WING	10774487	32	TWIC	28/06/2013	27/06/2023
59.	TSIT WING	10774486	35	TWIC	28/06/2013	27/06/2023
60.		11804059	35	TWIC	14/05/2015	13/05/2025
61.		20342638	30	TWIC	07/08/2017	06/08/2027

APPENDIX VI





INTELLECTUAL PROPERTY RIGHTS

	Trademark	Registration No.	Class	Name of Registered Proprietor	Date of Registration	Expiry Date
62.		20342728	35	TWIC	07/08/2017	06/08/2027
63.		20343253	29	TWIC	07/08/2017	06/08/2027
64.		20343367	29	TWIC	07/08/2017	06/08/2027
65.	PapaChef	20343490	30	TWIC	21/10/2017	20/10/2027
66.	捷荣蓝宝	4686113	30	Company	07/03/2008	06/03/2028

As of the Latest Practicable Date, the following trademarks of our Group had expired and the renewal applications were under processing:

	Trademark	Registration No.	Class	Name of Registered Proprietor	Date of Registration	Expiry Date	Date of submission of renewal application
1.	捷荣锦标	4686111	30	Company	07/03/2008	06/03/2018	February 24, 2018
2.	捷荣紫荆	4686112	30	Company	07/03/2008	06/03/2018	February 24, 2018
3.	捷荣红宝	4686114	30	Company	07/03/2008	06/03/2018	February 24, 2018

As of the Latest Practicable Date, our Group had applied for registration of the following trademarks in the PRC:

	Trademark	Application No.	Class	Applicant	Application Date
1.		14817350	30	TWIC	10/06/2014
2.		20342895	29	TWIC	17/06/2016
3.		24234647	30	TWIC	19/05/2017
4.		24234634	41	TWIC	19/05/2017

(b) DOMAIN NAMES

As of the Latest Practicable Date, our Group was the registered proprietor of the following domain names which, in the opinion of our Directors, are material to our business:

Domain Name	Name of Registered Proprietor	Date of Registration	Expiry Date
捷榮.cn	COFE	December 22, 2004	December 22, 2019
捷榮咖啡.cn	COFE	December 22, 2004	December 22, 2019
捷榮集團.cn	COFE	July 12, 2005	July 12, 2020
捷榮食品.cn	COFE	September 24, 2005	September 24, 2020
捷榮中國.cn	COFE	March 25, 2009	March 25, 2019
捷榮啡茶.cn	COFE	March 25, 2009	March 25, 2019
tsitwing.hk	Company	December 9, 2004	December 18, 2020
twcoffee.hk	Company	December 9, 2004	December 18, 2020
twcoffee.com.hk	Company	December 8, 2004	December 18, 2020
twg.com.hk	Company	May 19, 2006	May 24, 2022
twg.hk	Company	May 19, 2006	May 20, 2022
twcoffee.com	COFE	March 24, 1997	March 25, 2020
twcoffee.com.cn	Company	March 9, 2007	March 9, 2026
coffeasia.com	COFE	February 9, 2000	February 9, 2021
shtsitwing.com	Company	August 24, 2006	August 24, 2026
tsitwingcafe.com	COFE	September 2, 2003	September 2, 2027
zhtsitwing.com	COFE	September 2, 2003	September 2, 2027
tsitwing.com	COFE	December 8, 2004	December 8, 2027
tsitwing.com.cn	COFE	July 18, 2012	July 18, 2022
tsitwing.cn	COFE	July 18, 2012	July 18, 2022
捷榮食品.com	Company	November 27, 2009	November 27, 2019

APPENDIX VI

INTELLECTUAL PROPERTY RIGHTS

Domain Name	Name of Registered Proprietor	Date of Registration	Expiry Date
捷榮集團.com	Company	November 27, 2009	November 27, 2019
捷榮咖啡.com	Company	November 27, 2009	November 27, 2019
捷榮食品.公司	COFE	August 21, 2014	August 20, 2020
捷榮咖啡.公司	COFE	August 21, 2014	August 20, 2020
捷榮集團.公司	COFE	August 21, 2014	August 20, 2020
cadiz.hk	CDEL	July 27, 2011	July 27, 2021
cadiz.com.hk	CDEL	July 27, 2011	July 27, 2021
wholesun.com.hk	Whole Sun	March 20, 2013	March 20, 2023